

HANSA FLEX

汉萨福莱柯思

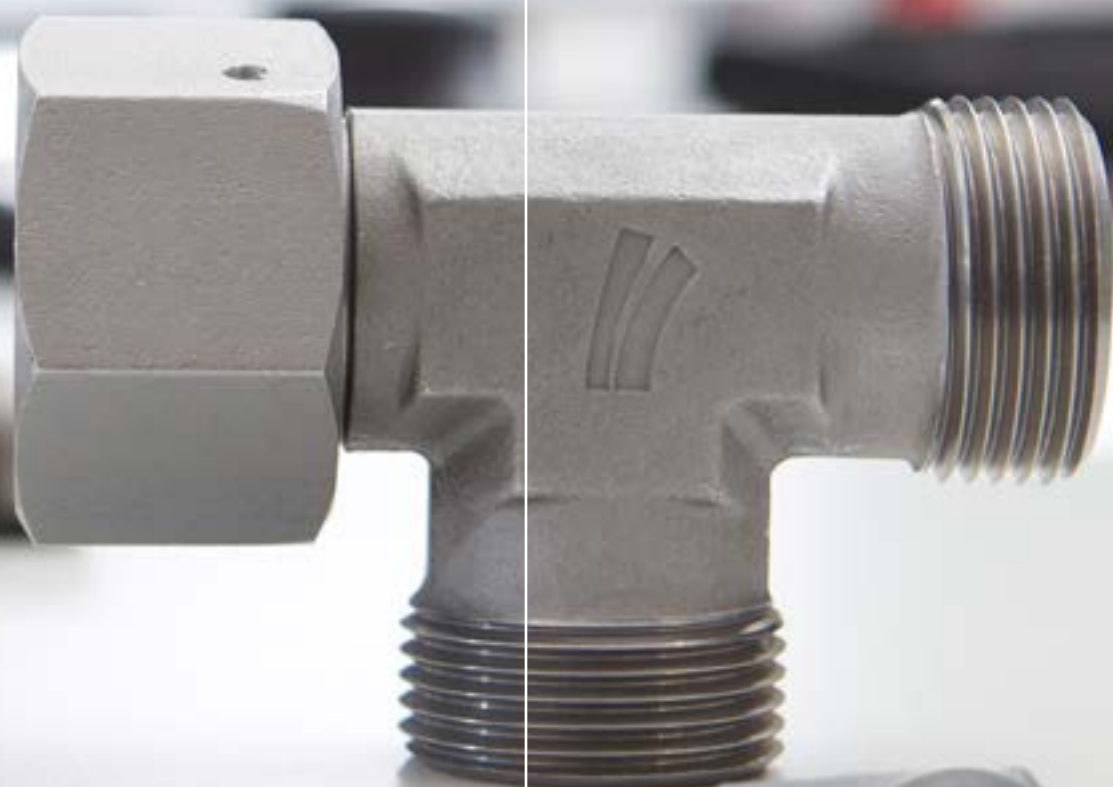

卡套式管接头

HANSA-FLEX简介

HANSA-FLEX 于 1962 年成立于德国北部城市不莱梅，经过 50 多年的发展，已经逐步在欧洲液压产品供应商之中占据了重要地位。

HANSA-FLEX 作为工程机械行业液压流体连接件产品的重要供应商，高品质产品涵盖了胶管总成、接头、球阀、硬管总成、快速接头、法兰、管夹等。

同时 HANSA-FLEX 作为提供系统解决方案的合作伙伴，HANSA-FLEX 专业提供复杂液压系统解决方案，也提供一系列的液压服务，包括提供液压备件，液压系统总成，安装，调试，交付使用，产品培训等。

在中国，HANSA-FLEX 拥有自己的独资子公司，在上海建立了大型的物流中心，并逐步将其发展成为除德国不莱梅总部之外的第二个具有总部核心作用的中国区总部。作为 HANSA-FLEX 在中国区和亚太区扩大发展的基地，未来几年我们的业务将辐射至整个亚太区乃至全球分厂。

HANSA-FLEX 在中国总部成立于2004年，在上海临港新城建立了大型物流中心和生产基地，之下设立了5个分支机构，分别分布在北京，广州，武汉，常州，青岛和成都，为中国客户提供完善和专业的液压服务。

HANSA-FLEX AG was founded in 1962 in Bremen, after over 50 years' development, Hansa-Flex has become an European leading company for all areas of hydraulics.

HANSA-FLEX AG is one of the most important suppliers for hydraulic connection components in the construction machinery industry, our high quality products include hose lines, fittings, flange, couplings, hydraulic units&systems, etc.

As a system partner Hansa-Flex is an expert in the overall complex system of fluid technology and offers a full range of integrated services:from the supply of fastening elements and assemblies to commissioning and training of operators.

HANSA-FLEX Hydraulic Shanghai Co.,Ltd is a wholly-owned subsidiary of HANSA-FLEX AG, and started its operation in China since 2004.A large central warehouse and several production workshops are built in Shanghai Ling gang, as the base of China and Asia-Pacific area. Besides Hansa-Flex Shanghai, 5 branches have been set up in Beijing, Guangzhou, Wuhan and Changzhou, Qingdao and Chengdu,which provide convenient hydraulic products and services for customers around.



德国总部



中国总部



卡套式接头产品一览	2
卡套式管接头技术说明	
1. 卡套式管接头的基本结构和原理	5
2. 一般技术资料	5
3. 油口螺纹及密封形式	7
4. 卡套管接头的管端尺寸	11
5. 管接头的旋紧力矩	12
6. 精密无缝钢管	12
7. 管接头的装配须知	12
8. 37° 扩口管接头的装配	14
9. 焊接管接头的装配	14
10. 螺纹表格	15
11. 如何订购接头	17
卡套式管接头选型	18
旋转式接头技术资料	83
旋转式接头选型	83
精密钢管选型	96

卡套和螺母



普通卡套 SRD P18



特殊卡套 SRDO V P18



螺母 UEM P19



扁螺母 KM P19



软密封 SRWD-VI P20

钢管与钢管连接



XV 直通 P20



XW 直角 P22



XT 三通 P22



XRT 三通变径 P23



XK 四通 P25

油口连接



端直通

英制螺纹 XVR* P25
公制螺纹 XVM* P29
NPT 螺纹 XVN P33
UNF 螺纹 XVU P34



端直角

英制螺纹 XWR* P35
公制螺纹 XWM* P36
NPT 螺纹 XWN P37



L 型端三通

XLR* P38
XLM* P39
XLN P40

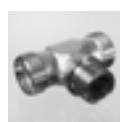

T 型端三通

XTR* P40
XTM* P41
XTN P42



端直通接插件

AOVR* P42
AOVM-ED P44
AOVN P44

24°锥可调式管接头



24°锥可调式直通

XAOH P45



24°锥可调式弯通

XVEWO45 P49



XVEWO P49



24°锥可调式(L型)

XVELO P50



XVEL P50



24°锥可调式(T型)

XVETO P51



XVET P51



端对接组合

DMO P52



DMO45 P54

可调向弯通接头



可调向 45°

英制螺纹 XEWOR*45 P54
公制螺纹 XEWOM*45 P55



可调向直角

XEWOR* P56
XEWOM* P57
XEWO P58



可调向 L 型三通

XELOR* P59
XELOM* P60
XELO P61



可调向 T 型三通

XETOR* P62
XETOM* P63
XETO P64

* 代表省略部分型号代码

隔板接头



英制螺纹 XSVR-ED P64
公制螺纹 XSVM P65



XSV P65



XSW P66

焊接接头



SA-DKOL P66
SA-DKO P67



XSA P68



XWSA P68



XSE P69

油口变径连接



RIK P69
RIK-ED P70



RIL P70
RIL-ED* P71

内螺纹连接



英制螺纹 XGAR P72
公制螺纹 XGAM P73

压力表接头



XMVR P73



MVO P74

铰接式接头



低压

英制螺纹 XDWR P74
公制螺纹 XDWM P75



高压

XSWR P75
XSWM P76



高压 (带旁通回路)

XSDOR P76
XSDOM P77



XSDR P77
XSDM P78

堵头



BZL+BZS P78



英制螺纹 VHR90 P79
公制螺纹 VHM90 P79



VHMO 90 P80

单向阀



XRD P80



英制螺纹 XHVR-ED P81
公制螺纹 XHVM-ED P81



XHZR-ED P82
XHZM-ED P82

旋转接头



DG P84
DG H P84



DG 90 P85
DG D P85



DGR P85
DGR H P86



DGR 90 P86
DGM 90 P88



DGM P87
DGM H P87



DGS P88
DGS H P89
DGS 90 P89



GVR P90
GVM P90



GV 90 H P91
DG D H P91



GVR 90 P92
GVM 90 P93
GVR 90 H P92
GVM 90 H P94

密封圈



WD P94

钢管



PR P95
PRVZ P96
PRV1 P97
PRV2 P97
PRV4 P98

* 代表省略部分型号代码

1. 卡套式管接头的基本结构和原理

多年来，HANSA-FLEX公司生产的管接头已经以其严格的制造标准及工艺广泛应用于冶金，造船，轨道交通等各个工程领域。我们的管接头是根据DIN EN ISO 8434-1 和 DIN 2353标准制造的。同时，卡套的几何尺寸及材料特性也保证了牢固的连接与可靠的密封，通过与管接头体的正确安装后，实现了液压管路的基本功能，并且只有遵守每一项安装规范，才能防止液压介质泄漏，使液压系统长期持久可靠的工作。

装配工作可以在管接头的本体上进行，或者在装配模具中进行（大批量安装建议使用装配机器）。

当旋紧螺母的时候，HANSA-FLEX公司的渐进式卡套的切削刃就沿着轴线方向，朝24°的锥形区域移动。在一定的力矩作用下使切削刃咬入管子的表面，并形成稳定的材料凸缘，实现了卡套的预安装。

卡套本身止档的结构，在最终安装时会形成力矩激增，从而保证液压管子的变形限制在必要的范围内。

卡套的弹性作用是管接头的一个能够减小振动的重要特性，过大振动往往会导致管接头泄漏。

管接头可以进行重复装配，详见使用说明书。

为了满足客户提出的增强防泄漏能力的要求，HANSA-FLEX公司目前的产品范围也包括了附带弹性密封体的卡套。这种特殊卡套的装配方法和普通卡套相同，但是它们具有更高的防泄漏特性。

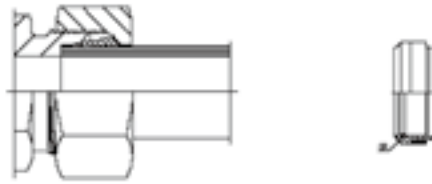

2. 一般技术资料

本样本中提及的所有管接头都是按照DIN 2352 和 DIN EN ISO 8434ff标准制造的，并且适用于液压技术系统。

HANSA-FLEX公司的产品范围包含了工业标准以外的种类繁多的各种管接头。这些的特殊管接头（例如具有级差规格尺寸的管接头），倚靠它们特殊的端口，可以和各种工业标准件连接，并且保证良好的互换性。

HANSA-FLEX公司的管接头能够满足各个相关标准要求的各个等级的名义压力，而有些规格的管接头还能够满足更高的压力等级。

用户务必注意，为了使管接头安全和可靠的工作，用户必须严格遵循本样本规定的装配须知。

2.1 材料

HANSA-FLEX公司的管接头是使用锻造碳钢，或者冷轧碳钢制成，符合DIN3859标准对管接头的技术要求。

2.2 表面处理

HANSA-FLEX公司的碳钢管接头本体、螺母和卡套的表面经过标准镀锌处理，符合ISO 4042标准的要求。

ISO 4042标准是一个广泛使用的有关表面保护标准，在良好的抗腐蚀能力和防止环境的不良影响方面，对保护表面提出了要求。

HANSA-FLEX公司的焊接管接头的表面覆盖了深灰色的磷化层和油面层，以便进行焊接和钎焊。

2.3 温度等级

HANSA-FLEX公司管接头的设计工作温度范围为-40°C至+200°C。

但是在使用附加的弹性体密封件的情况下，必须考虑橡胶弹性体的耐高温性能。

请用户注意下列零部件的工作温度范围：

碳钢管接头	-40°C 至 +200°C
带丁腈橡胶（NBR）密封件的碳钢管接头	-35°C 至 +100°C
带氟橡胶（FPM）密封件的碳钢管接头	-25°C 至 +200°C
不锈钢管接头	-60°C 至 +400°C

标准弹性体密封件：丁腈橡胶（NBR）密封件。对于更高的工作温度，我们建议采用氟橡胶（FPM）密封件。

温度	压力降低
- 60°C至+20°C	-
+50°C	4 %
+100°C	11 %
+200°C	20 %
+300°C	29 %
+400°C	33 %

2.4 工作压力

根据允许的工作压力和使用场合，HANSA-FLEX公司管接头可以分为下列三个主要类别：

LL：特轻型系列管接头

L：轻型系列管接头

S：重型系列管接头

管接头也经常按照它们的公称压力PN和工作压力PB的级别来分类。

公称压力PN仅仅用来对液压系统进行分类，其设计系数为4。

工作压力PB由材料的性能决定，并且可以根据允许的工作温度计算出来。工作压力决定了部件允许的最高工作压力。

但是，除非另有规定，根据工作压力PB分类的HANSA-FLEX公司的管接头的设计系数为2.5。

37°扩口管接头的设计系数为4。

但是，为了达到液压系统安全和可靠工作的目的，要求正确装配管接头和卡套，并且要求液压系统的管道正确定位。

另外，我们也必须指出，对于某些名义压力规格来说，HANSA-FLEX公司的管接头的压力实际上已经超过了DIN EN 8434-1标准要求的压力等级。总之，本书提及的最大压力只针对管接头本身，实际最大工作压力还须注意钢管的壁厚和质量。

工作压力

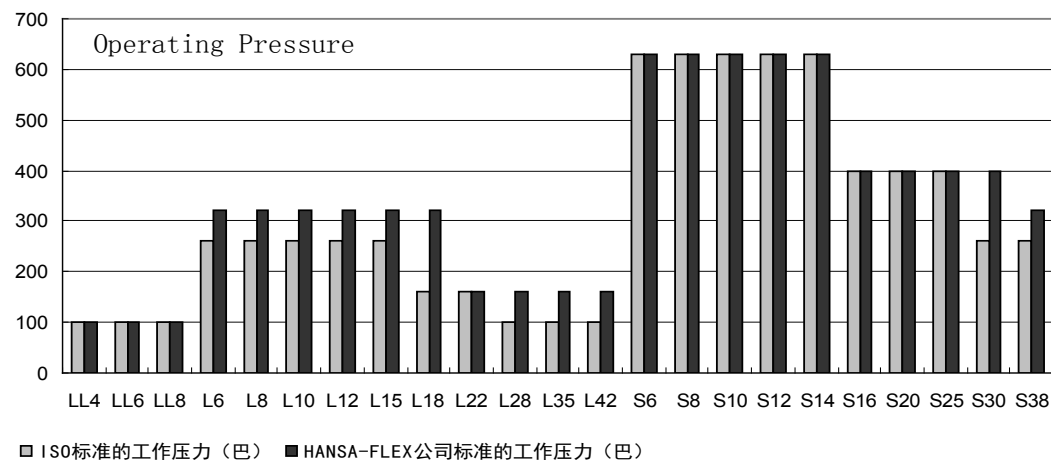

3. 油口螺纹及密封形式

HANSA-FLEX公司管接头可以有各种标准螺纹，从而适用于各种不同的用途。

a) 公制螺栓端部和端口的螺纹符合DIN3852标准第1部分的形式B和DIN3852第11部分的形式E，而其端口螺纹则符合上述标准的形式X。

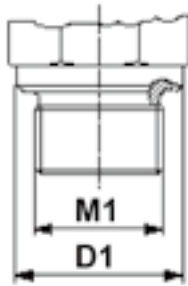

DIN3852-1 形式B
ISO1179-4 硬密封结构

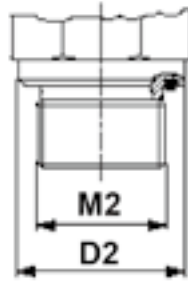

DIN3852-11 形式E
ISO9974-2 带弹性体密封结构

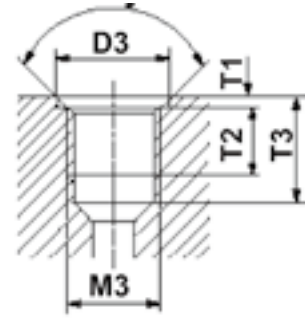

DIN3852-1/ ISO9974-1
与A, B和E型端部适配的螺纹孔形式X

系列	钢管外径O.D.	M1/M2	M3	D1	D2	T1	T2	T3
LL	4	M8x1	M8x1	12	-	1	8	13.5
LL	6	M10x1	M10x1	14	13.9	1	8	13.5
LL	8	M10x1	M10x1	14	13.9	1	8	13.5
L	6	M10x1	M10x1	14	13.9	1	8	13.5
L	8	M12x1.5	M12x1.5	17	16.9	1.5	12	18.5
L	10	M14x1.5	M14x1.5	19	18.9	1.5	14	18.5
L	12	M16x1.5	M16x1.5	21	21.9	1.5	12	18.5
L	15	M18x1.5	M18x1.5	23	23.9	2	12	18.5
L	18	M22x1.5	M22x1.5	27	26.9	2.5	14	20.5
L	22	M26x1.5	M26x1.5	31	31.9	2.5	16	22.5
L	28	M33x2	M33x2	39	39.9	2.5	18	26
L	35	M42x2	M42x2	49	49.9	2.5	20	28
L	42	M48x2	M48x2	55	54.9	2.5	22	30
S	6	M12x1.5	M12x1.5	17	16.9	1.5	12	18.5
S	8	M14x1.5	M14x1.5	19	18.9	1.5	12	18.5
S	10	M16x1.5	M16x1.5	21	21.9	1.5	12	18.5
S	12	M18x1.5	M18x1.5	23	23.9	2	12	18.5
S	14	M20x1.5	M20x1.5	25	25.9	2	14	20.5
S	16	M22x1.5	M22x1.5	27	26.9	2.5	14	20.5
S	20	M27x2	M27x2	32	31.9	2.5	16	24
S	25	M33x2	M33x2	39	39.9	2.5	18	26
S	30	M42x2	M42x2	49	49.9	2.5	20	28
S	38	M48x2	M48x2	55	54.9	2.5	22	30

b) 英制标准管螺纹螺栓端部和端口的螺纹符合DIN3852标准第12部分的形式B和DIN3852第11部分的形式E，而其端口螺纹则符合上述标准的形式X。

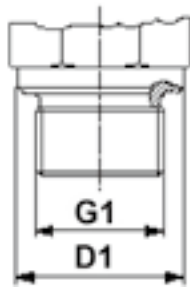

DIN3852-2 形式B
IS01179-4 硬密封结构

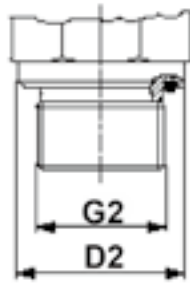

DIN3852-11 形式E
IS01179-1 带弹性体密封结构

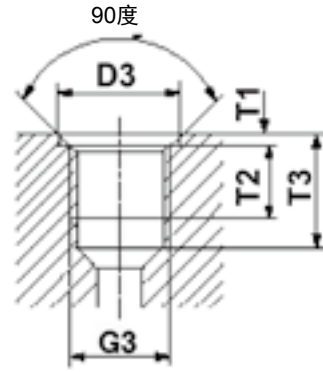

DIN3852-2 / IS09974-1
与A, B和E型适配的螺纹孔形式X

系列	钢管外径O.D.	G1/G2	G3	D1	D2	T1	T2	T3
LL	4	G1/8"A	G1/8"	14	13.9	1	8	13
LL	6	G1/8"A	G1/8"	14	13.9	1	8	13
LL	8	G1/8"A	G1/8"	14	13.9	1	8	13
L	6	G1/8"A	G1/8"	14	13.9	1	8	13
L	8	G1/4"A	G1/4"	18	18.9	1.5	12	18.5
L	10	G1/4"A	G1/4"	18	18.9	1.5	12	18.5
L	12	G3/8"A	G3/8"	22	21.9	2	12	18.5
L	15	G1/2"A	G1/2"	26	26.9	2.5	14	22
L	18	G1/2"A	G1/2"	26	26.9	2.5	14	22
L	22	G3/4"A	G3/4"	32	31.9	2.5	16	24
L	28	G1"A	G1"	39	39.9	2.5	18	27
L	35	G1.1/4"A	G1.1/4"	49	49.9	2.5	20	29
L	42	G1.1/2"A	G1.1/2"	55	54.9	2.5	22	31
S	6	G1/4"A	G1/4"	18	18.9	1.5	12	18.5
S	8	G1/4"A	G1/4"	18	18.9	1.5	12	18.5
S	10	G3/8"A	G3/8"	22	21.9	2	12	18.5
S	12	G3/8"A	G3/8"	22	21.9	2	12	18.5
S	14	G1/2"A	G1/2"	26	26.9	2.5	14	22
S	16	G1/2"A	G1/2"	26	26.9	2.5	14	22
S	20	G3/4"A	G3/4"	32	31.9	2.5	16	24
S	25	G1"A	G1"	39	39.9	2.5	18	27
S	30	G1.1/4"A	G1.1/4"	49	49.9	2.5	20	29
S	38	G1.1/2"A	G1.1/2"	55	54.9	2.5	22	31

c) 美国圆柱螺纹的螺栓端部和端口螺纹符合ISO 11926 - 2 / 3标准

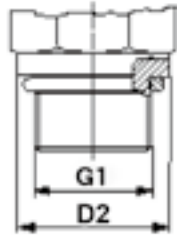

UN/UNF-2A O型密封圈
ISO 11926-2.3.

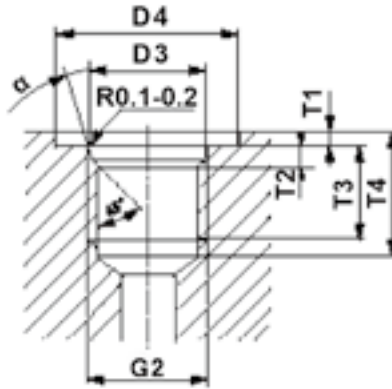

UN/UNF-2B O形圈密封
ISO 11926-1

系列	钢管外径O.D.	G1/G2	D2	D3	D4	T1	T2	T3	T4	α	O-Ring
L	6, 8, 10	7/16 "-20 UNF	16	12.4	21	1.6	2.4	11.5	14	12°	8.92 x 1.83
L	8	1/2 "-20 UNF	17	14	23	1.6	2.4	11.5	14	12°	10.52 x 1.83
L	6, 10, 12	9/16 "-18 UNF	17.6	15.6	25	1.6	2.5	12.7	15.5	12°	11.89 x 1.98
L	12, 15, 18	3/4 "-16 UNF	22.3	20.6	30	2.4	2.5	14.3	17.5	15°	16.36 x 2.2
L	12, 18, 22	7/8 "-14 UNF	25.5	23.9	34	2.4	2.5	16.7	20	15°	19.18 x 2.46
L	22, 28	1 "1/16-12 UN	31.9	29.2	41	2.4	3.3	19	23	15°	23.47 x 2.95
L	22, 28, 35	1 "5/16-12 UN	38.2	35.5	49	3.2	3.3	19	23	15°	29.74 x 2.95
L	35, 42	1 "5/8-12 UN	48	43.5	58	3.2	3.3	19	23	15°	37.47 x 3
L	42	1 "7/8-12 UN	55	49.8	65	3.2	3.3	19	23	15°	43.69 x 3
S	6, 8	7/16 "-20 UNF	16	12.4	21	1.6	2.4	11.5	14	15°	8.92 x 1.83
S	6	1/2 "-20 UNF	17	14	23	1.6	2.4	11.5	14	15°	10.52 x 1.83
S	10, 12	9/16 "-18 UNF	17.6	15.6	25	1.6	2.5	12.7	15.5	15°	11.89 x 1.98
S	12, 14	3/4 "-16 UNF	22.3	20.6	30	2.4	2.5	14.3	17.5	15°	16.36 x 2.2
S	16, 20	3/4 "-16 UNF	22.3	20.6	30	2.4	2.5	14.3	17.5	15°	16.36 x 2.2
S	16, 20	7/8 "-14 UNF	25.5	23.9	34	2.4	2.5	16.7	20	15°	19.18 x 2.46
S	20, 25	1 "1/16-12 UN	31.9	29.2	41	2.4	3.3	19	23	15°	23.47 x 2.95
S	25, 30	1 "5/16-12 UN	38.2	35.5	49	3.2	3.3	19	23	15°	29.74 x 2.95
S	30, 38	1 "5/8-12 UN	48	43.5	58	3.2	3.3	19	23	15°	37.47 x 3
S	38	1 "7/8-12 UN	55	49.8	65	3.2	3.3	19	23	15°	43.69 x 3

d) 美国标准锥管螺纹的端部和端口螺纹符合ANSI/ASME B1.20.1-1983标准

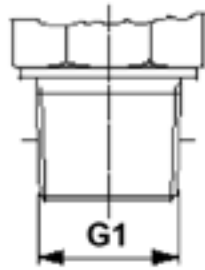

Ansi/ASME B1.20.1-1983
NPT端螺纹

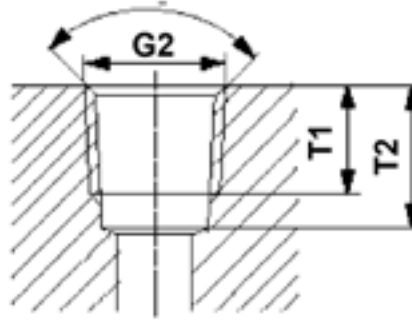

Ansi/ASME B1.20.1-1983
NPT螺纹孔

系列	钢管外径O.D.	G1/G2	T1	T2	公称通径DN
L	6	1/8"-27 NPT	6.9	11.6	04
L	8	1/4"-18 NPT	10	16.4	06
L	10	1/4"-18 NPT	10	16.4	08
L	12	3/8"-18 NPT	10.3	17.4	10
L	15	1/2"-14 NPT	13.6	22.6	13
L	18	1/2"-14 NPT	13.6	22.6	16
L	22	3/4"-14 NPT	14.1	23.1	20
L	28	1"-11.5 NPT	16.8	27.8	25
L	35	1.1/4"-11.5 NPT	17.3	28.3	32
L	42	1.1/2"-11.5 NPT	17.3	28.3	40
S	6	1/4"-18 NPT	10	16.4	03
S	8	1/4"-18 NPT	10	16.4	04
S	10	3/8"-18 NPT	10.3	17.4	06
S	12	3/8"-18 NPT	10.3	17.4	08
S	14	1/2"-14 NPT	13.6	22.6	10
S	16	1/2"-14 NPT	13.6	22.6	13
S	20	3/4"-14 NPT	14.1	23.1	16
S	25	1"-11.5 NPT	16.8	27.8	20
S	30	1.1/4"-11.5 NPT	17.3	28.3	25
S	38	1.1/2"-11.5 NPT	17.3	28.3	32

4. 卡套管接头的管端尺寸

HANSA-FLEX公司的液压管接头的管端是按照DIN3861标准的W形式的端口和DIN EN ISO 8434-1标准制造的标准化部件。

上述的端口也可以和公制的软管接头进行互换。

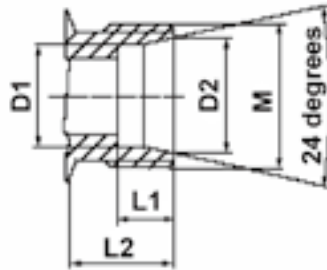

系列	钢管外径O.D.	公称压力PN in bar	M	L1	L2	D1	D2
LL	4	100	M8x1	4	8	4	5
LL	5	100	M10x1	5.5	8	5	6.5
LL	6	100	M10x1	5.5	8	6	7.5
LL	8	100	M12x1	5.5	9	8	9.5
L	6	315	M12x1.5	7	10	6	8.1
L	8	315	M14x1.5	7	10	8	10.1
L	10	315	M16x1.5	7	11	10	12.3
L	12	315	M18x1.5	7	11	12	14.3
L	15	315	M22x1.5	7	12	15	17.3
L	18	315	M26x1.5	7.5	12	18	20.3
L	22	160	M30x2	7.5	14	22	24.3
L	28	160	M36x2	7.5	14	28	30.3
L	35	160	M45x2	10.5	16	35.3	38
L	42	160	M52x2	11	16	42.3	45
S	6	630	M14x1.5	7	12	6	8.1
S	8	630	M16x1.5	7	12	8	10.1
S	10	630	M18x1.5	7.5	12	10	12.3
S	12	630	M20x1.5	7.5	12	12	14.3
S	14	630	M22x1.5	8	14	14	16.3
S	16	400	M24x1.5	8.5	14	16	18.3
S	20	400	M30x2	10.5	16	20	22.9
S	25	400	M36x2	12	18	25	27.9
S	30	400	M42x2	13.5	20	30	33
S	38	315	M52x2	16	22	38.3	41

5. 管接头的旋紧力矩

下列的旋紧力矩适用于带符合DIN 3852标准B和E型的螺栓端部(包括端口柱塞)的碳钢管接头,以及具有镀锌层鼓形管接头。这些力矩数据仅仅适用于管接头的材料和连接的部件(例如阀门,或者液压缸体)的材料完全相同的场合。

螺柱螺纹表(外螺纹)

螺纹形式	拧紧力矩		拧紧力矩
	(Nm)	油口接头 (Nm)	铰接接头 (Nm)
G1/8"	25	12	25
G1/4"	40	18	40
G3/8"	90	40	80
G1/2"	120	75	120
G3/4"	210	110	180
G1"	370	190	300
G 1.1/2"	500	240	300
G 1.1/2"	600	300	600
M10x1	25	12	25
M12x1.5	30	18	30
M14x1.5	50	20	50
M16x1.5	70	35	60
M18x1.5	90	50	70
M20x1.5	120	60	110
M22x1.5	130	70	130
M26x1.5	180	85	140
M27x2	220	100	150
M33x2	330	150	280
M42x2	500	260	280
M48x2	650	350	500

6. 钢管说明

HANSA-FLEX公司的产品范围也包括根据DIN EN10305-4标准制造的精密无缝钢管。这些钢管以冷拔无缝钢管,并且经过正态退火处理的状态交货。

无缝钢管具有镀锌表面保护层,或者具有深灰色的磷化和油面保护层。

7. 管接头的装配须知

7.1 装配前的管子准备工作

使用一把合适的锯子在管子上切割出90°角度。注意不要使用管子切割机进行切割,因为切割机会在管子的端部产生锥形的端口,而锥形端口会影响卡套的可靠固定。角度切割允许的偏差为0.5°。

小心地去除端口的毛刺。允许的倒角为0.2 x 45°。

清洁管子的端口,去除会影响管接头连接功能的固体粒子,例如金属碎片,污物。

在装配薄壁钢管和铜管,或铝管的时候,我们建议使用加强衬套。

直管管子的端部必须留出至少为二倍螺母高度的最小长度作为管子弯头。直的端口在圆周度和平直度方面的误差不能超过DIN2391标准规定的各个公差。

7.2 管接头卡套的预装配方式

a) 使用表面硬化处理的预装配模具;

b) 在接头体中进行直接预装配。注意,这种装配方法不适用不锈钢钢管的装配;

我们在此建议使用由淬火硬化的工具钢做成的装配模具进行管接头的装配。装配模具的材料强度足够抵御在管接头和管子之间产生的装配力而引起的变形。

7.2.1 使用表面硬化处理的装配模具进行装配

— 在装配工具的螺纹和锥体上涂上润滑油。

— 在管子上安装螺母和卡套。注意,卡套应该以正确的方向套入,确保卡套的刃边朝向管子安装端部。

- 用手旋紧螺母，直至感觉到装配力突然升高为止。
- 管端口必须紧紧压靠在装配模具内，否则卡套就不能对管子进行正确的切削。
- 再使用扳手把螺母旋转1 1/2转。在旋紧时，管子不可转动。

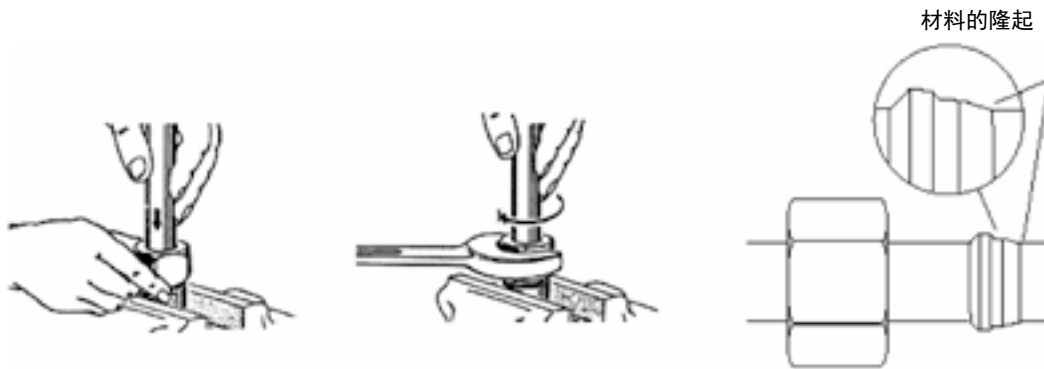

装配检查

- 松开旋转螺母，检查在卡套刃口前被切割的钢管材料可见隆起的位置，若隆起量不足，需加大力矩继续拧紧，并再次检查。
- 在任何情况下卡套只能转动，不可轴向移动。

7.2.2 在管接头本体上直接安装

- 对管接头本体的螺纹和锥体进行润滑。
- 在管子上装配旋转螺母和卡套，注意卡套必须以正确的方向套入，确保卡套的刃边朝向管子安装端部。
- 用手旋紧旋转螺母，直至拧不动为止。
- 管子端口必须紧紧压靠在接头本体内部的止挡上。否则卡套就不能对管子进行正确的切削。

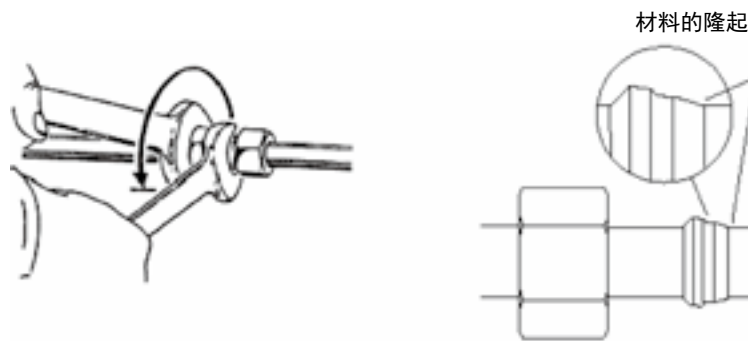

- 使用扳手继续旋紧螺母1 1/2转，同时用另一扳手夹持住管接头本体。

装配检查

- 松开旋转螺母，检查在卡套刃口前被切割的钢管材料可见隆起的位置，若隆起量不足，需加大力矩继续拧紧，并再次检查。
- 在任何情况下卡套只能转动，不可轴向移动。

7.3 最终安装

将已预装卡套的管端插入接头体内，紧紧顶住后用手拧紧螺母，然后使用开口扳手拧紧，至明显感觉阻力激增为止，再继续拧紧1/4圈。

8. 37°扩口管接头的装配

扩口管接头的装配有二种形式：

- 1) 使用一个24°的锥体，一个衬套，一个端口为W型的标准管接头（分别按照DIN2353和DIN3861标准）。
 - 使用一把合适的锯子在管子上切割出90°角度。注意不要使用管子切割机进行切割，因为切割机会在管子的端部产生不良的密封表面。
 - 小心地去除端口的毛刺。不能在管子的端口形成“尖锐”刃口。
 - 清洁管子的端口，去除会影响管接头的密封功能的固体粒子，例如金属碎片，污物。

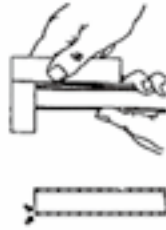

- 在管子上安装螺母和扩口衬套。注意，扩口衬套必须以正确的方向安装。
- 使用扩口机，或者其他合适的机器对管子端口进行扩口。

管子的扩口端口必须和管子保持同心度，端口应该保持清洁，表面光滑，以便取得最佳的密封效果。
- 然后将24°锥体按图示方向使管接头本体和扩口端连接，用手旋紧螺母，直至感觉到装配力突然激增为止。
- 最后装配时，使用扳手把螺母旋紧1/4圈到1/2圈。
- 重复安装须用与第一次安装时相同的力量。

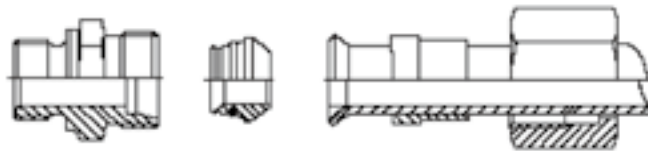

- 2) 使用SAE J514和ISO 8434-2标准的扩口管接头。

这些管接头是由管接头本体、扩口衬套和旋紧螺母组成，扩口管子被夹在管接头本体和扩口衬套之间，通过旋紧螺母使管子和管接头连接在一起。

按照上述的要求，切割下管子，并且对管子的端口进行机加工。在进行装配时，用手旋紧螺母，直至感觉到装配力突然激增为止，然后使用扳手将螺母再旋紧1/4至1/2圈，在此过程中应用另一扳手夹持住管接头本体。

重复安装时应用与第一次安装时相同的力量拧紧螺母。

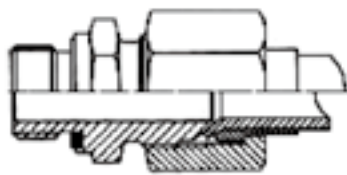

9. 焊接管接头的装配

- 以90°的切割角度切割管子，去除毛刺，根据DIN2559的要求打好焊接坡口。
- 在焊接管接头上安装螺母。
- 焊接管子和管接头。必须特别注意，在焊接前取出“O”形密封圈，并且清洁焊接处，必要时打磨焊接后应该去除可能留存的焊珠。
- 在管接头完全冷却后，安装“O”形密封圈。注意，千万不能扭曲“O”形密封圈。
- 为了便于安装，可以适当润滑管接头。
- 用手旋紧螺母，直至感觉到装配力突然激增为止。
- 再次把旋转螺母再旋紧1/4转。已带有焊接头的管子要平直地插入接头本体，勿弯扭以免产生应力。

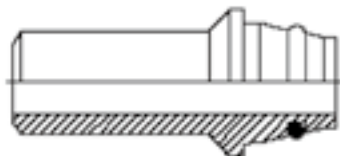

10. 螺纹表格

10.1 公制螺纹表格

公制螺纹	软管尺寸			外径	内径	管子外径				
	DN	英寸	规格			DIN 7631 60°	L 系列 24°	S 系列 24°	法标 24° (mm)	法标 24°
M12-1				12.00	11.00				6	
M12-1.5	5	1/8	2	12.00	10.50	4	6			
M14-1.5	5+6	1/8+1/4	2+4	14.00	12.50	6	8	6	8	
M16-1.5	6	1/4	4	16.00	14.50			8		
M16-1.5	8	5/16	5	16.00	14.50	8	10		10	
M18-1.5	6	1/4	4	18.00	16.50			10		
M18-1.5	10	3/8	6	18.00	16.50	10	12		12	
M20-1.5	8	5/16	5	20.00	18.50			12	14	13.25
M22-1.5	10	3/8	6	22.00	20.50			14		
M22-1.5	12	1/2	8	22.00	22.50	12	15		15	
M24-1.5	12	1/2	8	24.00	22.50			16	16	16.75
M26-1.5	16	5/8	10	26.00	24.50	16	18			
M27-1.5	16	5/8	10	27.00	25.50				18	
M30-1.5	20	3/4	12	30.00	28.50	20			22	21.25
M30-2	16	5/8	10	30.00	27.90			20		
M30-2	20	3/4	12	30.00	27.90		22			
M33-1.5	20	3/4	12	33.00	31.50				25	
M36-1.5	25	1	16	36.00	34.50				28	26.75
M36-2	20	3/4	12	36.00	33.90			25		
M36-2	25	1	16	36.00	33.90		28			
M38-1.5	25	1	16	38.00	36.50	25				
M39-1.5	25	1	16	39.00	37.50				30	
M42-1.5	25	1	16	42.00	40.50				32	
M42-2	25	1	16	42.00	39.90			30		
M45-1.5	32	1 1/4	20	45.00	43.00	32			35	
M45-2	32	1 1/4	20	45.00	42.90		35			
M48-1.5	32	1 1/4	20	48.00	46.50				38	M52-1.5
M52-1.5	40	1 1/2	24	52.00	50.50	40				
M52-2	32	1 1/4	20	52.00	49.90			38		
M52-2	40	1 1/2	24	52.00	49.90		42			
M54-2	40	1 1/2	24	54.00	51.90				45	
M58-2	40	1 1/2	24	58.00	55.90					48.25
M65-2	50	2	32	65.00	62.90	50				
M78-2	60			78.00	75.90	60				
M90-2	70			90.00	87.90	70				
M110-2	80			110.00	97.90	80				
M110-2	90			110.00	107.90	90				
M120-2	100	4	64	120.00	117.90	100				

10.2 英国标准管螺纹的螺纹表格

BSP螺纹	螺纹数 / 英寸	软管尺寸			外径	内径
		DN	英寸	规格		
G 1/8"	28	5	1/8	2	9.73	8.60
G 1/4"	19	6	1/4	4	13.16	11.50
G 3/8"	19	10	3/8	6	16.66	14.90
G 1/2"	14	12	1/2	8	20.96	18.60
G 5/8"	14	16	5/8	10	22.91	20.60
G 3/4"	14	20	3/4	12	26.44	24.10
G 1"	11	25	1	16	33.25	30.30
G 1.1/4"	11	32	1 1/4	20	41.91	38.90
G 1.1/2"	11	40	1 1/2	24	47.80	44.90
G 2"	11	50	2	32	59.62	56.70

10.3 美国标准锥管螺纹的螺纹表格

NPT螺纹	软管尺寸			外径	内径
	DN	英寸	规格		
1/8"-27	5	1/8	2	9.70	8.60
1/4"-18	6	1/4	4	13.10	11.30
3/8"-18	10	3/8	6	16.30	15.10
1/2"-14	12	1/2	8	20.20	18.60
3/4"-14	20	3/4	12	25.50	24.10
1"-11.5	25	1	16	32.20	30.20
1.1/4"-11.5	32	1 1/4	20	41.00	38.90
1.1/2"-11.5	40	1 1/2	24	47.00	44.90
2"-11.5	50	2	32	58.90	56.70

10.4 统一标准螺纹表格

UN 螺纹	软管尺寸			外径	内径	适用标准	UN 螺纹	软管尺寸			外径	内径	适用标准
	DN	英寸	规格					DN	英寸	规格			
5/16-24 UN	5	1/8	2	7.94	7.15	JIC	1 3/16-12 UN	20	3/4	14+12	30.10	27.50	JIC+ORS
3/8-24 UNF	5	3/16	3	9.52	8.60	JIC	1 5/16-12 UN	25	1	16	33.30	31.30	JIC
7/16-20 UNF	6	1/4	4	11.07	10.00	JIC+SAE	1 5/16-14 UNS	25	1	16	33.30	31.60	PTT
1/2-20 UNF	8	5/16	5	12.70	11.60	JIC+SAE	1 7/16-12	25	1	16	36.40	33.80	ORS
9/16-18 UNF	10	3/8	6+4	14.25	13.00	JIC+ORS	1 5/8-12 UN	32	1 1/4	20	41.22	39.20	JIC
5/8-18 UNF	10	3/8	6	15.85	14.70	SAE	1 5/8-14 UNS	32	1 1/4	20	41.22	39.50	PTT
11/16-16 UN	10	3/8	6	17.40	15.40	ORS	1 11/16-12 UN	32	1 1/4	20	42.80	40.20	ORS
3/4-16 UNF	12	1/2	8	19.00	17.60	JIC+SAE	1 7/8-12 UN	40	1 1/2	24	47.57	45.60	JIC
13/16-16 UN	12	1/2	8	20.50	18.60	ORS	1 7/8-14 UNS	40	1 1/2	24	47.57	45.90	PTT
7/8-14 UNF	16	5/8	10	22.17	20.50	JIC+SAE	2-14 UN	40	1 1/2	24	50.70	48.10	ORS
1-14 UNS	16	5/8	10	25.30	23.10	ORS	2 1/2-12 UN	50	2	32	63.45	61.50	JIC+PTT
1 1/16-12 UN	20	3/4	12	26.95	25.00	JIC	3-12 UN	60	2 1/2	40	76.20	74.30	JIC
1 1/16-14 UNS	20	3/4	12	26.95	25.30	SAE	3 1/2-12 UN	80	3	48	88.90	87.00	JIC

11. 如何订购接头 (型号说明):

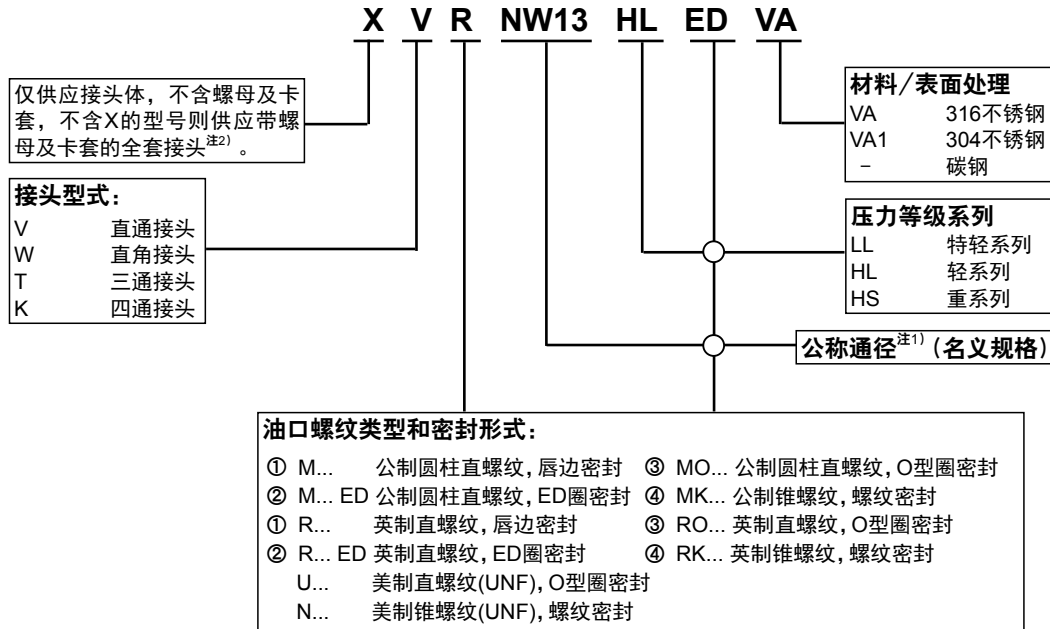

订货示例:

订货号	描述
XV M NW 13 HL 16 ED	端直通接头体(不含螺母及卡套), 15mm钢管外径, 油口端公制圆柱管螺纹M16x1.5, ED圈密封, 碳钢。
AOVR NW 10 S ED VA1	端直通接插件(活动螺母端), 可与14S卡套的管端相连, BSP标准外螺纹, ED圈密封, 304不锈钢
HVM NW 32 HS ED VA	单向阀(含螺母及卡套)液流方向油口至钢管, 38mm钢管外径, 油口端公制圆柱管螺纹, ED圈密封, 316不锈钢, 开启压力1bar

注1): 名义规格所对应的实际管径详见各型号列表所示;

注2): 部分旋转管接头的供货形式例外, 烦请参考各页图示和说明。

普通卡套

SRD

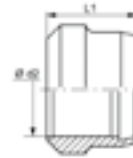

订货号	结构系列	Ød2 mm	管外径Ø mm	L1 mm
SRD 04 LL	LL	4	4	6.0
SRD 05 LL	LL	5	5	7.0
SRD 06 LL	LL	6	6	7.0
SRD 08 LL	LL	8	8	7.0
SRD 10 LL	LL	10	10	7.0
SRD 12 LL	LL	12	12	7.5
SRD 16 LL	LL	16	16	9.0
SRD 06	L / S	6	6	9.5
SRD 08	L / S	8	8	9.5
SRD 10	L / S	10	10	10.0
SRD 12	L / S	12	12	10.0
SRD 14	S	14	14	10.5
SRD 15	L	15	15	10.0
SRD 16	S	16	16	10.5
SRD 18	L	18	18	10.0
SRD 20	S	20	20	12.5
SRD 22	L	22	22	11.5
SRD 25	S	25	25	12.5
SRD 28	L	28	28	11.5
SRD 30	S	30	30	13.5
SRD 35	L	35	35	13.5
SRD 38	S	38	38	13.5
SRD 42	L	42	42	13.5
SRD 65	L	65	65	21.2

系列：LL=特轻系列 L=轻系列 S=重系列

带弹性密封体的卡套

SRDO V

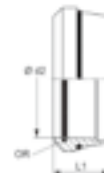

订货号	系列	Ød2 mm	管外径Ø mm	L1 mm	OR
SRDO 06 V	L / S	6	6	8.8	6 x 1
SRDO 08 V	L / S	8	8	8.8	8 x 1
SRDO 10 V	L / S	10	10	9.8	10 x 1
SRDO 12 V	L / S	12	12	9.8	12 x 1
SRDO 14 V	S	14	14	10.2	14 x 1
SRDO 15 V	L	15	15	10.2	15 x 1
SRDO 16 V	S	16	16	10.2	16 x 1
SRDO 18 V	L	18	18	10.2	18 x 1
SRDO 20 V	S	20	20	12.5	20 x 1
SRDO 22 V	L	22	22	11.5	22 x 1
SRDO 25 V	S	25	25	12.5	25 x 1
SRDO 28 V	L	28	28	11.5	28 x 1
SRDO 30 V	S	30	30	13.5	30 x 1
SRDO 35 V	L	35	35	13.5	35 x 1
SRDO 38 V	S	38	38	13.5	38 x 1
SRDO 42 V	L	42	42	13.5	42 x 1

系列：LL=特轻系列 L=轻系列 S=重系列

螺母

UEM

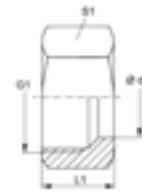

订货号	结构系列	Ød2 mm	G1	L1 mm	S1
UEM 04 LL	LL	4	M 8 x 1	11.5	10
UEM 05 LL	LL	5	M 10 x 1	12.0	12
UEM 06 LL	LL	6	M 10 x 1	12.0	12
UEM 08 LL	LL	8	M 12 x 1	12.5	14
UEM 10 LL	LL	10	M 14 x 1	13.5	17
UEM 12 LL	LL	12	M 16 x 1	13.5	19
UEM 16 LL	LL	16	M 22 x 1.5	17.5	27
UEM NW 04 L	L	6	M 12 x 1.5	15.0	14
UEM NW 06 L	L	8	M 14 x 1.5	15.0	17
UEM NW 08 L	L	10	M 16 x 1.5	16.0	19
UEM NW 10 L	L	12	M 18 x 1.5	16.0	22
UEM NW 13 L	L	15	M 22 x 1.5	17.5	27
UEM NW 16 L	L	18	M 26 x 1.5	18.5	32
UEM NW 16 L 27	L	18	M 27 x 2	18.0	32
UEM NW 20 L	L	22	M 30 x 2	20.5	36
UEM NW 25 L	L	28	M 36 x 2	21.5	41
UEM NW 32 L	L	35	M 45 x 2	24.5	50
UEM NW 40 L	L	42	M 52 x 2	24.5	60
UEM NW 03 S	S	6	M 14 x 1.5	17.0	17
UEM NW 04 S	S	8	M 16 x 1.5	17.0	19
UEM NW 06 S	S	10	M 18 x 1.5	18.0	22
UEM NW 08 S	S	12	M 20 x 1.5	18.0	24
UEM NW 10 S	S	14	M 22 x 1.5	21.0	27
UEM NW 13 S	S	16	M 24 x 1.5	21.0	30
UEM NW 16 S	S	20	M 30 x 2	24.5	36
UEM NW 20 S	S	25	M 36 x 2	27.5	46
UEM NW 25 S	S	30	M 42 x 2	29.5	50
UEM NW 32 S	S	38	M 52 x 2	33.0	60

系列: LL=特轻系列 L=轻系列 S=重系列
 产品型号说明: UEM VA: 不锈钢, UEM MG: 黄铜; G1=接口螺纹

扁螺母

KM

结构类型: 用于螺栓固紧

标准: DIN 80705 ISO 8434-1



订货号	G1	L1 mm	SW mm
KM 12	M 12 x 1.5	6	17
KM 14	M 14 x 1.5	6	19
KM 16	M 16 x 1.5	6	22
KM 18	M 18 x 1.5	6	24
KM 20	M 20 x 1.5	6	27
KM 22	M 22 x 1.5	7	30
KM 24	M 24 x 1.5	7	32
KM 26	M 26 x 1.5	8	36
KM 30	M 30 x 2	9	41
KM 36 - 1.5	M 36 x 1.5	9	46
KM 36	M 36 x 2	9	46
KM 42	M 42 x 2	9	50
KM 45	M 45 x 2	9	55
KM 52	M 52 x 2	10	65

产品型号说明: KM_VA: 不锈钢, KM_MG: 黄铜

卡套软密封

结构形式：用于卡套的软密封

原料：FPM (Viton)

提示：允许的工作温度(氟胶)：-25°C至+200°C



SRWD-VI



订货号	系列	Ød1 mm	Ød2 mm	E mm
SRWD 06 VI	L / S	6	9.1	7.3
SRWD 08 VI	L / S	8	8.0	7.3
SRWD 10 VI	L / S	10	13.3	7.3
SRWD 12 VI	L / S	12	15.3	7.0
SRWD 14 VI	S	14	18.8	7.2
SRWD 15 VI	L	15	19.0	7.2
SRWD 16 VI	S	16	20.8	7.5
SRWD 18 VI	L	18	22.8	7.7
SRWD 20 VI	S	20	25.8	9.3
SRWD 22 VI	L	22	26.3	7.9
SRWD 25 VI	S	25	31.5	8.9
SRWD 28 VI	L	28	32.3	8.0
SRWD 30 VI	S	30	37.3	8.2
SRWD 35 VI	L	35	41.3	8.0
SRWD 38 VI	S	38	46.0	8.2
SRWD 42 VI	L	42	48.3	8.2

系列：LL=特轻系列 L=轻系列 S=重系列

直通管接头

结构形式：直通

连接1-2：公制外螺纹

密封形式：24°内锥面密封

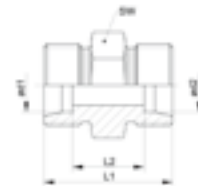

XV



订货号	系列	工作压力 bar	Ød1 mm	Ød2 mm	L1 mm	L2 mm	SW mm
XV 04 LL	LL	PN 100	4	4	20	12.0	9
XV 05 LL	LL	PN 100	5	5	20	9.0	11
XV 06 LL 04	LL	PN 100	6	4	20	10.5	11
XV 06 LL	LL	PN 100	6	6	20	9.0	11
XV 08 LL 04	LL	PN 100	8	4	22	12.5	12
XV 08 LL 06	LL	PN 100	8	6	22	11.0	12
XV 08 LL	LL	PN 100	8	8	23	12.0	12
XV 10 LL	LL	PN 100	10	10	23	12.0	14
XV 12 LL	LL	PN 100	12	12	23	11.0	17
XV NW 04 HL	L	PN 315	6	6	24	10.0	12
XV NW 06 HL 04	L	PN 315	8	6	25	11.0	14
XV NW 06 HL	L	PN 315	8	8	25	11.0	14
XV NW 08 HL 04	L	PN 315	10	6	26	12.0	17
XV NW 08 HL 06	L	PN 315	10	8	26	12.0	17
XV NW 08 HL	L	PN 315	10	10	27	13.0	17
XV NW 10 HL 04	L	PN 315	12	6	27	13.0	19
XV NW 10 HL 06	L	PN 315	12	8	27	13.0	19
XV NW 10 HL 08	L	PN 315	12	10	28	14.0	19
XV NW 10 HL	L	PN 315	12	12	28	14.0	19
XV NW 13 HL 04	L	PN 315	15	6	28	14.0	24
XV NW 13 HL 06	L	PN 315	15	8	28	14.0	24
XV NW 13 HL 08	L	PN 315	15	10	29	15.0	24
XV NW 13 HL 10	L	PN 315	15	12	29	15.0	24
XV NW 13 HL	L	PN 315	15	15	30	16.0	24
XV NW 16 HL 04	L	PN 315	18	6	29	14.5	27
XV NW 16 HL 06	L	PN 315	18	8	29	14.5	27
XV NW 16 HL 08	L	PN 315	18	10	30	15.5	27
XV NW 16 HL 10	L	PN 315	18	12	30	15.5	27
XV NW 16 HL 10 27	L	PN 315	18	12	32	17.5	27
XV NW 16 HL 13	L	PN 315	18	15	31	16.5	27
XV NW 16 HL	L	PN 315	18	18	31	16.0	27
XV NW 16 HL 27	L	PN 315	18	18	35	20.0	27
XV NW 20 HL 06	L	PN 160	22	8	31	16.5	32
XV NW 20 HL 08	L	PN 160	22	10	32	17.5	32

直通管接头

XV

结构形式：直通

连接1-2：公制外螺纹

密封形式：24°内锥面密封

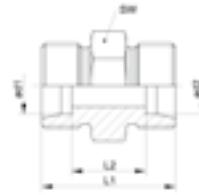

订货号	系列	工作压力 bar	Ød1 mm	Ød2 mm	L1 mm	L2 mm	SW mm
XV NW 20 HL 10	L	PN 160	22	12	32	17.5	32
XV NW 20 HL 13	L	PN 160	22	15	33	18.5	32
XV NW 20 HL 16	L	PN 160	22	18	33	18.0	32
XV NW 20 HL 16 27	L	PN 160	22	18	35	20.0	32
XV NW 20 HL	L	PN 160	22	22	35	20.0	32
XV NW 25 HL 06	L	PN 160	28	8	33	18.5	41
XV NW 25 HL 08	L	PN 160	28	10	34	19.5	41
XV NW 25 HL 10	L	PN 160	28	12	34	19.5	41
XV NW 25 HL 13	L	PN 160	28	15	35	20.5	41
XV NW 25 HL 16	L	PN 160	28	18	35	20.0	41
XV NW 25 HL 16 27	L	PN 160	28	18	37	22.0	41
XV NW 25 HL 20	L	PN 160	28	22	37	22.0	41
XV NW 25 HL	L	PN 160	28	28	36	21.0	41
XV NW 32 HL 20	L	PN 160	35	22	39	21.0	46
XV NW 32 HL 25	L	PN 160	35	28	39	21.0	46
XV NW 32 HL	L	PN 160	35	35	41	20.0	46
XV NW 40 HL 25	L	PN 160	42	28	41	22.5	55
XV NW 40 HL 32	L	PN 160	42	35	43	21.5	55
XV NW 40 HL	L	PN 160	42	42	66	21.0	55
XV NW 16 HL 13 HS	L / S	PN 315	18	16	33	17.0	27
XV NW 03 HS	S	PN 630	6	6	30	16.0	14
XV NW 04 HS 03	S	PN 630	8	6	32	18.0	17
XV NW 04 HS	S	PN 630	8	8	32	18.0	17
XV NW 06 HS 03	S	PN 630	10	6	32	17.5	19
XV NW 06 HS 04	S	PN 630	10	8	32	17.5	19
XV NW 06 HS	S	PN 630	10	10	32	17.0	19
XV NW 08 HS 03	S	PN 630	12	6	34	19.5	22
XV NW 08 HS 04	S	PN 630	12	8	34	19.5	22
XV NW 08 HS 06	S	PN 630	12	10	34	19.0	22
XV NW 08 HS	S	PN 630	12	12	34	19.0	22
XV NW 10 HS 03	S	PN 630	14	6	36	21.0	24
XV NW 10 HS 04	S	PN 630	14	8	36	21.0	24
XV NW 10 HS 06	S	PN 630	14	10	36	20.5	24
XV NW 10 HS 08	S	PN 630	14	12	36	20.5	24
XV NW 10 HS	S	PN 630	14	14	38	22.0	24
XV NW 13 HS 03	S	PN 400	16	6	36	20.5	27
XV NW 13 HS 04	S	PN 400	16	8	36	20.5	27
XV NW 13 HS 06	S	PN 400	16	10	36	20.0	27
XV NW 13 HS 08	S	PN 400	16	12	36	20.0	27
XV NW 13 HS 10	S	PN 400	16	14	38	21.5	27
XV NW 13 HS	S	PN 400	16	16	38	21.0	27
XV NW 16 HS 06	S	PN 400	20	10	40	22.0	32
XV NW 16 HS 08	S	PN 400	20	12	40	22.0	32
XV NW 16 HS 10	S	PN 400	20	14	42	23.5	32
XV NW 16 HS 13	S	PN 400	20	16	42	23.0	32
XV NW 16 HS	S	PN 400	20	20	44	23.0	32
XV NW 20 HS 13	S	PN 400	25	16	46	25.5	41
XV NW 20 HS 16	S	PN 400	25	20	48	25.5	41
XV NW 20 HS	S	PN 400	25	25	50	26.0	41
XV NW 25 HS 13	S	PN 400	30	16	48	26.0	46
XV NW 25 HS 16	S	PN 400	30	20	50	26.0	46
XV NW 25 HS 20	S	PN 400	30	25	52	26.5	46
XV NW 25 HS	S	PN 400	30	30	54	27.0	46
XV NW 32 HS 13	S	PN 315	38	16	53	28.5	55
XV NW 32 HS 20	S	PN 315	38	25	57	29.0	55
XV NW 32 HS 25	S	PN 315	38	30	59	29.5	55
XV NW 32 HS	S	PN 315	38	38	61	29.0	55
XV NW 13 HS 13 HL	S/L	PN 400	16	15	36	20.5	27
XV NW 16 HS 13 HL	S/L	PN 400	20	15	40	22.5	32
XV NW 16 HS 16 HL	S/L	PN 400	20	18	40	22.0	32
XV NW 20 HS 20 HL	S/L	PN 400	25	22	46	26.5	41

系列：LL=特轻系列 L=轻系列，也可提供通径4~12的超轻系列，工作压力为100bar

直角管接头

结构形式: 90°角

接口1+2: 公制外螺纹

密封形式: 24°内锥面密封

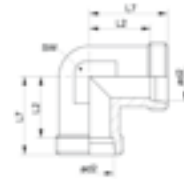

XW



订货号	系列	工作压力 bar	管外径Ø mm	Ød2 mm	L2 mm	L7 mm	SW mm
XW 04 LL	LL	PN 100	4	4	11.0	15	9
XW 05 LL	LL	PN 100	5	5	9.5	15	9
XW 06 LL	LL	PN 100	6	6	9.5	15	9
XW 08 LL	LL	PN 100	8	8	11.5	17	12
XW 10 LL	LL	PN 100	10	10	12.5	18	14
XW 12 LL	LL	PN 100	12	12	13.0	19	17
XW NW 04 HL	LL	PN 315	6	6	12.0	19	12
XW NW 06 HL	LL	PN 315	8	8	14.0	21	12
XW NW 08 HL	LL	PN 315	10	10	15.0	22	14
XW NW 10 HL	L	PN 315	12	12	17.0	24	17
XW NW 13 HL	L	PN 315	15	15	21.0	28	19
XW NW 16 HL	L	PN 315	18	18	23.5	31	24
XW NW 20 HL	L	PN 160	22	22	27.5	35	27
XW NW 25 HL	L	PN 160	28	28	30.5	38	36
XW NW 32 HL	L	PN 160	35	35	34.5	45	41
XW NW 40 HL	L	PN 160	42	42	40.0	51	50
XW NW 03 HS	S	PN 630	6	6	16.0	23	12
XW NW 04 HS	S	PN 630	8	8	17.0	24	14
XW NW 06 HS	S	PN 630	10	10	17.5	25	17
XW NW 08 HS	S	PN 630	12	12	21.5	29	17
XW NW 10 HS	S	PN 630	14	14	22.0	30	19
XW NW 13 HS	S	PN 400	16	16	24.5	33	24
XW NW 16 HS	S	PN 400	20	20	26.5	37	27
XW NW 20 HS	S	PN 400	25	25	30.0	42	36
XW NW 25 HS	S	PN 400	30	30	35.5	49	41
XW NW 32 HS	S	PN 315	38	38	41.0	57	50

系列: LL=特轻系列 L=轻系列 S=重系列, 也可提供通径4~12的超轻系列, 工作压力为100bar

三通管接头

结构形式: T形

连接1-3: 公制外螺纹

密封形式: 24°内锥面密封

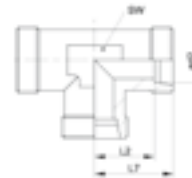

XT



订货号	系列	工作压力 bar	Ød2 mm	管外径Ø mm	G1-G3	L2 mm	L7 mm	SW mm
XT 04 LL	LL	PN 100	4	4	M 8 x 1	11.0	15	9
XT 05 LL	LL	PN 100	5	5	M 10 x 1	9.5	15	9
XT 06 LL	LL	PN 100	6	6	M 10 x 1	9.5	15	9
XT 08 LL	LL	PN 100	8	8	M 12 x 1	11.5	17	12
XT 10 LL	LL	PN 100	10	10	M 14 x 1	12.5	18	14
XT 12 LL	LL	PN 100	12	12	M 16 x 1	13.0	19	17
XT NW 04 HL	L	PN 315	6	6	M 12 x 1.5	12.0	19	12
XT NW 06 HL	L	PN 315	8	8	M 14 x 1.5	14.0	21	12
XT NW 08 HL	L	PN 315	10	10	M 16 x 1.5	15.0	22	14
XT NW 10 HL	L	PN 315	12	12	M 18 x 1.5	17.0	24	17
XT NW 13 HL	L	PN 315	15	15	M 22 x 1.5	21.0	28	19
XT NW 16 HL	L	PN 315	18	18	M 26 x 1.5	23.5	31	24
XT NW 20 HL	L	PN 160	22	22	M 30 x 2	27.5	35	27
XT NW 25 HL	L	PN 160	28	28	M 36 x 2	30.5	38	36
XT NW 32 HL	L	PN 160	35	35	M 45 x 2	34.5	45	41
XT NW 40 HL	L	PN 160	42	42	M 52 x 2	40.0	51	50
XT NW 03 HS	S	PN 630	6	6	M 14 x 1.5	16.0	23	12
XT NW 04 HS	S	PN 630	8	8	M 16 x 1.5	17.0	24	14
XT NW 06 HS	S	PN 630	10	10	M 18 x 1.5	17.5	25	17
XT NW 08 HS	S	PN 630	12	12	M 20 x 1.5	21.5	29	17
XT NW 10 HS	S	PN 630	14	14	M 22 x 1.5	22.0	30	19
XT NW 13 HS	S	PN 400	16	16	M 24 x 1.5	24.5	33	24
XT NW 16 HS	S	PN 400	20	20	M 30 x 2	26.5	37	27
XT NW 20 HS	S	PN 400	25	25	M 36 x 2	30.0	42	36
XT NW 25 HS	S	PN 400	30	30	M 42 x 2	35.5	49	41
XT NW 32 HS	S	PN 315	38	38	M 52 x 2	41.0	57	50

系列: LL=特轻系列 L=轻系列 S=重系列, 也可提供通径4~12的超轻系列, 工作压力为100bar; G1 - G3=接口螺纹

三通变径接头

结构形式: T形

连接1-3: 公制外螺纹

密封形式: 24°内锥面密封

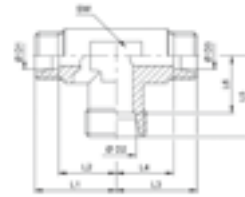

XRT



订货号	系列	工作压力 bar	D1 mm	D2 mm	D3 mm	L1 mm	L2 mm	L3 mm	L4 mm	L5 mm	L6 mm	SW mm
XRT 04 08 04 LL	LL	PN 100	4	8	4	17.0	13.0	17.0	13.0	17.0	11.5	12
XRT 06 04 06 LL	LL	PN 100	6	4	6	15.0	9.5	15.0	9.5	15.0	11.0	11
XRT NW 04 06 04 HL	L	PN 315	6	8	6	21.0	14.0	21.0	14.0	21.0	14.0	12
XRT NW 04 08 04 HL	L	PN 315	6	10	6	22.0	15.0	22.0	15.0	22.0	15.0	14
XRT NW 06 04 06 HL	L	PN 315	8	6	8	29.0	14.0	21.0	14.0	21.0	21.0	12
XRT NW 06 06 04 HL	L	PN 315	8	8	6	21.0	14.0	21.0	14.0	21.0	14.0	14
XRT NW 06 08 06 HL	L	PN 315	8	10	8	22.0	15.0	22.0	15.0	22.0	15.0	14
XRT NW 06 10 06 HL	L	PN 315	8	12	8	24.0	17.0	24.0	17.0	24.0	17.0	17
XRT NW 06 13 06 HL	L	PN 315	8	15	8	21.0	14.0	21.0	14.0	21.0	14.0	19
XRT NW 08 04 08 HL	L	PN 315	10	6	10	22.0	15.0	22.0	15.0	22.0	15.0	14
XRT NW 08 06 08 HL	L	PN 315	10	8	8	22.0	15.0	22.0	15.0	22.0	15.0	17
XRT NW 08 06 08 HL	L	PN 315	10	8	10	22.0	15.0	22.0	15.0	22.0	15.0	14
XRT NW 08 08 04 HL	L	PN 315	10	10	6	22.0	15.0	22.0	15.0	22.0	15.0	14
XRT NW 08 10 08 HL	L	PN 315	10	12	10	24.0	17.0	24.0	17.0	24.0	17.0	19
XRT NW 08 13 08 HL	L	PN 315	10	15	10	28.0	21.0	28.0	21.0	28.0	21.0	19
XRT NW 10 04 10 HL	L	PN 315	12	6	12	24.0	17.0	24.0	17.0	24.0	17.0	17
XRT NW 10 06 06 HL	L	PN 315	12	8	8	24.0	17.0	24.0	17.0	24.0	17.0	17
XRT NW 10 06 10 HL	L	PN 315	12	8	12	24.0	17.0	24.0	17.0	24.0	17.0	17
XRT NW 10 08 08 HL	L	PN 315	12	10	10	24.0	17.0	24.0	17.0	24.0	17.0	17
XRT NW 10 08 10 HL	L	PN 315	12	10	12	24.0	17.0	24.0	17.0	24.0	17.0	17
XRT NW 10 10 06 HL	L	PN 315	12	12	8	24.0	17.0	24.0	17.0	24.0	17.0	19
XRT NW 10 10 08 HL	L	PN 315	12	12	10	24.0	17.0	24.0	17.0	24.0	17.0	17
XRT NW 10 13 10 HL	L	PN 315	12	15	12	28.0	21.0	28.0	21.0	28.0	21.0	19
XRT NW 10 16 10 HL	L	PN 315	12	18	12	31.0	24.0	31.0	24.0	31.0	23.5	24
XRT NW 10 20 10 HL	L	PN 160	12	22	12	35.0	28.0	35.0	28.0	35.0	27.5	27
XRT NW 13 04 13 HL	L	PN 315	15	6	15	28.0	21.0	28.0	21.0	28.0	21.0	19
XRT NW 13 06 06 HL	L	PN 315	15	8	8	28.0	21.0	28.0	21.0	28.0	21.0	19
XRT NW 13 06 13 HL	L	PN 315	15	8	15	28.0	21.0	28.0	21.0	28.0	21.0	19
XRT NW 13 08 06 HL	L	PN 315	15	10	8	28.0	21.0	28.0	21.0	28.0	21.0	19
XRT NW 13 08 08 HL	L	PN 315	15	10	10	28.0	21.0	28.0	21.0	28.0	21.0	19
XRT NW 13 08 13 HL	L	PN 315	15	10	15	28.0	21.0	28.0	21.0	28.0	21.0	19
XRT NW 13 10 10 HL	L	PN 315	15	12	12	28.0	21.0	28.0	21.0	28.0	21.0	19
XRT NW 13 10 13 HL	L	PN 315	15	12	15	28.0	21.0	28.0	21.0	28.0	21.0	19
XRT NW 13 13 08 HL	L	PN 315	15	15	10	28.0	21.0	28.0	21.0	28.0	21.0	19
XRT NW 13 13 10 HL	L	PN 315	15	15	12	28.0	21.0	28.0	21.0	28.0	21.0	19
XRT NW 13 16 13 HL	L	PN 315	15	18	15	31.0	24.0	31.0	24.0	31.0	23.5	24
XRT NW 13 20 10 HL	L	PN 160	15	22	12	35.0	28.0	35.0	28.0	35.0	27.5	27
XRT NW 16 06 06 HL	L	PN 315	18	8	8	31.5	24.0	31.0	24.0	30.5	23.5	24
XRT NW 16 06 16 HL	L	PN 315	18	8	18	31.0	23.5	31.0	23.5	31.0	24.0	24
XRT NW 16 08 08 HL	L	PN 315	18	10	10	31.0	23.5	31.0	24.0	31.0	24.0	24
XRT NW 16 08 16 HL	L	PN 315	18	10	18	31.0	23.5	31.0	23.5	31.0	24.0	24
XRT NW 16 10 10 HL	L	PN 315	18	12	12	31.0	23.5	31.0	24.0	31.0	24.0	24
XRT NW 16 10 16 HL	L	PN 315	18	12	18	31.0	23.5	31.0	23.5	31.0	24.0	24
XRT NW 16 13 16 HL	L	PN 315	18	15	18	31.0	23.5	31.0	23.5	31.0	24.0	24
XRT NW 16 16 06 HL	L	PN 315	18	18	8	31.0	23.5	30.5	23.5	31.0	23.5	24
XRT NW 16 16 08 HL	L	PN 315	18	18	10	31.0	23.5	31.0	24.0	31.0	23.5	24
XRT NW 16 16 10 HL	L	PN 315	18	18	12	31.0	23.5	30.5	23.5	31.5	24.0	24
XRT NW 20 08 20 HL	L	PN 160	22	10	22	35.0	27.5	35.0	27.5	35.0	28.0	27
XRT NW 20 10 20 HL	L	PN 160	22	12	22	35.0	27.5	35.0	27.5	35.0	28.0	27
XRT NW 20 13 13 HL	L	PN 160	22	15	15	35.0	27.5	35.0	28.0	35.0	28.0	27
XRT NW 20 13 20 HL	L	PN 160	22	15	22	35.0	27.5	35.0	27.5	35.0	28.0	27
XRT NW 20 16 16 HL	L	PN 160	22	18	18	35.0	27.5	35.0	27.5	35.0	27.5	27
XRT NW 20 16 20 HL	L	PN 160	22	18	22	35.0	27.5	35.0	27.5	35.0	27.5	27
XRT NW 20 20 16 HL	L	PN 160	22	22	18	35.0	27.5	35.0	27.5	35.0	27.5	27
XRT NW 20 25 20 HL	L	PN 160	22	28	22	38.0	30.5	38.0	30.5	38.0	30.5	36
XRT NW 25 08 25 HL	L	PN 160	28	10	28	38.0	30.5	38.0	30.5	38.0	31.0	36
XRT NW 25 10 25 HL	L	PN 160	28	12	28	38.0	30.5	38.0	30.5	38.0	31.0	36
XRT NW 25 13 25 HL	L	PN 160	28	15	28	38.0	30.5	38.0	30.5	38.0	31.0	36

三通变径接头

结构形式: T形
 连接1-3: 公制外螺纹
 密封形式: 24°内锥面密封

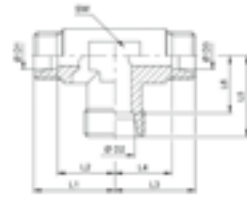

XRT



订货号	系列	工作压力 bar	D1 mm	D2 mm	D3 mm	L1 mm	L2 mm	L3 mm	L4 mm	L5 mm	L6 mm	SW mm
XRT NW 25 16 25 HL	L	PN 160	28	18	28	38.0	30.5	38.0	30.5	38.0	30.5	36
XRT NW 25 20 20 HL	L	PN 160	28	22	22	38.0	30.5	38.0	30.5	38.0	30.5	36
XRT NW 25 20 25 HL	L	PN 160	28	22	28	38.0	30.5	38.0	30.5	38.0	30.5	36
XRT NW 25 25 20 HL	L	PN 160	28	28	22	38.0	30.5	38.0	30.5	38.0	30.5	36
XRT NW 32 20 32 HL	L	PN 160	35	22	35	45.0	34.5	45.0	34.5	45.0	37.5	41
XRT NW 32 25 25 HL	L	PN 160	35	28	28	45.0	34.5	45.0	37.5	45.0	37.5	41
XRT NW 32 25 32 HL	L	PN 160	35	28	35	45.0	34.5	45.0	34.5	45.0	37.5	41
XRT NW 16 HL 16 HS	L / S	PN 315	20	18	20	37.0	26.5	37.0	26.5	37.0	29.5	27
XRT NW 04 03 04 HS	S	PN 630	8	6	8	20.0	13.0	19.0	12.0	20.0	13.0	12
XRT NW 06 03 06 HS	S	PN 630	10	6	10	25.0	17.5	25.0	17.5	25.0	18.0	17
XRT NW 08 03 08 HS	S	PN 630	12	6	12	24.5	17.0	24.5	17.0	24.0	17.0	17
XRT NW 08 04 04 HS	S	PN 630	12	8	8	29.0	21.5	29.0	22.0	29.0	22.0	17
XRT NW 08 04 08 HS	S	PN 630	12	8	12	29.0	21.5	29.0	21.5	29.0	22.0	17
XRT NW 08 06 08 HS	S	PN 630	12	10	12	29.0	21.5	29.0	21.5	29.0	21.5	17
XRT NW 08 13 08 HS	S	PN 630	12	16	12	33.0	25.5	33.0	25.5	33.0	24.5	24
XRT NW 10 06 10 HS	S	PN 630	14	10	14	30.0	22.0	30.0	22.0	30.0	22.5	19
XRT NW 13 03 13 HS	S	PN 400	16	68	16	33.0	24.5	33.0	24.5	33.0	26.0	24
XRT NW 13 04 13 HS	S	PN 400	16	10	16	33.0	24.5	33.0	24.5	33.0	26.0	24
XRT NW 13 06 13 HS	S	PN 400	16	12	16	33.0	24.5	33.0	24.5	33.0	25.5	24
XRT NW 13 08 13 HS	S	PN 400	16	20	16	33.0	24.5	33.0	24.5	33.0	25.5	24
XRT NW 13 16 13 HS	S	PN 400	16	10	16	37.0	28.5	37.0	28.5	37.0	26.5	27
XRT NW 16 06 16 HS	S	PN 400	20	12	20	37.0	26.5	37.0	26.5	37.0	29.5	27
XRT NW 16 08 16 HS	S	PN 400	20	14	20	37.0	26.5	37.0	26.5	37.0	29.5	27
XRT NW 16 10 16 HS	S	PN 400	20	16	20	37.0	26.5	37.0	26.5	37.5	29.5	27
XRT NW 16 13 16 HS	S	PN 400	20	20	20	37.0	26.5	37.0	26.5	37.0	28.5	27
XRT NW 16 16 20 HS	S	PN 400	20	25	25	39.0	28.5	40.5	28.5	37.0	28.5	36
XRT NW 16 20 16 HS	S	PN 400	20	16	20	42.0	31.5	42.0	31.5	42.0	30.0	36
XRT NW 20 13 20 HS	S	PN 400	25	20	25	42.0	30.0	42.0	30.0	42.0	33.5	36
XRT NW 20 16 20 HS	S	PN 400	25	30	25	42.0	30.0	42.0	30.0	42.0	31.5	36
XRT NW 20 25 20 HS	S	PN 400	25	16	25	49.0	37.0	49.0	37.0	49.0	35.5	41
XRT NW 25 13 25 HS	S	PN 400	30	20	30	49.0	35.5	49.0	35.5	49.0	40.5	41
XRT NW 25 16 25 HS	S	PN 400	30	25	30	49.0	35.5	49.0	35.5	49.0	38.5	41
XRT NW 25 20 25 HS	S	PN 400	30	30	25	49.0	35.5	49.0	35.5	49.0	37.0	41

系列: LL=特轻系列 L=轻系列 S=重系列

四通管接头

XK

结构形式：四通
 连接1-4：公制外螺纹
 密封形式：24°内锥面密封

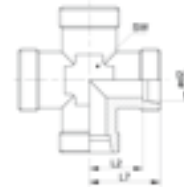

订货号	系列	工作压力 bar	Ød2 mm	管外径Ø mm	L2 mm	L7 mm	SW mm
XK 04 LL	LL	PN 100	4	4	11.0	15.0	9
XK 05 LL	LL	PN 100	5	5	9.5	15.0	9
XK 06 LL	LL	PN 100	6	6	9.5	15.0	9
XK 08 LL	LL	PN 100	8	8	11.5	17.0	12
XK NW 04 HL	L	PN 315	6	6	12.0	19.0	12
XK NW 06 HL	L	PN 315	8	8	14.0	21.0	12
XK NW 08 HL	L	PN 315	10	10	15.0	22.0	14
XK NW 10 HL	L	PN 315	12	12	17.0	24.0	17
XK NW 13 HL	L	PN 315	15	15	21.0	28.0	19
XK NW 16 HL	L	PN 315	18	18	23.5	31.0	24
XK NW 20 HL	L	PN 160	22	22	27.5	35.0	27
XK NW 25 HL	L	PN 160	28	28	30.5	38.0	36
XK NW 32 HL	L	PN 160	35	35	34.5	45.0	41
XK NW 40 HL	L	PN 160	42	42	40.0	51.0	50
XK NW 03 HS	S	PN 630	6	6	16.0	23.0	12
XK NW 04 HS	S	PN 630	8	8	17.0	24.0	14
XK NW 06 HS	S	PN 630	10	10	17.5	25.0	17
XK NW 08 HS	S	PN 630	12	12	21.5	29.0	17
XK NW 10 HS	S	PN 630	14	14	22.0	30.0	19
XK NW 13 HS	S	PN 400	16	16	24.5	33.0	24
XK NW 16 HS	S	PN 400	20	20	26.5	37.0	27
XK NW 20 HS	S	PN 400	25	25	30.0	42.0	36
XK NW 25 HS	S	PN 400	30	30	35.5	49.0	41
XK NW 32 HS	S	PN 315	38	38	41.0	57.0	50

系列：LL=特轻系列 L=轻系列 S=重系列，也可提供通径4~8的超轻系列，工作压力为100bar

端直通管接头（英制锥管螺纹）

XVRK

结构形式：端直通
 连接1：BSPT标准外螺纹
 密封形式：螺纹密封
 连接2：公制外螺纹
 密封形式：24°内锥面密封

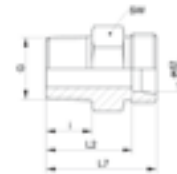

订货号	系列	工作压力 bar	Ød2 mm	管外径Ø mm	G	i mm	L2 mm	L7 mm	SW mm
XVR 04 LL	LL	PN 100	4	4	R 1/8" K	8.0	16.0	20.0	11
XVR 05 LL	LL	PN 100	5	5	R 1/8" K	8.0	14.5	20.0	11
XVR 06 LL	LL	PN 100	6	6	R 1/8" K	8.0	14.5	20.0	11
XVR 06 LL 1/4	LL	PN 100	6	6	R 1/4" K	12.0	14.5	20.0	12
XVR 08 LL	LL	PN 100	8	8	R 1/8" K	8.0	16.5	22.0	12
XVR 08 LL 1/4	LL	PN 100	8	8	R 1/4" K	12.0	20.5	26.0	14
XVR 10 LL	LL	PN 100	10	10	R 1/4" K	12.0	20.5	26.0	14
XVR 12 LL	LL	PN 100	12	12	R 1/4" K	12.0	20.0	26.0	17
XVR 12 LL 3/8	LL	PN 100	12	12	R 3/8" K	12.0	20.0	26.0	17
XVRK NW 04 HL	L	PN 315	6	6	R 1/8" K	10.5	17.5	24.5	12
XVRK NW 04 HL 1/4	L	PN 315	6	6	R 1/4" K	14.0	22.0	29.0	17
XVRK NW 06 HL 1/8	L	PN 315	8	8	R 1/8" K	10.5	18.5	25.5	14
XVRK NW 06 HL	L	PN 315	8	8	R 1/4" K	14.0	22.0	29.0	17
XVRK NW 06 HL 3/8	L	PN 315	8	8	R 3/8" K	14.5	22.5	30.5	19
XVRK NW 06 HL 1/2	L	PN 315	8	8	R 1/2" K	18.5	27.5	34.5	22
XVRK NW 08 HL 1/8	L	PN 315	10	10	R 1/8" K	10.5	19.5	26.5	17
XVRK NW 08 HL	L	PN 315	10	10	R 1/4" K	14.0	23.0	30.0	17
XVRK NW 08 HL 3/8	L	PN 315	10	10	R 3/8" K	14.5	24.5	31.5	19
XVRK NW 08 HL 1/2	L	PN 315	10	10	R 1/2" K	18.5	28.5	35.5	22
XVRK NW 10 HL 1/4	L	PN 315	12	12	R 1/4" K	14.0	24.0	31.0	19
XVRK NW 10 HL	L	PN 315	12	12	R 3/8" K	14.5	24.5	31.5	19
XVRK NW 10 HL 1/2	L	PN 315	12	12	R 1/2" K	18.5	28.5	35.5	24
XVRK NW 13 HL 3/8	L	PN 315	15	15	R 3/8" K	14.5	25.5	24.0	33
XVRK NW 13 HL	L	PN 315	15	15	R 1/2" K	18.5	29.5	36.5	24

端直通管接头 (英制锥管螺纹)

XVRK

结构形式: 端直通

连接1: BSPT标准外螺纹

密封形式: 螺纹密封

连接2: 公制外螺纹

密封形式: 24°内锥面密封



订货号	系列	工作压力 bar	Ød2 mm	管外径Ø mm	G	i mm	L2 mm	L7 mm	SW mm
XVRK NW 16 HL 3/8	L	PN 315	18	18	R 3/8" K	14.5	26.0	33.5	27
XVRK NW 16 HL	L	PN 315	18	18	R 1/2" K	18.5	30.0	37.5	27
XVRK NW 16 HL 3/4	L	PN 160	18	18	R 3/4" K	20.0	31.5	39.0	32
XVRK NW 20 HL 1/2	L	PN 160	22	22	R 1/2" K	18.5	32.0	39.5	32
XVRK NW 20 HL	L	PN 160	22	22	R 3/4" K	20.0	33.5	41.0	32
XVRK NW 25 HL	L	PN 160	28	28	R 1" K	24.0	38.5	46.0	41
XVRK NW 32 HL 1	L	PN 160	35	35	R 1" K	24.0	40.5	51.0	46
XVRK NW 32 HL	L	PN 160	35	35	R 1.1/4" K	26.0	42.5	53.0	46
XVRK NW 40 HL	L	PN 160	42	42	R 1.1/2" K	27.0	43.0	54.0	55
XVRK NW 03 HS	S	PN 400	6	6	R 1/4" K	14.0	27.0	34.0	17
XVRK NW 04 HS	S	PN 400	8	8	R 1/4" K	14.0	27.0	34.0	17
XVRK NW 06 HS 1/4	S	PN 400	10	10	R 1/4" K	14.0	26.5	34.0	19
XVRK NW 06 HS	S	PN 400	10	10	R 3/8" K	14.5	27.0	34.5	19
XVRK NW 08 HS 1/4	S	PN 400	12	12	R 1/4" K	14.0	28.5	36.0	22
XVRK NW 08 HS	S	PN 400	12	12	R 3/8" K	14.5	29.0	36.5	22
XVRK NW 08 HS 1/2	S	PN 400	12	12	R 1/2" K	18.5	33.0	40.5	22
XVRK NW 10 HS 3/8	S	PN 400	14	14	R 3/8" K	14.5	30.5	38.5	24
XVRK NW 10 HS	S	PN 400	14	14	R 1/2" K	18.5	34.5	42.5	24
XVRK NW 13 HS 3/8	S	PN 400	16	16	R 3/8" K	14.5	30.0	38.5	27
XVRK NW 13 HS	S	PN 400	16	16	R 1/2" K	18.5	34.0	42.5	27
XVRK NW 16 HS	S	PN 400	20	20	R 3/4" K	20.0	37.5	48.0	32
XVRK NW 20 HS	S	PN 400	25	25	R 1" K	24.0	43.0	55.0	41
XVRK NW 25 HS 1	S	PN 400	30	30	R 1" K	24.0	43.5	57.0	46
XVRK NW 25 HS	S	PN 400	30	30	R 1.1/4" K	26.0	45.5	59.0	46
XVRK NW 32 HS	S	PN 315	38	38	R 1.1/2" K	27.0	49.0	65.0	55

系列: LL=特轻系列 L=轻系列 S=重系列; G=接口螺纹

端直通管接头 (英制圆柱管螺纹)

XVR

结构形式: 端直通

连接1: BSP标准外螺纹

密封形式: B型

连接2: 公制外螺纹

密封形式: 24°内锥面密封

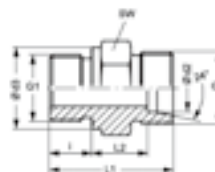

订货号	系列	工作压力 bar	Ød2 mm	G1	G2	管外径Ø mm	Ød3 mm	i mm	L1 mm	L2 mm	SW mm
XVR NW 04 HL	L	PN 315	6	G 1/8" -28	M 12 x 1.5	6	14	8	23.5	8.5	14
XVR NW 04 HL 1/4	L	PN 315	6	G 1/4" -19	M 12 x 1.5	6	18	12	29	10.0	19
XVR NW 04 HL 3/8	L	PN 315	6	G 3/8" -19	M 12 x 1.5	6	22	12	30.5	11.5	22
XVR NW 04 HL 1/2	L	PN 315	6	G 1/2" -14	M 12 x 1.5	6	26	14	33	12	27
XVR NW 06 HL 1/8	L	PN 315	8	G 1/8" -28	M 14 x 1.5	8	14	8	24.0	9	14
XVR NW 06 HL	L	PN 315	8	G 1/4" -19	M 14 x 1.5	8	18	12	29	10.0	19
XVR NW 06 HL 3/8	L	PN 315	8	G 3/8" -19	M 14 x 1.5	8	22	12	30.5	11.5	22
XVR NW 06 HL 1/2	L	PN 315	8	G 1/2" -14	M 14 x 1.5	8	26	14	33	12	27
XVR NW 08 HL 1/8	L	PN 315	10	G 1/8" -28	M 16 x 1.5	10	14	8	25.5	10.5	17
XVR NW 08 HL	L	PN 315	10	G 1/4" -19	M 16 x 1.5	10	18	12	30	11.0	19
XVR NW 08 HL 3/8	L	PN 315	10	G 3/8" -19	M 16 x 1.5	10	22	12	31.5	12.5	22
XVR NW 08 HL 1/2	L	PN 315	10	G 1/2" -14	M 16 x 1.5	10	26	14	34	13.0	27
XVR NW 10 HL 1/8	L	PN 315	12	G 1/8" -28	M 18 x 1.5	12	14	8	26.5	11.5	19
XVR NW 10 HL 1/4	L	PN 315	12	G 1/4" -19	M 18 x 1.5	12	18	12	31	12.0	19
XVR NW 10 HL	L	PN 315	12	G 3/8" -19	M 18 x 1.5	12	22	12	31.5	12.5	22
XVR NW 10 HL 1/2	L	PN 315	12	G 1/2" -14	M 18 x 1.5	12	26	14	34	13.0	27
XVR NW 10 HL 3/4	L	PN 315	12	G 3/4" -14	M 18 x 1.5	12	32	16	37	14.0	32
XVR NW 13 HL 1/4	L	PN 315	15	G 1/4" -19	M 22 x 1.5	15	18	12	32	13.0	24
XVR NW 13 HL 3/8	L	PN 250	15	G 3/8" -19	M 22 x 1.5	15	22	12	33.0	14.0	24

端直通管接头 (英制圆柱管螺纹)

XVR

结构形式: 端直通

连接1: BSP标准外螺纹

密封形式: B型

连接2: 公制外螺纹

密封形式: 24°内锥面密封

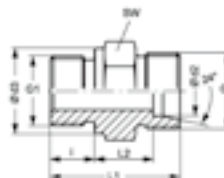

订货号	系列	工作压力 bar	Ød2 mm	G1	G2	管外径Ø mm	Ød3 mm	i mm	L1 mm	L2 mm	SW mm
XVR NW 13 HL	L	PN 250	15	G 1/2" -14	M 22 x 1.5	15	26	14	35	14.0	27
XVR NW 13 HL 3/4	L	PN 250	15	G 3/4" -14	M 22 x 1.5	15	32	16	38	15.0	32
XVR NW 13 HL 1	L	PN 250	15	G 1" -11	M 22 x 1.5	15	39	18	42.5	17.5	41
XVR NW 16 HL 3/8	L	PN 250	18	G 3/8" -19	M 26 x 1.5	18	22	12	33.5	14.0	27
XVR NW 16 HL	L	PN 250	18	G 1/2" -14	M 26 x 1.5	18	26	14	36	14.5	27
XVR NW 16 HL 3/4	L	PN 250	18	G 3/4" -14	M 26 x 1.5	18	32	16	38	14.5	32
XVR NW 16 HL 1	L	PN 250	18	G 1" -11	M 26 x 1.5	18	39	18	40.5	15.0	41
XVR NW 20 HL 1/2	L	PN 160	22	G 1/2" -14	M 30 x 2	22	26	14	38	16.5	32
XVR NW 20 HL	L	PN 160	22	G 3/4" -14	M 30 x 2	22	32	16	40	16.5	32
XVR NW 20 HL 1	L	PN 160	22	G 1" -11	M 30 x 2	22	39	18	43	17.5	41
XVR NW 25 HL 1/2	L	PN 160	28	G 1/2" -14	M 36 x 2	28	26	14	40	18.5	41
XVR NW 25 HL 3/4	L	PN 160	28	G 3/4" -14	M 36 x 2	28	32	16	41	17.5	41
XVR NW 25 HL	L	PN 160	28	G 1" -11	M 36 x 2	28	39	18	43	17.5	41
XVR NW 25 HL 1 1/4	L	PN 160	28	G 1.1/4" -11	M 36 x 2	28	49	20	46	18.3	50
XVR NW 32 HL 3/4	L	PN 160	35	G 3/4" -14	M 45 x 2	35	32	16	45	18.5	46
XVR NW 32 HL 1	L	PN 160	35	G 1" -11	M 45 x 2	35	39	18	47	18.5	46
XVR NW 32 HL	L	PN 160	35	G 1.1/4" -11	M 45 x 2	35	49	20	48	17.5	50
XVR NW 32 HL 1 1/2	L	PN 160	35	G 1.1/2" -11	M 45 x 2	35	55	22	51	18.5	55
XVR NW 40 HL 1 1/4	L	PN 160	42	G 1.1/4" -11	M 52 x 2	42	49	20	50	19.0	55
XVR NW 40 HL	L	PN 160	42	G 1.1/2" -11	M 52 x 2	42	55	22	52	19.0	55
XVR NW 03 HS 1/8	S	PN 400	6	G 1/8" -28	M 14 x 1.5	6	14	8	27.5	12.5	14
XVR NW 03 HS	S	PN 400	6	G 1/4" -19	M 14 x 1.5	6	18	12	32	13.0	19
XVR NW 03 HS 3/8	S	PN 400	6	G 3/8" -19	M 14 x 1.5	6	22	12	32.5	13.5	22
XVR NW 03 HS 1/2	S	PN 400	6	G 1/2" -14	M 14 x 1.5	6	26	14	35	14.0	27
XVR NW 04 HS	S	PN 400	8	G 1/4" -19	M 16 x 1.5	8	18	12	34	15.0	19
XVR NW 04 HS 3/8	S	PN 400	8	G 3/8" -19	M 16 x 1.5	8	22	12	34.5	15.5	22
XVR NW 04 HS 1/2	S	PN 400	8	G 1/2" -14	M 16 x 1.5	8	26	14	37	16.0	27
XVR NW 06 HS 1/4	S	PN 400	10	G 1/4" -19	M 18 x 1.5	10	18	12	34	14.5	19
XVR NW 06 HS	S	PN 400	10	G 3/8" -19	M 18 x 1.5	10	22	12	34.5	15.0	22
XVR NW 06 HS 1/2	S	PN 400	10	G 1/2" -14	M 18 x 1.5	10	26	14	39	17.5	27
XVR NW 08 HS 1/4	S	PN 400	12	G 1/4" -19	M 20 x 1.5	12	18	12	36	16.5	22
XVR NW 08 HS	S	PN 400	12	G 3/8" -19	M 20 x 1.5	12	22	12	36.5	17.0	22
XVR NW 08 HS 1/2	S	PN 400	12	G 1/2" -14	M 20 x 1.5	12	26	14	39	17.5	27
XVR NW 08 HS 3/4	S	PN 400	12	G 3/4" -14	M 20 x 1.5	12	32	16	41	17.5	32
XVR NW 10 HS 3/8	S	PN 400	14	G 3/8" -19	M 22 x 1.5	14	22	12	38.5	18.5	27
XVR NW 10 HS	S	PN 400	14	G 1/2" -14	M 22 x 1.5	14	26	14	41	19.0	27
XVR NW 10 HS 3/4	S	PN 400	14	G 3/4" -14	M 22 x 1.5	14	32	16	43	19.0	32
XVR NW 13 HS 1/4	S	PN 400	16	G 1/4" -19	M 24 x 1.5	16	22	12	38	18.5	27
XVR NW 13 HS 3/8	S	PN 400	16	G 3/8" -19	M 24 x 1.5	16	22	12	39	18.5	27
XVR NW 13 HS	S	PN 400	16	G 1/2" -14	M 24 x 1.5	16	27	14	41	18.5	27
XVR NW 13 HS 3/4	S	PN 400	16	G 3/4" -14	M 24 x 1.5	16	32	16	45	20.5	32
XVR NW 16 HS 1/2	S	PN 400	20	G 1/2" -14	M 30 x 2	20	26	14	45	20.5	32
XVR NW 16 HS	S	PN 400	20	G 3/4" -14	M 30 x 2	20	39	18	47	20.5	32
XVR NW 16 HS 1	S	PN 250	20	G 1" -11	M 36 x 2	20	39	18	50	21.5	41
XVR NW 20 HS 1/2	S	PN 250	25	G 1/2" -14	M 36 x 2	25	26	14	49	23.0	41
XVR NW 20 HS 3/4	S	PN 250	25	G 3/4" -14	M 36 x 2	25	32	16	51	23.5	41
XVR NW 20 HS	S	PN 250	25	G 1" -11	M 36 x 2	25	39	18	53	23.0	41
XVR NW 20 HS 1 1/4	S	PN 160	25	G 1.1/4" -11	M 36 x 2	25	49	20	56	24.0	50
XVR NW 25 HS 3/4	S	PN 160	30	G 3/4" -14	M 42 x 2	30	32	16	53	23.5	46
XVR NW 25 HS 1	S	PN 160	30	G 1" -11	M 42 x 2	30	39	18	55	23.5	46
XVR NW 25 HS	S	PN 160	30	G 1.1/4" -11	M 42 x 2	30	49	20	57	23.5	50
XVR NW 25 HS 1 1/2	S	PN 160	30	G 1.1/2" -11	M 42 x 2	30	55	22	50	23.5	55
XVR NW 32 HS 1	S	PN 160	38	G 1" -11	M 52 x 2	38	39	18	60	26.0	55
XVR NW 32 HS 1 1/4	S	PN 160	38	G 1.1/4" -11	M 52 x 2	38	49	20	62	26.0	55
XVR NW 32 HS	S	PN 160	38	G 1.1/2" -11	M 52 x 2	38	55	22	64	26.0	55

系列: LL=特轻系列 L=轻系列 S=重系列; G1= 接口螺纹 G2= 接口螺纹

端直通管接头 (英制圆柱管螺纹)

XVR-ED

结构形式: 端直通

连接1: BSP标准外螺纹

密封形式: E型

连接2: 公制外螺纹

密封形式: 24°内锥面密封

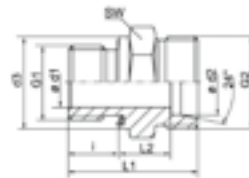

订货号	系列	工作压力 bar	Ød1 mm	Ød2 mm	G1	G2	管外径Ø mm	Ød3 mm	i mm	L1 mm	L2 mm	SW mm
XVR 04 LL ED	LL	PN 100	-	4	G 1/8" -28	M 8 x 1	4	14	8	20.0	9.5	14
XVR 06 LL ED	LL	PN 100	-	6	G 1/8" -28	M 10 x 1	6	14	8	20.0	8.0	14
XVR NW 04 HL ED	L	PN 315	-	6	G 1/8" -28	M 12 x 1.5	6	14	8	23.5	8.5	14
XVR NW 04 HL 1/4 ED	L	PN 315	-	6	G 1/4" -19	M 12 x 1.5	6	20	12	29.0	10.0	19
XVR NW 04 HL 1/2 ED	L	PN 315	-	6	G 1/2" -14	M 12 x 1.5	6	27	14	33.0	12.0	27
XVR NW 04 HL 3/8 ED	L	PN 315	-	6	G 3/8" -19	M 12 x 1.5	6	22	12	29.5	10.5	22
XVR NW 06 HL 1/8 ED	L	PN 315	-	8	G 1/8" -28	M 14 x 1.5	8	14	8	24.5	9.5	14
XVR NW 06 HL ED	L	PN 315	-	8	G 1/4" -19	M 14 x 1.5	8	19	12	29.0	10.0	19
XVR NW 06 HL 3/8 ED	L	PN 315	-	8	G 3/8" -19	M 14 x 1.5	8	22	12	30.5	11.5	22
XVR NW 06 HL 1/2 ED	L	PN 315	-	8	G 1/2" -14	M 14 x 1.5	8	27	14	33.0	12.0	27
XVR NW 08 HL 1/8 ED	L	PN 315	-	10	G 1/8" -28	M 16 x 1.5	10	14	8	25.5	10.5	19
XVR NW 08 HL ED	L	PN 315	-	10	G 1/4" -19	M 16 x 1.5	10	19	12	30.0	11.0	19
XVR NW 08 HL 3/8 ED	L	PN 315	-	10	G 3/8" -19	M 16 x 1.5	10	22	12	31.5	12.5	22
XVR NW 08 HL 1/2 ED	L	PN 315	-	10	G 1/2" -14	M 16 x 1.5	10	27	14	34.0	13.0	27
XVR NW 10 HL 1/4 ED	L	PN 315	-	12	G 1/4" -19	M 18 x 1.5	12	19	12	31.5	12.5	22
XVR NW 10 HL ED	L	PN 315	-	12	G 3/8" -19	M 18 x 1.5	12	22	12	31.5	12.5	22
XVR NW 10 HL 1/2 ED	L	PN 315	-	12	G 1/2" -14	M 18 x 1.5	12	27	14	34.0	13.0	27
XVR NW 10 HL 3/4 ED	L	PN 250	-	12	G 3/4" -14	M 18 x 1.5	12	32	16	36.0	13.0	32
XVR NW 13 HL 3/8 ED	L	PN 315	-	15	G 3/8" -19	M 22 x 1.5	15	22	12	33.0	14.0	27
XVR NW 13 HL ED	L	PN 315	-	15	G 1/2" -14	M 22 x 1.5	15	27	14	35.0	14.0	27
XVR NW 13 HL 3/4 ED	L	PN 250	-	15	G 3/4" -14	M 22 x 1.5	15	32	16	38.0	15.0	32
XVR NW 16 HL 3/8 ED	L	PN 315	-	18	G 3/8" -19	M 26 x 1.5	18	22	12	33.5	14.0	27
XVR NW 16 HL ED	L	PN 315	-	18	G 1/2" -14	M 26 x 1.5	18	27	14	36.0	14.5	27
XVR NW 16 HL 3/4 ED	L	PN 250	-	18	G 3/4" -14	M 26 x 1.5	18	32	16	38.0	14.5	32
XVR NW 20 HL 1/2 ED	L	PN 160	-	22	G 1/2" -14	M 30 x 2	22	27	14	38.0	16.5	32
XVR NW 20 HL ED	L	PN 160	-	22	G 3/4" -14	M 30 x 2	22	32	16	40.0	16.5	32
XVR NW 20 HL 1 ED	L	PN 160	-	22	G 1" -11	M 30 x 2	22	40	18	42.0	16.5	41
XVR NW 25 HL 3/4 ED	L	PN 160	-	28	G 3/4" -14	M 36 x 2	28	32	16	41.0	17.5	41
XVR NW 25 HL ED	L	PN 160	-	28	G 1" -11	M 36 x 2	28	40	18	43.0	17.5	41
XVR NW 25 HL 1/4 ED	L	PN 160	-	28	G 1.1/4" -11	M 36 x 2	28	50	20	46.0	18.5	50
XVR NW 32 HL 1 ED	L	PN 160	-	35	G 1" -11	M 45 x 2	35	40	18	46.0	17.5	50
XVR NW 32 HL ED	L	PN 160	-	35	G 1.1/4" -11	M 45 x 2	35	50	20	48.0	17.5	50
XVR NW 32 HL 11/2 ED	L	PN 160	30	35	G 1.1/2" -11	M 45 x 2	35	55	22	52.0	19.5	55
XVR NW 40 HL 1/4 ED	L	PN 160	-	42	G 1.1/4" -11	M 52 x 2	42	50	20	50.0	19.0	55
XVR NW 40 HL ED	L	PN 160	-	42	G 1.1/2" -11	M 52 x 2	42	55	22	52.0	19.0	55
XVR NW 03 HS ED	S	PN 630	-	6	G 1/4" -19	M 14 x 1.5	6	19	12	32.0	13.0	19
XVR NW 03 HS 1/2 ED	S	PN 630	-	6	G 1/2" -14	M 14 x 1.5	6	27	14	39.0	18.0	27
XVR NW 04 HS ED	S	PN 630	-	8	G 1/4" -19	M 16 x 1.5	8	19	12	34.0	15.0	19
XVR NW 04 HS 3/8 ED	S	PN 630	-	8	G 3/8" -19	M 16 x 1.5	8	22	12	34.5	15.5	22
XVR NW 06 HS 1/4 ED	S	PN 630	-	10	G 1/4" -19	M 18 x 1.5	10	19	12	34.0	14.5	22
XVR NW 06 HS ED	S	PN 630	-	10	G 3/8" -19	M 18 x 1.5	10	22	12	34.5	15.0	22
XVR NW 06 HS 1/2 ED	S	PN 630	-	10	G 1/2" -14	M 18 x 1.5	10	27	14	39.0	17.5	27
XVR NW 08 HS 1/4 ED	S	PN 630	-	12	G 1/4" -19	M 20 x 1.5	12	19	12	36.0	16.5	22
XVR NW 08 HS ED	S	PN 630	-	12	G 3/8" -19	M 20 x 1.5	12	22	12	36.5	17.0	22
XVR NW 08 HS 1/2 ED	S	PN 630	-	12	G 1/2" -14	M 20 x 1.5	12	27	14	39.0	17.5	27
XVR NW 10 HS 3/8 ED	S	PN 630	-	14	G 3/8" -19	M 22 x 1.5	14	22	12	38.5	18.5	27
XVR NW 10 HS ED	S	PN 630	-	14	G 1/2" -14	M 22 x 1.5	14	27	14	41.0	19.0	27
XVR NW 10 HS 3/4 ED	S	PN 630	-	14	G 3/4" -14	M 22 x 1.5	14	32	16	45.0	21.0	32
XVR NW 13 HS 3/8 ED	S	PN 400	-	16	G 3/8" -19	M 24 x 1.5	16	22	12	38.5	18.0	27
XVR NW 13 HS ED	S	PN 400	-	16	G 1/2" -14	M 24 x 1.5	16	27	14	41.0	18.5	27
XVR NW 13 HS 3/4 ED	S	PN 400	-	16	G 3/4" -14	M 24 x 1.5	16	32	16	45.0	20.5	32
XVR NW 13 HS 1 ED	S	PN 400	-	16	G 1" -11	M 24 x 1.5	16	39	18	45.5	18.8	41
XVR NW 16 HS 1/2 ED	S	PN 400	-	20	G 1/2" -14	M 30 x 2	20	27	14	45.0	20.5	32
XVR NW 16 HS ED	S	PN 400	-	20	G 3/4" -14	M 30 x 2	20	32	16	47.0	20.5	32
XVR NW 16 HS 1 ED	S	PN 400	-	20	G 1" -11	M 30 x 2	20	40	18	51.0	22.5	41
XVR NW 20 HS 1/2 ED	S	PN 400	-	25	G 1/2" -14	M 36 x 2	25	27	14	49.0	23.0	41
XVR NW 20 HS 3/4 ED	S	PN 400	-	25	G 3/4" -14	M 36 x 2	25	32	16	51.0	23.0	41
XVR NW 20 HS ED	S	PN 400	-	25	G 1" -11	M 36 x 2	25	40	18	53.0	23.0	41
XVR NW 25 HS 1 ED	S	PN 400	-	30	G 1" -11	M 42 x 2	30	40	18	55.0	23.5	50
XVR NW 25 HS ED	S	PN 400	-	30	G 1.1/4" -11	M 42 x 2	30	50	20	57.0	23.5	50
XVR NW 32 HS 1 1/4 ED	S	PN 315	-	38	G 1.1/4" -11	M 52 x 2	38	50	20	62.0	26.0	55
XVR NW 32 HS ED	S	PN 315	-	38	G 1.1/2" -11	M 52 x 2	38	55	22	64.0	26.0	55

结构系列: LL=特轻系列 L=轻系列 S=重系列; G1= 接口螺纹 G2= 接口螺纹

端直通管接头（公制锥管螺纹）

XVMK

结构形式：端直通

连接1：公制锥管外螺纹

密封形式：螺纹密封

连接2：公制外螺纹

密封形式：24°内锥面密封

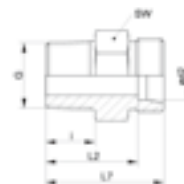

订货号	系列	工作压力 bar	Ød2 mm	G	管外径Ø mm	i mm	L2 mm	L7 mm	SW mm
XVM 04 LL 6	LL	PN 100	4	M 6 x 1 K	4	8	16.0	20	9
XVM 04 LL	LL	PN 100	4	M 8 x 1 K	4	8	16.0	20	9
XVM 04 LL 10	LL	PN 100	4	M 10 x 1 K	4	8	16.0	20	11
XVM 05 LL	LL	PN 100	5	M 8 x 1 K	5	8	14.5	20	11
XVM 06 LL 6	LL	PN 100	6	M 6 x 1 K	6	8	14.5	20	11
XVM 06 LL 8	LL	PN 100	6	M 8 x 1 K	6	8	14.5	20	11
XVM 06 LL	LL	PN 100	6	M 10 x 1 K	6	8	14.5	20	11
XVM 08 LL	LL	PN 100	8	M 10 x 1 K	8	8	16.5	22	12
XVM 12 LL	LL	PN 100	12	M 16 x 1.5 K	12	12	21.0	27	19
XVMK NW 04 HL	L	PN 315	6	M 10 x 1 K	6	8	15.0	22	12
XVMK NW 06 HL	L	PN 315	8	M 12 x 1.5 K	8	12	20.0	27	14
XVMK NW 08 HL	L	PN 315	10	M 14 x 1.5 K	10	12	21.0	28	17
XVMK NW 10 HL	L	PN 315	12	M 16 x 1.5 K	12	12	22.0	29	19
XVMK NW 13 HL	L	PN 315	15	M 18 x 1.5 K	15	12	23.0	30	24
XVMK NW 16 HL	L	PN 315	18	M 22 x 1.5 K	18	14	25.5	33	27
XVMK NW 20 HL	L	PN 160	22	M 26 x 1.5 k	22	18	31.5	39	32
XVMK NW 25 HL	L	PN 160	28	M 33 x 2 K	28	20	34.5	42	41
XVMK NW 32 HL	L	PN 160	35	M 42 x 2 K	35	21	35.5	46	46
XVMK NW 40 HL	L	PN 160	42	M 48 x 2 K	42	22	38.0	49	55
XVMK NW 03 HS	S	PN 630	6	M 12 x 1.5 K	6	12	24.0	31	14

结构系列：LL=特轻系列 L=轻系列 S=重系列；G=接口螺纹

端直通管接头（公制圆柱管螺纹）

XVM

结构形式：端直通

连接1：公制圆柱管螺纹

密封形式：B型

连接2：公制外螺纹

密封形式：24°内锥面密封

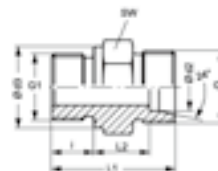

订货号	系列	工作压力 bar	Ød2 mm	G1	G2	管外径Ø mm	Ød3 mm	i mm	L1 mm	L2 mm	SW mm
XVM 16 LL	LL	PN 100	16	M 22 x 1.5	M 22 x 1.5	16	27	14	36.5	15.5	27
XVM 16 LL 18-1.5	LL	PN 100	16	M 18 x 1.5	M 22 x 1.5	16	23	12	33.5	14.5	24
XVM NW 04 HL	L	PN 315	6	M 10 x 1	M 12 x 1.5	6	14	8	23.5	8.5	14
XVM NW 04 HL 12	L	PN 315	6	M 12 x 1.5	M 12 x 1.5	6	17	12	28.0	9.0	17
XVM NW 04 HL 14	L	PN 315	6	M 14 x 1.5	M 12 x 1.5	6	19	12	28.0	9.0	19
XVM NW 04 HL 16	L	PN 315	6	M 16 x 1.5	M 12 x 1.5	6	21	12	28.0	9.0	22
XVM NW 04 HL 18	L	PN 315	6	M 18 x 1.5	M 12 x 1.5	6	23	12	28.5	9.5	24
XVM NW 04 HL 22	L	PN 315	6	M 22 x 1.5	M 12 x 1.5	6	27	14	31.0	10.0	27
XVM NW 06 HL	L	PN 315	8	M 12 x 1.5	M 14 x 1.5	8	17	12	29.0	10.0	17
XVM NW 06 HL 10	L	PN 315	8	M 10 x 1	M 14 x 1.5	8	14	8	24.5	9.5	17
XVM NW 06 HL 14	L	PN 315	8	M 14 x 1.5	M 14 x 1.5	8	19	12	29.0	10.0	19
XVM NW 06 HL 16	L	PN 315	8	M 16 x 1.5	M 14 x 1.5	8	21	12	29.0	10.0	22
XVM NW 06 HL 18	L	PN 315	8	M 18 x 1.5	M 14 x 1.5	8	23	12	29.5	10.5	24
XVM NW 06 HL 22	L	PN 315	8	M 22 x 1.5	M 14 x 1.5	8	27	14	32.0	11.0	27
XVM NW 08 HL	L	PN 315	10	M 14 x 1.5	M 16 x 1.5	10	19	12	30.0	11.0	19
XVM NW 08 HL 12	L	PN 315	10	M 12 x 1.5	M 16 x 1.5	10	17	12	30.0	11.0	17
XVM NW 08 HL 16	L	PN 315	10	M 16 x 1.5	M 16 x 1.5	10	21	12	30.0	11.0	22
XVM NW 08 HL 18	L	PN 315	10	M 18 x 1.5	M 16 x 1.5	10	23	12	30.5	11.5	24
XVM NW 08 HL 22	L	PN 315	10	M 22 x 1.5	M 16 x 1.5	10	27	14	33.0	12.0	27
XVM NW 10 HL	L	PN 315	12	M 16 x 1.5	M 18 x 1.5	12	21	12	31.5	12.5	22
XVM NW 10 HL 12	L	PN 315	12	M 12 x 1.5	M 18 x 1.5	12	17	12	31.5	12.5	19
XVM NW 10 HL 14	L	PN 315	12	M 14 x 1.5	M 18 x 1.5	12	19	12	31.5	12.5	22
XVM NW 10 HL 18	L	PN 315	12	M 18 x 1.5	M 18 x 1.5	12	23	12	32.0	13.0	24
XVM NW 10 HL 22	L	PN 315	12	M 22 x 1.5	M 18 x 1.5	12	27	14	34.5	13.5	27

端直通管接头 (公制圆柱管螺纹)

XVM

结构形式: 端直通

连接1: 公制圆柱管螺纹

密封形式: B型

连接2: 公制外螺纹

密封形式: 24°内锥面密封

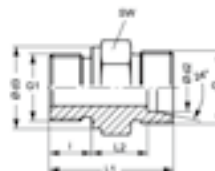

订货号	系列	工作压力 bar	Ød2 mm	G1	G2	管外径Ø mm	Ød3 mm	i mm	L1 mm	L2 mm	SW mm
XVM NW 10 HL 24	L	PN 315	12	M 24 x 1.5	M 18 x 1.5	12	29	14	34.5	13.5	32
XVM NW 10 HL 26	L	PN 315	12	M 26 x 1.5	M 18 x 1.5	12	31	16	36.5	13.5	32
XVM NW 13 HL	L	PN 315	15	M 18 x 1.5	M 22 x 1.5	15	23	12	32.5	13.5	24
XVM NW 13 HL 14	L	PN 315	15	M 14 x 1.5	M 22 x 1.5	15	19	12	32.0	13.0	24
XVM NW 13 HL 16	L	PN 315	15	M 16 x 1.5	M 22 x 1.5	15	21	12	32.0	13.0	24
XVM NW 13 HL 20	L	PN 250	15	M 20 x 1.5	M 22 x 1.5	15	25	14	34.5	13.5	27
XVM NW 13 HL 22	L	PN 315	15	M 22 x 1.5	M 22 x 1.5	15	27	14	35.0	14.0	27
XVM NW 13 HL 26	L	PN 315	15	M 26 x 1.5	M 22 x 1.5	15	31	16	37.0	14.0	32
XVM NW 13 HL 30	L	PN 315	15	M 30 x 2	M 22 x 1.5	15	36	16	37.0	14.0	41
XVM NW 16 HL	L	PN 315	18	M 22 x 1.5	M 26 x 1.5	18	27	14	36.0	14.5	27
XVM NW 16 HL 18	L	PN 315	18	M 18 x 1.5	M 26 x 1.5	18	23	12	33.5	14.0	27
XVM NW 16 HL 26	L	PN 315	18	M 26 x 1.5	M 26 x 1.5	18	31	16	38.0	14.5	32
XVM NW 16 HL 27	L	PN 315	18	M 27 x 2	M 26 x 1.5	18	32	16	38.0	14.5	32
XVM NW 16 HL 30-1.5	L	PN 315	18	M 30 x 1.5	M 26 x 1.5	18	36	16	38.0	14.5	41
XVM NW 20 HL	L	PN 160	22	M 26 x 1.5	M 30 x 2	22	31	16	40.0	16.5	32
XVM NW 20 HL 18	L	PN 160	22	M 18 x 1.5	M 30 x 2	22	23	12	35.5	16.0	32
XVM NW 20 HL 22	L	PN 160	22	M 22 x 1.5	M 30 x 2	22	27	14	38.0	16.5	32
XVM NW 20 HL 22-LS 20	L	PN 160	22	M 22 x 1.5	M 30 x 2	22	27	14	60.0	38.5	32
XVM NW 20 HL 30-1.5	L	PN 160	22	M 30 x 1.5	M 30 x 2	22	36	16	40.0	16.5	41
XVM NW 20 HL 33-LS 20	L	PN 160	22	M 33 x 2	M 30 x 2	22	39	18	62.0	36.5	41
XVM NW 25 HL	L	PN 160	28	M 33 x 2	M 36 x 2	28	39	18	43.0	17.5	41
XVM NW 25 HL-LS 20	L	PN 160	28	M 33 x 2	M 36 x 2	28	39	18	60.0	23.5	41
XVM NW 25 HL 22	L	PN 160	28	M 22 x 1.5	M 36 x 2	28	27	14	39.0	17.5	41
XVM NW 25 HL 26	L	PN 160	28	M 26 x 1.5	M 36 x 2	28	31	16	41.0	17.5	41
XVM NW 25 HL 27	L	PN 160	28	M 27 x 2	M 36 x 2	28	32	16	41.0	17.5	41
XVM NW 25 HL 42	L	PN 160	28	M 42 x 2	M 36 x 2	28	49	22	45.0	17.5	50
XVM NW 32 HL	L	PN 160	35	M 42 x 2	M 45 x 2	35	49	20	48.0	17.5	50
XVM NW 40 HL	L	PN 160	42	M 48 x 2	M 52 x 2	42	55	22	52.0	19.0	55
XVM NW 03 HS	S	PN 400	6	M 12 x 1.5	M 14 x 1.5	6	17	12	32.0	13.0	17
XVM NW 03 HS 16	S	PN 400	6	M 16 x 1.5	M 14 x 1.5	6	21	12	32.0	13.0	22
XVM NW 03 HS 18	S	PN 400	6	M 18 x 1.5	M 14 x 1.5	6	23	12	32.5	13.5	24
XVM NW 03 HS 22	S	PN 400	6	M 22 x 1.5	M 14 x 1.5	6	27	14	35.0	14.0	27
XVM NW 04 HS	S	PN 400	8	M 14 x 1.5	M 16 x 1.5	8	19	12	34.0	15.0	19
XVM NW 06 HS	S	PN 400	10	M 16 x 1.5	M 18 x 1.5	10	21	12	34.5	15.0	22
XVM NW 06 HS 18	S	PN 400	10	M 18 x 1.5	M 18 x 1.5	10	23	12	35.0	15.5	24
XVM NW 06 HS 22	S	PN 400	10	M 22 x 1.5	M 18 x 1.5	10	27	14	37.5	16.0	27
XVM NW 08 HS	S	PN 400	12	M 18 x 1.5	M 20 x 1.5	12	23	12	36.5	17.0	24
XVM NW 08 HS 14	S	PN 400	12	M 14 x 1.5	M 20 x 1.5	12	19	12	36.0	16.5	22
XVM NW 08 HS 16	S	PN 400	12	M 16 x 1.5	M 20 x 1.5	12	21	12	36.0	16.5	22
XVM NW 08 HS 22	S	PN 400	12	M 22 x 1.5	M 20 x 1.5	12	27	14	39.0	17.5	27
XVM NW 10 HS	S	PN 400	14	M 20 x 1.5	M 22 x 1.5	14	25	14	41.0	19.0	27
XVM NW 10 HS 16	S	PN 400	14	M 16 x 1.5	M 22 x 1.5	14	21	12	38.5	18.5	24
XVM NW 10 HS 18	S	PN 400	14	M 18 x 1.5	M 22 x 1.5	14	23	12	39.0	19.0	24
XVM NW 10 HS 22	S	PN 400	14	M 22 x 1.5	M 22 x 1.5	14	27	14	41.5	19.5	27
XVM NW 13 HS	S	PN 400	16	M 22 x 1.5	M 24 x 1.5	16	27	14	41.0	18.5	27
XVM NW 13 HS 16	S	PN 400	16	M 16 x 1.5	M 24 x 1.5	16	21	12	38.0	17.5	27
XVM NW 13 HS 18	S	PN 400	16	M 18 x 1.5	M 24 x 1.5	16	23	12	38.5	18.0	27
XVM NW 13 HS 26	S	PN 400	16	M 26 x 1.5	M 24 x 1.5	16	31	16	43.0	18.5	32
XVM NW 16 HS	S	PN 400	20	M 27 x 2	M 30 x 2	20	32	16	47.0	20.5	32
XVM NW 16 HS 22	S	PN 400	20	M 22 x 1.5	M 30 x 2	20	27	14	45.0	20.5	32
XVM NW 16 HS 26	S	PN 400	20	M 26 x 1.5	M 30 x 1.5	20	32	16	47.0	20.5	32
XVM NW 16 HS 30-1.5	S	PN 400	20	M 30 x 1.5	M 30 x 2	20	36	16	47.0	20.5	36
XVM NW 20 HS	S	PN 250	25	M 33 x 2	M 36 x 2	25	39	18	53.0	23.0	41
XVM NW 20 HS 26	S	PN 250	25	M 26 x 1.5	M 36 x 2	25	32	16	49.0	20.0	41
XVM NW 20 HS 27	S	PN 250	25	M 27 x 2	M 36 x 2	25	32	16	51.0	23.0	41
XVM NW 20 HS 30-1.5	S	PN 250	25	M 30 x 1.5	M 36 x 2	25	36	16	51.0	23.0	41
XVM NW 25 HS	S	PN 160	30	M 42 x 2	M 42 x 2	30	49	20	57.0	23.5	50
XVM NW 25 HS 30-1.5	S	PN 160	30	M 30 x 1.5	M 42 x 2	30	36	16	53.0	23.5	50
XVM NW 25 HS 38-1.5	S	PN 160	30	M 38 x 1.5	M 42 x 2	30	44	16	49.0	19.5	46
XVM NW 32 HS	S	PN 160	38	M 48 x 2	M 52 x 2	38	55	22	64.0	26.0	55
XVM NW 32 HS 38-1.5	S	PN 160	38	M 38 x 1.5	M 52 x 2	38	49	20	58.0	26.0	50
XVM NW 32 HS 45-1.5	S	PN 160	38	M 45 x 1.5	M 52 x 2	38	55	22	58.0	26.0	55

结构系列: LL=特轻系列 L=轻系列 S=重系列; G1=接口螺纹 G2=接口螺纹

端直通管接头（公制圆柱管螺纹）

XVM-ED

结构形式：端直通
 连接1：公制圆柱管螺纹
 密封形式：E型
 连接2：公制外螺纹
 密封形式：24°内锥面密封

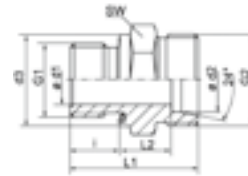

订货号	系列	工作压力 bar	Ød2 mm	G1	G2	管外径Ø mm	Ød3 mm	i mm	L1 mm	L2 mm	SW mm
XVM NW 04 HL ED	L	PN 315	6	M 10 x 1	M 12 x 1.5	6	13.9	8	23.5	8.5	14
XVM NW 04 HL 12 ED	L	PN 315	6	M 12 x 1.5	M 12 x 1.5	6	16.9	12	28.0	9.0	17
XVM NW 06 HL ED	L	PN 315	8	M 12 x 1.5	M 14 x 1.5	8	16.9	12	29.0	10.0	17
XVM NW 06 HL 14 ED	L	PN 315	8	M 14 x 1.5	M 14 x 1.5	8	18.9	12	29.0	10.0	19
XVM NW 06 HL 16 ED	L	PN 315	8	M 16 x 1.5	M 14 x 1.5	8	21.9	12	30.5	11.5	22
XVM NW 06 HL 18 ED	L	PN 315	8	M 18 x 1.5	M 14 x 1.5	8	23.9	12	30.5	11.5	24
XVM NW 08 HL ED	L	PN 315	10	M 14 x 1.5	M 16 x 1.5	10	18.9	12	30.0	11.0	19
XVM NW 08 HL 10 ED	L	PN 315	10	M 10 x 1	M 16 x 1.5	10	-	-	-	-	-
XVM NW 08 HL 12 ED	L	PN 315	10	M 12 x 1.5	M 16 x 1.5	10	16.9	12	30.0	11.0	19
XVM NW 08 HL 16 ED	L	PN 315	10	M 16 x 1.5	M 16 x 1.5	10	21.9	12	31.5	12.5	22
XVM NW 08 HL 18 ED	L	PN 315	10	M 18 x 1.5	M 16 x 1.5	10	23.9	12	31.5	12.5	24
XVM NW 08 HL 22 ED	L	PN 315	10	M 22 x 1.5	M 16 x 1.5	10	26.9	14	35.0	14.0	27
XVM NW 10 HL ED	L	PN 315	12	M 16 x 1.5	M 18 x 1.5	12	21.9	12	31.5	12.5	22
XVM NW 10 HL 14 ED	L	PN 315	12	M 14 x 1.5	M 18 x 1.5	12	18.9	12	31.5	12.5	22
XVM NW 10 HL 18 ED	L	PN 315	12	M 18 x 1.5	M 18 x 1.5	12	23.9	12	32.0	13.0	24
XVM NW 10 HL 22 ED	L	PN 315	12	M 22 x 1.5	M 18 x 1.5	12	26.9	14	35.0	14.0	27
XVM NW 13 HL ED	L	PN 315	15	M 18 x 1.5	M 22 x 1.5	15	23.9	12	32.5	13.5	24
XVM NW 13 HL 16 ED	L	PN 315	15	M 16 x 1.5	M 22 x 1.5	15	21.9	12	32.0	13.0	24
XVM NW 13 HL 22 ED	L	PN 315	15	M 22 x 1.5	M 22 x 1.5	15	26.9	14	35.0	14.0	27
XVM NW 16 HL ED	L	PN 315	18	M 22 x 1.5	M 26 x 1.5	18	26.9	14	36.0	14.5	27
XVM NW 16 HL 18 ED	L	PN 315	18	M 18 x 1.5	M 26 x 1.5	18	23.9	12	33.5	14.0	27
XVM NW 20 HL ED	L	PN 160	22	M 26 x 1.5	M 30 x 2	22	31.9	16	40.0	16.5	32
XVM NW 20 HL 22 ED	L	PN 160	22	M 22 x 1.5	M 30 x 2	22	26.9	14	38.0	16.5	32
XVM NW 25 HL ED	L	PN 160	28	M 33 x 2	M 36 x 2	28	39.9	18	43.0	17.5	41
XVM NW 32 HL ED	L	PN 160	35	M 42 x 2	M 45 x 2	35	49.9	20	48.0	17.5	50
XVM NW 40 HL ED	L	PN 160	42	M 48 x 2	M 52 x 2	42	54.9	22	52.0	19.0	55
XVM NW 03 HS ED	S	PN 630	6	M 12 x 1.5	M 14 x 1.5	6	16.9	12	32.0	13.0	17
XVM NW 04 HS ED	S	PN 630	8	M 14 x 1.5	M 16 x 1.5	8	18.9	12	34.0	15.0	19
XVM NW 06 HS ED	S	PN 630	10	M 16 x 1.5	M 18 x 1.5	10	21.9	12	34.5	15.0	22
XVM NW 08 HS ED	S	PN 630	12	M 18 x 1.5	M 20 x 1.5	12	23.9	12	36.5	17.0	24
XVM NW 08 HS 22 ED	S	PN 400	12	M 22 x 1.5	M 20 x 1.5	12	26.9	14	39.0	17.5	27
XVM NW 10 HS ED	S	PN 630	14	M 20 x 1.5	M 22 x 1.5	14	25.9	14	41.0	19.0	27
XVM NW 13 HS 18 ED	S	PN 400	16	M 18 x 1.5	M 24 x 1.5	16	23.9	12	38.5	18.0	27
XVM NW 13 HS ED	S	PN 400	16	M 22 x 1.5	M 24 x 1.5	16	26.9	14	41.0	18.5	27
XVM NW 16 HS ED	S	PN 400	20	M 27 x 2	M 30 x 2	20	31.9	16	47.0	20.5	32
XVM NW 20 HS ED	S	PN 400	25	M 33 x 2	M 36 x 2	25	39.9	18	53.0	23.0	41
XVM NW 25 HS ED	S	PN 400	30	M 42 x 2	M 42 x 2	30	49.9	20	57.0	23.5	50
XVM NW 32 HS ED	S	PN 315	38	M 48 x 2	M 52 x 2	38	54.9	22	64.0	26.0	55

结构系列：LL=特轻系列 L=轻系列 S=重系列；G1=接口螺纹 G2=接口螺纹

端直通管接头（公制圆柱管螺纹）

XVMO

结构形式：端直通

连接1：公制圆柱管螺纹

密封形式：F型

连接2：公制外螺纹

密封形式：24°内锥面密封

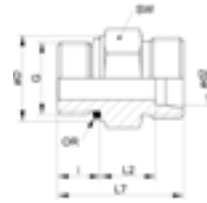

订货号	系列	工作压力 bar	Ød2 mm	管外径Ø mm	G	Ø D mm	i mm	L2 mm	L7 mm	SW mm	OR
XVMO 04 LL	LL	PN 100	4	4	M 8 x 1	10.8	6.5	9.5	20.0	11	6.1 x 1.6
XVMO 04 LL 10	LL	PN 100	4	4	M 10 x 1	12.8	6.5	9.5	20.0	13	8.0 x 1.5
XVMO 06 LL	LL	PN 100	6	6	M 10 x 1	12.8	6.5	8.0	20.0	13	8.0 x 1.5
XVMO NW 04 HL	L	PN 250	6	6	M 10 x 1	14.0	8.5	8.5	24.0	14	8.0 x 1.5
XVMO NW 06 HL	L	PN 250	8	8	M 12 x 1.5	17.0	11.0	10.0	28.0	17	9.3 x 2.4
XVMO NW 08 HL	L	PN 250	10	10	M 14 x 1.5	19.0	11.0	11.0	29.0	19	11.3 x 2.4
XVMO NW 10 HL	L	PN 250	12	12	M 16 x 1.5	22.0	11.5	12.5	31.0	22	13.3 x 2.4
XVMO NW 10 HL 18	L	PN 315	12	12	M 18 x 1.5	24.0	12.0	12.5	31.5	24	15.3 x 2.4
XVMO NW 13 HL	L	PN 250	15	15	M 18 x 1.5	24.0	12.5	13.5	33.0	24	15.3 x 2.4
XVMO NW 13 HL 22	L	PN 315	15	15	M 22 x 1.5	27.0	13.0	15.0	35.0	27	19.3 x 2.4
XVMO NW 16 HL	L	PN 160	18	18	M 22 x 1.5	27.0	13.0	14.5	35.0	27	19.3 x 2.4
XVMO NW 20 HL	L	PN 160	22	22	M 26 x 1.5	31.0	16.0	17.5	41.0	41	23.3 x 2.4
XVMO NW 20 HL 27	L	PN 160	22	22	M 27 x 2	32.0	16.0	16.5	40.0	32	23.6 x 2.9
XVMO NW 25 HL	L	PN 100	28	28	M 33 x 2	41.0	16.0	17.5	41.0	41	29.5 x 3.0
XVMO NW 32 HL	L	PN 100	35	35	M 42 x 2	50.0	16.0	17.5	44.0	50	38.0 x 3.0
XVMO NW 40 HL	L	PN 160	42	42	M 48 x 2	55.0	17.5	19.0	47.5	55	44.6 x 3.0
XVMO NW 03 HS	S	PN 630	6	6	M 12 x 1.5	17.0	11.0	13.0	31.0	17	9.3 x 2.4
XVMO NW 04 HS	S	PN 630	8	8	M 14 x 1.5	19.0	11.0	15.0	33.0	19	11.3 x 2.4
XVMO NW 06 HS	S	PN 630	10	10	M 16 x 1.5	22.0	12.5	15.0	35.0	22	13.3 x 2.4
XVMO NW 08 HS	S	PN 630	12	12	M 18 x 1.5	24.0	14.0	17.0	38.5	24	15.3 x 2.4
XVMO NW 13 HS	S	PN 400	16	16	M 22 x 1.5	27.0	15.0	18.5	42.0	27	19.3 x 2.4
XVMO NW 16 HS	S	PN 400	20	20	M 27 x 2	32.0	18.5	20.5	19.5	32	23.5 x 3.0
XVMO NW 20 HS	S	PN 400	25	25	M 33 x 2	41.0	18.5	23.0	53.5	41	29.5 x 3.0
XVMO NW 25 HS	S	PN 250	30	30	M 42 x 2	50.0	19.0	23.5	56.0	50	38.0 x 3.0
XVMO NW 32 HS	S	PN 315	38	38	M 48 x 2	55.0	21.5	26.0	63.5	55	46.7 x 2.8

结构系列：LL=特轻系列 L=轻系列 S=重系列；G=接口螺纹

端直通管接头 (NPT螺纹)

XVN

结构形式: 端直通

连接1: NPT外螺纹

密封形式: 螺纹密封

连接2: 公制外螺纹

密封形式: 24°内锥面密封

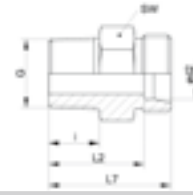

订货号	系列	工作压力 bar	Ød2 mm	管外径Ø mm	G	i mm	L2 mm	L7 mm	SW mm
XVN 04 LL	LL	PN 100	4	4	1/8" -27 NPT	10.0	18.0	22.0	11
XVN 05 LL	LL	PN 100	5	5	1/8" -27 NPT	10.0	16.5	22.0	11
XVN 06 LL	LL	PN 100	6	6	1/8" -27 NPT	10.0	16.5	22.0	11
XVN 08 LL	LL	PN 100	8	8	1/8" -27 NPT	10.0	18.5	24.0	12
XVN NW 04 HL	L	PN 315	6	6	1/8" -27 NPT	10.0	17.0	24.0	12
XVN NW 04 HL 1/4	L	PN 315	6	6	1/4" -18 NPT	15.0	23.0	30.0	17
XVN NW 04 HL 3/8	L	PN 315	6	6	3/8" -18 NPT	15.3	24.0	31.0	19
XVN NW 04 HL 1/2	L	PN 315	6	6	1/2" -14 NPT	20.0	29.0	36.0	24
XVN NW 06 HL 1/8	L	PN 315	8	8	1/8" -27 NPT	10.0	18.0	25.0	17
XVN NW 06 HL	L	PN 315	8	8	1/4" -18 NPT	15.0	23.0	30.0	17
XVN NW 06 HL 3/8	L	PN 315	8	8	3/8" -18 NPT	15.3	24.0	31.0	19
XVN NW 06 HL 1/2	L	PN 315	8	8	1/2" -14 NPT	20.0	29.0	36.0	24
XVN NW 08 HL 1/8	L	PN 315	10	10	1/8" -27 NPT	10.0	19.0	26.0	17
XVN NW 08 HL	L	PN 315	10	10	1/4" -18 NPT	15.0	24.0	31.0	17
XVN NW 08 HL 3/8	L	PN 315	10	10	3/8" -18 NPT	15.3	25.0	32.0	19
XVN NW 08 HL 1/2	L	PN 315	10	10	1/2" -14 NPT	20.0	30.0	37.0	24
XVN NW 10 HL 1/8	L	PN 315	12	12	1/8" -27 NPT	10.0	19.5	26.5	19
XVN NW 10 HL 1/4	L	PN 315	12	12	1/4" -18 NPT	15.0	25.0	32.0	19
XVN NW 10 HL	L	PN 315	12	12	3/8" -18 NPT	15.3	25.0	32.0	19
XVN NW 10 HL 1/2	L	PN 315	12	12	1/2" -14 NPT	20.0	30.0	37.0	24
XVN NW 10 HL 3/4	L	PN 315	12	12	3/4" -14 NPT	20.2	31.0	38.0	27
XVN NW 13 HL 1/4	L	PN 315	15	15	1/4" -18 NPT	15.0	26.0	33.0	24
XVN NW 13 HL 3/8	L	PN 315	15	15	3/8" -18 NPT	15.3	26.5	33.5	24
XVN NW 13 HL	L	PN 315	15	15	1/2" -14 NPT	20.0	31.0	38.0	24
XVN NW 13 HL 3/4	L	PN 315	15	15	3/4" -14 NPT	20.2	32.0	39.0	27
XVN NW 16 HL 1/4	L	PN 315	18	18	1/4" -18 NPT	15.0	26.5	34.0	27
XVN NW 16 HL	L	PN 315	18	18	1/2" -14 NPT	20.0	31.5	39.0	27
XVN NW 16 HL 3/4	L	PN 315	18	18	3/4" -14 NPT	20.2	31.5	39.0	27
XVN NW 20 HL 1/2	L	PN 160	22	22	1/2" -14 NPT	20.0	33.5	41.0	32
XVN NW 20 HL	L	PN 160	22	22	3/4" -14 NPT	20.2	33.5	41.0	32
XVN NW 25 HL	L	PN 160	28	28	1" -11.5 NPT	25.0	39.5	47.0	41
XVN NW 32 HL 1	L	PN 160	35	35	1" -11.5 NPT	25.0	40.0	50.5	46
XVN NW 32 HL	L	PN 160	35	35	1.1/4" -11.5 NPT	25.6	40.5	51.0	46
XVN NW 40 HL	L	PN 160	42	42	1.1/2" -11.5 NPT	26.0	42.0	53.0	55
XVN NW 03 HS	S	PN 630	6	6	1/4" -18 NPT	15.0	28.0	35.0	17
XVN NW 03 HS 1/2	S	PN 630	6	6	1/2" -14 NPT	20.0	35.0	42.0	24
XVN NW 04 HS	S	PN 630	8	8	1/4" -18 NPT	15.0	28.0	35.0	17
XVN NW 04 HS 3/8	S	PN 630	8	8	3/8" -18 NPT	15.3	28.0	35.0	19
XVN NW 06 HS 1/4	S	PN 630	10	10	1/4" -18 NPT	15.0	27.5	35.0	19
XVN NW 06 HS	S	PN 630	10	10	3/8" -18 NPT	15.3	27.5	35.0	19
XVN NW 06 HS 1/2	S	PN 630	10	10	1/2" -14 NPT	20.0	34.5	42.0	24
XVN NW 08 HS 1/4	S	PN 630	12	12	1/4" -18 NPT	15.0	29.0	36.5	22
XVN NW 08 HS	S	PN 630	12	12	3/8" -18 NPT	15.3	29.5	37.0	22
XVN NW 08 HS 1/2	S	PN 630	12	12	1/2" -14 NPT	20.0	34.5	42.0	24
XVN NW 10 HS 3/8	S	PN 630	14	14	3/8" -18 NPT	15.3	31.5	39.5	24
XVN NW 10 HS	S	PN 630	14	14	1/2" -14 NPT	20.0	36.0	44.0	24
XVN NW 13 HS	S	PN 400	16	16	1/2" -14 NPT	20.0	35.5	44.0	27
XVN NW 13 HS 3/4	S	PN 400	16	16	3/4" -14 NPT	20.2	37.5	46.0	32
XVN NW 16 HS 1/2	S	PN 400	20	20	1/2" -14 NPT	20.0	37.5	48.0	32
XVN NW 16 HS	S	PN 400	20	20	3/4" -14 NPT	20.2	37.5	48.0	32
XVN NW 16 HS 1	S	PN 400	20	20	1" -11.5 NPT	25.0	44.5	55.0	41
XVN NW 20 HS 3/4	S	PN 400	25	25	3/4" -14 NPT	20.2	40.0	52.0	41
XVN NW 20 HS	S	PN 400	25	25	1" -11.5 NPT	25.0	45.0	57.0	41
XVN NW 20 HS 1 1/4	S	PN 400	25	25	1.1/4" -11.5 NPT	25.6	46.0	58.0	46
XVN NW 25 HS 1	S	PN 400	30	30	1" -11.5 NPT	25.0	46.0	59.5	46
XVN NW 25 HS	S	PN 400	30	30	1.1/4" -11.5 NPT	25.6	46.5	60.0	46
XVN NW 32 HS	S	PN 315	38	38	1.1/2" -11.5 NPT	26.0	49.0	65.0	55

结构系列: LL=特轻系列 L=轻系列 S=重系列; G=接口螺纹

端直通管接头 (UN/UNF螺纹)

XVU

结构形式: 端直通

连接1: UN/UNF外螺纹

密封形式: F型

连接2: 公制外螺纹

密封形式: 24°内锥面密封

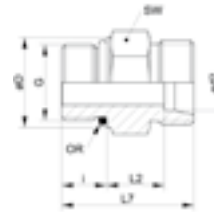

订货号	系列	工作压力 bar	Ød2 mm	管外径Ø mm	G	ØD mm	i mm	L2 mm	L7 mm	SW mm	OR
XVU NW 04 HL 7/16	L	PN 315	6	6	7/16" -20 UNF	14.4	9.1	9.9	26.0	17	9.17 x 1.83
XVU NW 04 HL 1/2	L	PN 315	6	6	1/2" -20 UNF	16.8	9.1	9.9	26.0	17	10.52 x 1.83
XVU NW 04 HL 9/16	L	PN 315	6	6	9/16" -18 UNF	17.6	10.0	11.0	28.0	19	11.89 x 1.98
XVU NW 06 HL 7/16	L	PN 315	8	8	7/16" -20 UNF	14.4	9.1	12.9	29.0	17	9.17 x 1.83
XVU NW 06 HL 1/2	L	PN 315	8	8	1/2" -20 UNF	16.8	9.1	12.9	29.0	17	10.52 x 1.83
XVU NW 06 HL 9/16	L	PN 315	8	8	9/16" -18 UNF	17.6	10.0	13.0	30.0	19	11.89 x 1.98
XVU NW 08 HL 7/16	L	PN 315	10	10	7/16" -20 UNF	14.4	9.1	13.9	30.0	17	9.17 x 1.83
XVU NW 08 HL 9/16	L	PN 315	10	10	9/16" -18 UNF	17.6	10.0	14.0	31.0	19	11.89 x 1.98
XVU NW 08 HL 3/4	L	PN 315	10	10	3/4" -16 UNF	22.3	11.1	14.9	33.0	24	16.36 x 2.20
XVU NW 10 HL 9/16	L	PN 315	12	12	9/16" -18 UNF	17.6	10.0	12.0	29.0	19	11.89 x 1.98
XVU NW 10 HL 3/4	L	PN 315	12	12	3/4" -16 UNF	22.3	11.1	12.9	31.0	24	16.36 x 2.20
XVU NW 10 HL 7/8	L	PN 315	12	12	7/8" -14 UNF	25.5	12.7	14.3	34.0	27	19.18 x 2.46
XVU NW 13 HL 9/16	L	PN 315	15	15	9/16" -18 UNF	17.6	10.0	14.0	31.0	24	11.89 x 1.98
XVU NW 13 HL 3/4	L	PN 315	15	15	3/4" -16 UNF	22.3	11.1	13.9	32.0	24	16.36 x 2.20
XVU NW 13 HL 7/8	L	PN 315	15	15	7/8" -14 UNF	25.5	12.7	15.8	35.5	27	19.18 x 2.46
XVU NW 16 HL 3/4	L	PN 315	18	18	3/4" -16 UNF	22.3	11.1	14.4	33.0	27	16.36 x 2.20
XVU NW 16 HL 7/8	L	PN 315	18	18	7/8" -14 UNF	25.5	12.7	14.5	34.7	27	19.18 x 2.46
XVU NW 16 HL 1 1/16	L	PN 315	18	18	1.1/16" -12 UN	31.9	15.1	14.4	37.0	32	23.47 x 2.95
XVU NW 20 HL 7/8	L	PN 160	22	22	7/8" -14 UNF	25.5	12.7	16.8	37.0	32	19.18 x 2.46
XVU NW 20 HL 1 1/16	L	PN 160	22	22	1.1/16" -12 UN	31.9	15.1	16.4	39.0	32	23.47 x 2.95
XVU NW 20 HL 1 5/16	L	PN 160	22	22	1.5/16" -12 UN	38.2	15.1	17.4	40.0	41	29.74 x 2.95
XVU NW 25 HL 7/8	L	PN 160	28	28	7/8" -14 UNF	25.5	12.7	19.8	40.0	41	19.18 x 2.46
XVU NW 25 HL 1 1/16	L	PN 160	28	28	1.1/16" -12 UN	31.9	15.1	17.4	40.0	41	23.47 x 2.95
XVU NW 25 HL 1 5/16	L	PN 160	28	28	1.5/16" -12 UN	38.2	15.1	17.4	40.0	41	29.74 x 2.95
XVU NW 32 HL 1 5/16	L	PN 160	35	35	1.5/16" -12 UN	38.2	15.1	17.4	43.0	46	29.74 x 2.95
XVU NW 32 HL 1 5/8	L	PN 160	35	35	1.5/8" -12 UN	47.7	15.1	17.4	43.0	50	37.47 x 3.00
XVU NW 40 HL 1 5/8	L	PN 160	42	42	1.5/8" -12 UN	47.7	15.1	18.9	45.0	55	37.47 x 3.00
XVU NW 40 HL 1 7/8	L	PN 160	42	42	1.7/8" -12 UN	53.8	15.1	18.9	45.0	60	43.69 x 3.00
XVU NW 03 HS 7/16	S	PN 630	6	6	7/16" -20 UNF	14.4	9.1	14.9	31.0	17	9.17 x 1.83
XVU NW 04 HS 7/16	S	PN 630	8	8	7/16" -20 UNF	14.4	9.1	14.9	31.0	17	9.17 x 1.83
XVU NW 04 HS 1/2	S	PN 630	8	8	1/2" -20 UNF	16.8	9.1	14.9	31.0	19	10.52 x 1.83
XVU NW 04 HS 9/16	S	PN 630	8	8	9/16" -18 UNF	17.6	10.0	15.0	32.0	19	11.89 x 1.98
XVU NW 06 HS 9/16	S	PN 630	10	10	9/16" -18 UNF	17.6	10.0	14.5	32.0	19	10.89 x 1.98
XVU NW 06 HS 3/4	S	PN 630	10	10	3/4" -16 UNF	22.3	11.1	14.4	33.0	24	16.36 x 2.20
XVU NW 08 HS 9/16	S	PN 630	12	12	9/16" -18 UNF	17.6	10.0	14.5	32.0	22	11.89 x 1.98
XVU NW 08 HS 3/4	S	PN 630	12	12	3/4" -16 UNF	22.3	11.1	17.4	36.0	24	16.36 x 2.20
XVU NW 08 HS 7/8	S	PN 630	12	12	7/8" -14 UNF	25.5	12.7	17.8	38.0	27	19.18 x 2.46
XVU NW 10 HS 3/4	S	PN 630	14	14	3/4" -16 UNF	22.3	11.1	15.9	35.0	24	16.36 x 2.20
XVU NW 13 HS 3/4	S	PN 400	16	16	3/4" -16 UNF	22.3	11.1	15.4	35.0	24	16.36 x 2.20
XVU NW 13 HS 7/8	S	PN 400	16	16	7/8" -14 UNF	25.5	12.7	18.8	40.0	27	19.18 x 2.46
XVU NW 13 HS 1 1/16	S	PN 400	16	16	1.1/16" -12 UN	31.9	15.1	20.4	44.0	32	23.47 x 2.95
XVU NW 16 HS 3/4	S	PN 400	20	20	3/4" -16 UNF	22.3	11.1	20.4	42.0	32	16.36 x 2.20
XVU NW 16 HS 7/8	S	PN 400	20	20	7/8" -14 UNF	25.5	12.7	20.8	44.0	32	19.18 x 2.46
XVU NW 16 HS 1 1/16	S	PN 400	20	20	1.1/16" -12 UN	31.9	15.1	20.4	46.0	32	23.47 x 2.95
XVU NW 20 HS 1 1/16	S	PN 400	25	25	1.1/16" -12 UN	31.9	15.1	22.9	50.0	41	23.47 x 2.95
XVU NW 20 HS 1 5/16	S	PN 400	25	25	1.5/16" -12 UN	38.2	15.1	22.9	50.0	41	29.74 x 2.95
XVU NW 25 HS 1 5/16	S	PN 400	30	30	1.5/16" -12 UN	38.2	15.1	23.4	52.0	46	29.74 x 2.95
XVU NW 25 HS 1 5/8	S	PN 400	30	30	1.5/8" -12 UN	47.7	15.1	23.4	52.0	50	37.47 x 3.00
XVU NW 32 HS 1 5/8	S	PN 315	38	38	1.5/8" -12 UN	47.7	15.1	25.9	57.0	55	37.47 x 3.00
XVU NW 32 HS 1 7/8	S	PN 315	38	38	1.7/8" -12 UN	53.8	15.1	25.9	57.0	60	43.69 x 3.00

结构系列: LL=特轻系列 L=轻系列 S=重系列; G=接口螺纹

端直角管接头 (英制锥管螺纹)

结构形式: 90°角
 连接1: BSPT标准外螺纹
 密封形式: 螺纹密封
 连接2: 公制外螺纹
 密封形式: 24°内锥面密封

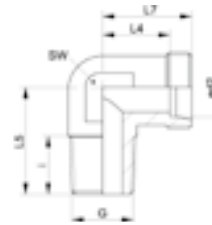

XWRK



订货号	系列	工作压力 bar	Ød2 mm	管外径Ø mm	G	i mm	L4 mm	L5 mm	L7 mm	SW mm
XWR 04 LL	LL	PN 100	4	4	R 1/8" K	8	11.0	17.0	15.0	9
XWR 05 LL	LL	PN 100	5	5	R 1/8" K	8	8.0	17.0	13.5	9
XWR 06 LL	LL	PN 100	6	6	R 1/8" K	8	9.5	17.0	15.0	9
XWR 08 LL	LL	PN 100	8	8	R 1/8" K	8	11.5	20.0	17.0	12
XWR 10 LL	LL	PN 100	10	10	R 1/4" K	12	15.5	26.0	21.0	14
XWR 12 LL	LL	PN 100	12	12	R 1/4" K	12	12.0	21.5	18.0	17
XWR NW 04 HL	L	PN 315	6	6	R 1/8" K	8	12.0	20.0	19.0	12
XWR NW 04 HL 1/4	L	PN 315	6	6	R 1/4" K	12	14.0	26.0	21.0	12
XWR NW 04 HL 3/8	L	PN 315	6	6	R 3/8" K	12	17.0	28.0	24.0	17
XWR NW 06 HL	L	PN 315	8	8	R 1/4" K	12	14.0	26.0	21.0	12
XWR NW 06 HL 1/8	L	PN 315	8	8	R 1/8" K	8	14.0	26.0	21.0	12
XWR NW 06 HL 3/8	L	PN 315	8	8	R 3/8" K	12	19.0	28.0	26.0	17
XWR NW 06 HL 1/2	L	PN 315	8	8	R 1/2" K	13	20.0	34.0	27.0	19
XWR NW 08 HL	L	PN 315	10	10	R 1/4" K	12	15.0	27.0	22.0	14
XWR NW 08 HL 1/8	L	PN 315	10	10	R 1/8" K	8	15.0	27.0	22.0	14
XWR NW 08 HL 3/8	L	PN 315	10	10	R 3/8" K	12	17.0	28.0	24.0	17
XWR NW 08 HL 1/2	L	PN 316	10	10	R 1/2" K	14	23.0	34.0	30.0	19
XWR NW 10 HL	L	PN 315	12	12	R 3/8" K	12	17.0	28.0	24.0	17
XWR NW 10 HL 1/4	L	PN 315	12	12	R 1/4" K	12	17.0	28.0	24.0	17
XWR NW 10 HL 1/2	L	PN 315	12	12	R 1/2" K	14	23.0	34.0	30.0	19
XWR NW 10 HL 3/4	L	PN 315	12	12	R 3/4" K	16	28.0	42.0	35.0	27
XWR NW 13 HL	L	PN 315	15	15	R 1/2" K	14	21.0	34.0	28.0	19
XWR NW 13 HL 1/4	L	PN 315	15	15	R 1/4" K	12	21.0	34.0	28.0	19
XWR NW 13 HL 3/8	L	PN 315	15	15	R 3/8" K	12	21.0	34.0	28.0	19
XWR NW 16 HL	L	PN 315	18	18	R 1/2" K	14	23.5	36.0	31.0	24
XWR NW 16 HL 3/8	L	PN 315	18	18	R 3/8" K	12	23.5	36.0	31.0	24
XWR NW 16 HL 3/4	L	PN 315	18	18	R 3/4" K	16	27.5	42.0	35.0	27
XWRK NW 20 HL	L	PN 160	22	22	R 3/4" K	16	27.5	42.0	35.0	27
XWR NW 03 HS	S	PN 400	6	6	R 1/4" K	12	16.0	26.0	23.0	12
XWR NW 04 HS	S	PN 400	8	8	R 1/4" K	12	17.0	27.0	24.0	14
XWR NW 06 HS	S	PN 400	10	10	R 3/8" K	12	17.5	28.0	25.0	17
XWR NW 08 HS	S	PN 400	12	12	R 3/8" K	12	21.5	28.0	29.0	17
XWR NW 08 HS 1/2	S	PN 400	12	12	R 1/2" K	14	23.5	34.0	31.0	19
XWR NW 10 HS	S	PN 400	14	14	R 1/2" K	14	22.0	32.0	30.0	19
XWR NW 13 HS	S	PN 400	16	16	R 1/2" K	14	24.5	32.0	33.0	24
XWR NW 16 HS 1/2	S	PN 400	20	20	R 1/2" K	14	26.5	42.0	37.0	27
XWR NW 13 HS 3/8	S	PN 400	16	16	R 3/8" K	12	24.5	32.0	33.0	24

结构系列: LL=特轻系列 L=轻系列 S=重系列; G=接口螺纹

端直角管接头（英制圆柱管螺纹）

XWR

结构形式：90°角

连接1：BSP标准外螺纹

密封形式：B型

连接2：公制外螺纹

密封形式：24°内锥面密封

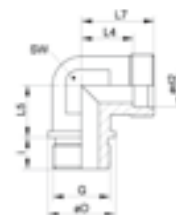

订货号	系列	工作压力 bar	Ød2 mm	管外径Ø mm	G	ØD mm	i mm	L4 mm	L5 mm	L7 mm	SW mm
XWR NW 20 HL	L	PN 160	22	22	G 3/4" -14	32	16	27.5	26	35	27
XWR NW 25 HL	L	PN 160	28	28	G 1" -11	39	18	30.5	30	38	36
XWR NW 32 HL	L	PN 160	35	35	G 1.1/4" -11	49	20	34.5	34	45	41
XWR NW 40 HL	L	PN 160	42	42	G 1.1/2" -11	55	22	40.0	39	51	50
XWR NW 16 HS	S	PN 160	20	20	G 3/4" -14	32	16	26.5	26	32	27
XWR NW 20 HS	S	PN 160	25	25	G 1" -11	39	18	30.0	30	42	36
XWR NW 25 HS	S	PN 160	30	30	G 1.1/4" -11	49	20	35.5	34	49	41
XWR NW 32 HS	S	PN 160	38	38	G 1.1/2" -11	55	22	41.0	39	57	50

结构系列：LL=特轻系列 L=轻系列 S=重系列；G=接口螺纹

端直角管接头（公制锥管螺纹）

XWMK

结构形式：90°角

连接1：公制锥管外螺纹

密封形式：螺纹密封

连接2：公制外螺纹

密封形式：24°内锥面密封

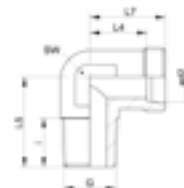

订货号	系列	工作压力 bar	Ød2 mm	管外径Ø mm	G	i mm	L4 mm	L5 mm	L7 mm	SW mm
XWM 04 LL	LL	PN 100	4	4	M 8 x 1 K	8.0	11.0	17	15	9
XWM 04 LL 6	LL	PN 100	4	4	M 6 x 1 K	8.0	11.0	17	15	9
XWM 05 LL	LL	PN 100	5	5	M 8 x 1 K	8.0	9.5	17	15	9
XWM 06 LL 6	LL	PN 100	6	6	M 6 x 1 K	7.0	9.5	17	15	9
XWM 06 LL 8	LL	PN 100	6	6	M 8 x 1 K	8.0	9.5	17	15	9
XWM 06 LL	LL	PN 100	6	6	M 10 x 1 K	9.0	9.5	17	15	9
XWM 08 LL	LL	PN 100	8	8	M 10 x 1 K	10.0	11.5	20	17	12
XWM NW 04 HL	L	PN 315	6	6	M 10 x 1 K	8.0	12.0	20	19	12
XWM NW 04 HL 12	L	PN 315	6	6	M 12 x 1.5 K	12.0	12.0	22	19	12
XWM NW 06 HL	L	PN 315	8	8	M 12 x 1.5 K	12.0	14.0	26	21	12
XWM NW 08 HL	L	PN 315	10	10	M 14 x 1.5 K	11.5	15.0	27	22	14
XWM NW 08 HL 16	L	PN 315	10	10	M 16 x 1.5 K	11.5	15.0	28	22	14
XWM NW 10 HL	L	PN 315	12	12	M 16 x 1.5 K	11.5	17.0	28	24	17
XWM NW 13 HL	L	PN 315	15	15	M 18 x 1.5 K	13.5	21.0	32	28	19
XWM NW 16 HL	L	PN 315	18	18	M 22 x 1.5 K	15.0	23.5	36	31	24
XWM NW 03 HS	S	PN 400	6	6	M 12 x 1.5 K	12.0	16.0	26	23	12
XWM NW 04 HS	S	PN 400	8	8	M 14 x 1.5 K	12.0	17.0	27	24	14
XWM NW 06 HS	S	PN 400	10	10	M 16 x 1.5 K	12.0	17.5	28	25	17
XWM NW 08 HS	S	PN 400	12	12	M 18 x 1.5 K	12.0	21.5	28	29	17
XWM NW 10 HS	S	PN 400	14	14	M 20 x 1.5 K	14.0	22.0	32	30	19
XWM NW 13 HS	S	PN 400	16	16	M 22 x 1.5 K	14.0	24.5	32	33	24

结构系列：LL=特轻系列 L=轻系列 S=重系列；G=接口螺纹

端直角管接头（公制圆柱管螺纹）

XWM

结构形式：90°角
 连接1：公制圆柱管螺纹
 密封形式：B型
 连接2：公制外螺纹
 密封形式：24°内锥面密封

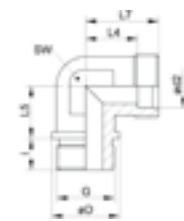

订货号	系列	工作压力 bar	Ød2 mm	管外径Ø mm	G	D mm	i mm	L4 mm	L5 mm	L7 mm	SW mm
XWM NW 20 HL	L	PN 160	22	22	M 26 x 1.5	31	16	27.5	26	35	27
XWM NW 25 HL	L	PN 160	28	28	M 33 x 2	39	18	30.5	30	38	36
XWM NW 32 HL	L	PN 160	35	35	M 42 x 2	49	20	34.5	34	45	41
XWM NW 40 HL	L	PN 160	42	42	M 48 x 2	55	22	40.0	39	51	50
XWM NW 16 HS	S	PN 400	20	20	M 27 x 2	32	16	26.5	26	37	27
XWM NW 20 HS	S	PN 250	25	25	M 33 x 2	39	18	30.0	30	42	36
XWM NW 25 HS	S	PN 160	30	30	M 42 x 2	49	20	35.5	34	49	41
XWM NW 32 HS	S	PN 160	38	38	M 48 x 2	55	22	41.0	39	57	50

系列：LL=特轻系列 L=轻系列 S=重系列；G=接口螺纹

端直角管接头（NPT螺纹）

XWN

结构形式：90°角
 连接1：NPT外螺纹
 密封形式：螺纹密封
 连接2：公制外螺纹
 密封形式：24°内锥面密封

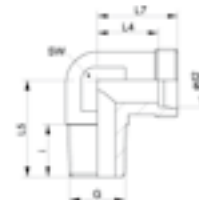

订货号	系列	工作压力 bar	Ød2 mm	管外径Ø mm	G	i mm	L4 mm	L5 mm	L7 mm	SW mm
XWN 04 LL	LL	PN 100	4	4	1/8" -27 NPT	8.0	11.0	17	15.0	9
XWN 05 LL	LL	PN 100	5	5	1/8" -27 NPT	8.0	11.0	17	15.0	9
XWN 06 LL	LL	PN 100	6	6	1/8" -27 NPT	8.0	9.5	17	15.0	9
XWN 08 LL	LL	PN 100	8	8	1/8" -27 NPT	10.0	11.5	20	17.0	12
XWN NW 04 HL	L	PN 315	6	6	1/8" -27 NPT	10.0	12.0	20	19.0	12
XWN NW 04 HL 1/4	L	PN 315	6	6	1/4" -18 NPT	12.0	14.0	26	21.0	12
XWN NW 04 HL 1/2	L	PN 315	6	6	1/2" -14 NPT	17.0	23.0	34	30.0	19
XWN NW 06 HL	L	PN 315	8	8	1/4" -18 NPT	12.0	14.0	26	21.0	12
XWN NW 06 HL 3/8	L	PN 315	8	8	3/8" -18 NPT	15.2	11.5	20	18.5	12
XWN NW 06 HL 1/2	L	PN 315	8	8	1/2" -14 NPT	17.5	15.0	26	22.0	12
XWN NW 08 HL	L	PN 315	10	10	1/4" -18 NPT	14.0	15.0	27	22.0	14
XWN NW 08 HL 3/8	L	PN 315	10	10	3/8" -18 NPT	15.2	15.0	27	22.0	14
XWN NW 10 HL	L	PN 315	12	12	3/8" -18 NPT	12.5	17.0	28	24.0	17
XWN NW 10 HL 1/4	L	PN 315	12	12	1/4" -18 NPT	14.0	17.0	28	24.0	17
XWN NW 10 HL 1/2	L	PN 315	12	12	1/2" -14 NPT	19.0	23.0	34	30.0	19
XWN NW 13 HL	L	PN 315	15	15	1/2" -14 NPT	18.5	21.0	34	28.0	19
XWN NW 13 HL 3/8	L	PN 315	15	15	3/8" -18 NPT	13.0	21.0	34	28.0	19
XWN NW 16 HL	L	PN 315	18	18	1/2" -14 NPT	20.0	23.5	36	31.0	24
XWN NW 16 HL 3/4	L	PN 315	18	18	3/4" -14 NPT	18.5	23.5	40	31.0	24
XWN NW 20 HL	L	PN 160	22	22	3/4" -14 NPT	18.5	27.5	42	35.0	27
XWN NW 25 HL	L	PN 160	28	28	1" -11.5 NPT	24.0	30.5	48	38.0	36
XWN NW 32 HL	L	PN 160	35	35	1.1/4" -11.5 NPT	25.5	34.5	54	45.0	41
XWN NW 40 HL	L	PN 160	42	42	1.1/2" -11.5 NPT	26.0	40.0	61	51.0	50
XWN NW 03 HS	S	PN 630	6	6	1/4" -18 NPT	12.0	16.0	26	23.0	12
XWN NW 04 HS	S	PN 630	8	8	1/4" -18 NPT	15.0	17.0	27	24.0	14
XWN NW 06 HS	S	PN 630	10	10	3/8" -18 NPT	12.0	17.5	28	25.0	17
XWN NW 08 HS	S	PN 630	12	12	3/8" -18 NPT	12.5	21.5	28	29.0	17
XWN NW 10 HS	S	PN 630	14	14	1/2" -14 NPT	18.0	22.0	34	30.0	19
XWN NW 13 HS	S	PN 400	16	16	1/2" -14 NPT	19.0	24.5	36	33.0	24
XWN NW 13 HS 3/4	S	PN 400	16	16	3/4" -14 NPT	20.0	24.5	40	33.0	24
XWN NW 16 HS	S	PN 400	20	20	3/4" -14 NPT	20.0	26.6	42	37.0	27
XWN NW 20 HS	S	PN 400	25	25	1" -11.5 NPT	24.0	30.0	48	42.0	36
XWN NW 25 HS	S	PN 400	30	30	1.1/4" -11.5 NPT	25.5	35.5	54	49.0	41
XWN NW 32 HS	S	PN 315	38	38	1.1/2" -11.5 NPT	26.0	41.0	61	57.0	50

结构系列：LL=特轻系列 L=轻系列 S=重系列；G=接口螺纹

L型端三通管接头（英制锥管螺纹）

XLRK

结构形式：L形

连接1：BSPT标准外螺纹

密封形式：螺纹密封

连接2：公制外螺纹

密封形式：24°内锥面密封

连接3：公制外螺纹

密封形式：24°内锥面密封



订货号	系列	工作压力 bar	Ød2 mm	管外径Ø mm	G	i mm	L4 mm	L5 mm	L7 mm	SW mm
XLR 04 LL	LL	PN 100	4	4	R 1/8" K	8	11.0	17	15	9
XLR 05 LL	LL	PN 100	5	5	R 1/8" K	8	9.5	17	15	9
XLR 06 LL	LL	PN 100	6	6	R 1/8" K	8	9.5	17	15	9
XLR 08 LL	LL	PN 100	8	8	R 1/8" K	8	11.5	20	17	12
XLR NW 04 HL	L	PN 315	6	6	R 1/8" K	8	12.0	20	19	12
XLR NW 06 HL	L	PN 315	8	8	R 1/4" K	12	14.0	26	21	12
XLR NW 08 HL	L	PN 315	10	10	R 1/4" K	12	15.0	27	22	14
XLR NW 10 HL	L	PN 315	12	12	R 3/8" K	12	17.0	28	24	17
XLR NW 13 HL	L	PN 315	15	15	R 1/2" K	14	21.0	34	26	19
XLR NW 16 HL	L	PN 315	18	18	R 1/2" K	14	23.5	36	31	24
XLR NW 03 HS	S	PN 400	6	6	R 1/4" K	12	16.0	26	23	14
XLR NW 04 HS	S	PN 400	8	8	R 1/4" K	12	17.0	27	24	17
XLR NW 06 HS	S	PN 400	10	10	R 3/8" K	12	17.5	28	25	17
XLR NW 08 HS	S	PN 400	12	12	R 3/8" K	12	21.5	28	29	19
XLR NW 10 HS	S	PN 400	14	14	R 1/2" K	14	22.0	32	30	19
XLR NW 13 HS	S	PN 400	16	16	R 1/2" K	14	24.5	32	33	24

系列：LL=特轻系列 L=轻系列 S=重系列；G=接口螺纹

L型端三通管接头（英制圆柱管螺纹）

XLR

结构形式：L形

连接1：BSP标准外螺纹

密封形式：B型

连接2：公制外螺纹

密封形式：24°内锥面密封

连接3：公制外螺纹

密封形式：24°内锥面密封

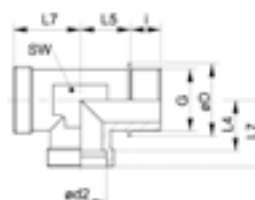

订货号	系列	工作压力 bar	Ød2 mm	G	管外径Ø mm	ØD mm	i mm	L4 mm	L5 mm	L7 mm	SW mm
XLR NW 20 HL	L	PN 160	22	G 3/4" -14	22	32	16	27.5	26	35	27
XLR NW 25 HL	L	PN 160	28	G 1" -11	28	39	18	30.5	30	38	36
XLR NW 32 HL	L	PN 160	35	G 1.1/4" -11	35	49	20	34.5	34	45	41
XLR NW 40 HL	L	PN 160	42	G 1.1/2" -11	42	55	22	40.0	39	51	50
XLR NW 16 HS	S	PN 400	20	G 3/4" -14	20	32	16	26.5	26	37	27
XLR NW 20 HS	S	PN 400	25	G 1" -11	25	39	18	30.0	30	42	36
XLR NW 25 HS	S	PN 250	30	G 1.1/4" -11	30	49	20	35.5	34	49	41
XLR NW 32 HS	S	PN 250	38	G 1.1/2" -11	38	55	22	41.0	39	57	50

系列：LL=特轻系列 L=轻系列 S=重系列；G=接口螺纹

L型端三通管接头（公制锥管螺纹）

XLMK

结构形式：L形

连接1：公制锥管螺纹

密封形式：螺纹密封

连接2：公制外螺纹

密封形式：24°内锥面密封

连接3：公制外螺纹

密封形式：24°内锥面密封

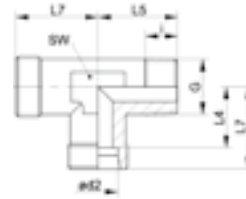

订货号	系列	工作压力 bar	Ød2 mm	管外径Ø mm	G	i mm	L4 mm	L5 mm	L7 mm	SW mm
XLM 04 LL	LL	PN 100	4	4	M 8 x 1 K	8	11.0	17	15	9
XLM 05 LL	LL	PN 100	5	5	M 8 x 1 K	8	9.5	17	15	11
XLM 06 LL	LL	PN 100	6	6	M 10 x 1 K	8	9.5	17	15	9
XLM 08 LL	LL	PN 100	8	8	M 10 x 1 K	8	11.5	20	17	12
XLM NW 04 HL	L	PN 315	6	6	M 10 x 1 K	8	12.0	20	19	12
XLM NW 06 HL	L	PN 315	8	8	M 12 x 1.5 K	12	14.0	26	21	12
XLM NW 08 HL	L	PN 315	10	10	M 14 x 1.5 K	12	15.0	27	22	14
XLM NW 10 HL	L	PN 315	12	12	M 16 x 1.5 K	12	17.0	28	24	17
XLM NW 13 HL	L	PN 316	15	15	M 18 x 1.5 K	12	21.0	32	26	19
XLM NW 16 HL	L	PN 315	18	18	M 22 x 1.5 K	14	23.5	36	31	24
XLM NW 03 HS	S	PN 400	6	6	M 12 x 1.5 K	12	16.0	26	23	12
XLM NW 04 HS	S	PN 400	8	8	M 14 x 1.5 K	12	17.0	27	24	14
XLM NW 06 HS	S	PN 400	10	10	M 16 x 1.5 K	12	17.5	28	25	17
XLM NW 08 HS	S	PN 400	12	12	M 18 x 1.5 K	12	21.5	28	29	17
XLM NW 10 HS	S	PN 400	14	14	M 20 x 1.5 K	14	22.0	32	30	19
XLM NW 13 HS	S	PN 400	16	16	M 22 x 1.5 K	14	24.5	32	33	24

系列： LL=特轻系列 L=轻系列 S=重系列； G=接口螺纹

L型端三通管接头（公制圆柱管螺纹）

XLM

结构形式：L形

连接1：公制圆柱管螺纹

密封形式：B型

连接2：公制外螺纹

密封形式：24°内锥面密封

连接3：公制外螺纹

密封形式：24°内锥面密封

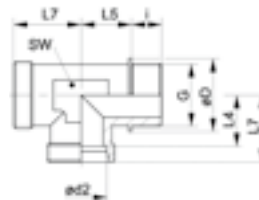

订货号	系列	工作压力 bar	Ød2 mm	管外径Ø mm	G	ØD mm	i mm	L4 mm	L5 mm	L7 mm	SW mm
XLM NW 20 HL	L	PN 160	22	22	M 26 x 1.5	31	16	27.5	26	35	27
XLM NW 25 HL	L	PN 160	28	28	M 33 x 2	39	18	30.5	30	38	36
XLM NW 32 HL	L	PN 160	35	35	M 42 x 2	49	20	34.5	34	45	41
XLM NW 40 HL	L	PN 160	42	42	M 48 x 2	55	22	40.0	39	51	50
XLM NW 16 HS	S	PN 400	20	20	M 27 x 2	32	16	26.5	26	37	27
XLM NW 20 HS	S	PN 400	25	25	M 33 x 2	39	18	30.0	30	42	36
XLM NW 25 HS	S	PN 250	30	30	M 42 x 2	49	20	35.5	34	49	41
XLM NW 32 HS	S	PN 250	38	38	M 48 x 2	55	22	41.0	39	57	50

系列： LL=特轻系列 L=轻系列 S=重系列； G=接口螺纹

L型端三通管接头 (NPT螺纹)

XLN

结构形式: L形

连接1: NPT外螺纹

密封形式: 螺纹密封

连接2: 公制外螺纹

密封形式: 24°内锥面密封

连接3: 公制外螺纹

密封形式: 24°内锥面密封



订货号	系列	工作压力 bar	Ød2 mm	管外径Ø mm	G	i mm	L4 mm	L5 mm	L7 mm	SW mm
XLN 04 LL	LL	PN 100	4	4	1/8" -27 NPT	8	11.0	17	15	9
XLN 06 LL	LL	PN 100	6	6	1/8" -27 NPT	8	9.5	17	15	9
XLN 08 LL	LL	PN 100	8	8	1/8" -27 NPT	8	11.5	20	17	12
XLN NW 04 HL	L	PN 315	6	6	1/8" -27 NPT	8	12.0	20	19	12
XLN NW 06 HL	L	PN 315	8	8	1/4" -18 NPT	12	14.0	26	21	12
XLN NW 08 HL	L	PN 315	10	10	1/4" -18 NPT	12	15.0	27	22	14
XLN NW 10 HL	L	PN 315	12	12	3/8" -18 NPT	12	17.0	28	24	17
XLN NW 13 HL	L	PN 315	15	15	1/2" -14 NPT	14	21.0	34	28	19
XLN NW 16 HL	L	PN 315	18	18	1/2" -14 NPT	14	23.5	36	31	24
XLN NW 20 HL	L	PN 160	22	22	3/4" -14 NPT	16	27.5	42	35	27
XLN NW 25 HL	L	PN 160	28	28	1" -11.5 NPT	18	30.5	48	38	36
XLN NW 32 HL	L	PN 160	35	35	1.1/4" -11.5 NPT	20	34.5	54	45	41
XLN NW 40 HL	L	PN 160	42	42	1.1/2" -11.5 NPT	22	40.0	61	51	50
XLN NW 03 HS	S	PN 630	6	6	1/4" -18 NPT	12	16.0	26	23	12
XLN NW 04 HS	S	PN 630	8	8	1/4" -18 NPT	12	17.0	27	24	14
XLN NW 06 HS	S	PN 630	10	10	3/8" -18 NPT	12	17.5	28	25	17
XLN NW 08 HS	S	PN 630	12	12	3/8" -18 NPT	12	21.5	31	29	17
XLN NW 10 HS	S	PN 630	14	14	1/2" -14 NPT	14	22.0	32	30	19
XLN NW 13 HS	S	PN 400	16	16	1/2" -14 NPT	14	24.5	32	33	24
XLN NW 16 HS	S	PN 400	20	20	3/4" -14 NPT	16	26.5	42	37	27
XLN NW 20 HS	S	PN 400	25	25	1" -11.5 NPT	18	30.0	48	42	36
XLN NW 25 HS	S	PN 400	30	30	1.1/4" -11.5 NPT	20	35.5	54	49	41
XLN NW 32 HS	S	PN 315	38	38	1.1/2" -11.5 NPT	22	41.0	61	57	50

系列: LL=特轻系列 L=轻系列 S=重系列; G=接口螺纹

T型端三通管接头 (英制锥管螺纹)

XTRK

结构形式: T形

连接1: BSPT标准外螺纹

密封形式: 螺纹密封

连接2: 公制外螺纹

密封形式: 24°内锥面密封

连接3: 公制外螺纹

密封形式: 24°内锥面密封



订货号	系列	工作压力 bar	Ød2 mm	管外径Ø mm	G	i mm	L4 mm	L5 mm	L7 mm	SW mm
XTR 04 LL	LL	PN 100	4	4	R 1/8" K	8	11.0	17	15	9
XTR 05 LL	LL	PN 100	5	5	R 1/8" K	8	9.5	17	15	9
XTR 06 LL	LL	PN 100	6	6	R 1/8" K	8	9.5	17	15	9
XTR 08 LL	LL	PN 100	8	8	R 1/8" K	8	11.5	20	17	12
XTR 10 LL	LL	PN 100	10	10	R 1/4" K	12	12.5	23	16	14
XTR 12 LL	LL	PN 100	12	12	R 1/4" K	12	13.0	23	17	17
XTR NW 04 HL	L	PN 315	6	6	R 1/8" K	8	12.0	20	19	12
XTR NW 06 HL	L	PN 315	8	8	R 1/4" K	12	14.0	26	21	12
XTR NW 08 HL	L	PN 315	10	10	R 1/4" K	12	15.0	27	22	14
XTR NW 10 HL	L	PN 315	12	12	R 3/8" K	12	17.0	28	24	17
XTR NW 13 HL	L	PN 315	15	15	R 1/2" K	14	21.0	34	28	19
XTR NW 16 HL	L	PN 315	18	18	R 1/2" K	14	23.5	34	31	24
XTR NW 03 HS	S	PN 400	6	6	R 1/4" K	12	16.0	26	23	12
XTR NW 04 HS	S	PN 400	8	8	R 1/4" K	12	17.0	26	24	14
XTR NW 06 HS	S	PN 400	10	10	R 3/8" K	12	17.5	27	25	17
XTR NW 08 HS	S	PN 400	12	12	R 3/8" K	12	21.5	28	29	19
XTR NW 10 HS	S	PN 400	14	14	R 1/2" K	14	22.0	32	30	19
XTR NW 13 HS	S	PN 400	16	16	R 1/2" K	14	24.5	32	33	24

系列: LL=特轻系列 L=轻系列 S=重系列, G=接口螺纹

T型端三通管接头（英制圆柱管螺纹）

XTR

结构形式：T形
 连接1：BSP标准外螺纹
 密封形式：B型
 连接2：公制外螺纹
 密封形式：24°内锥面密封
 连接3：公制外螺纹
 密封形式：24°内锥面密封



订货号	系列	工作压力 bar	Ød2 mm	G1	管外径 mm	ØD mm	i mm	L1 mm	L2 mm	L7 mm	SW mm
XTR NW 20 HL	L	PN 160	22	G 3/4" -14	22	31	16	26	27.5	35	27
XTR NW 25 HL	L	PN 160	28	G 1" -11	28	39	18	30	30.5	38	36
XTR NW 32 HL	L	PN 160	35	G 1.1/4" -11	35	49	20	34	34.5	45	41
XTR NW 40 HL	L	PN 160	42	G 1.1/2" -11	42	55	22	39	40.0	51	50
XTR NW 16 HS	S	PN 400	20	G 3/4" -14	20	32	16	26	26.5	37	27
XTR NW 20 HS	S	PN 250	25	G 1" -11	25	39	18	30	30.0	42	36
XTR NW 25 HS	S	PN 160	30	G 1.1/4" -11	30	49	20	34	35.5	49	41
XTR NW 32 HS	S	PN 160	38	G 1.1/2" -11	38	55	22	39	41.0	57	50

系列：LL=特轻系列 L=轻系列 S=重系列；G1=接口螺纹

T型端三通管接头（公制锥管螺纹）

XTMK

结构形式：T形
 连接1：公制锥管外螺纹
 密封形式：螺纹密封
 连接2：公制外螺纹
 密封形式：24°内锥面密封
 连接3：公制外螺纹
 密封形式：24°内锥面密封



订货号	系列	工作压力 bar	Ød2 mm	管外径 mm	G	i mm	L4 mm	L5 mm	L7 mm	SW mm
XTM 04 LL	LL	PN 100	4	4	M 8 x 1 K	8	11.0	17	15	9
XTM 05 LL	LL	PN 100	5	5	M 8 x 1 K	8	9.5	17	15	9
XTM 06 LL	LL	PN 100	6	6	M 10 x 1 K	8	9.5	17	15	9
XTM 08 LL	LL	PN 100	8	8	M 10 x 1 K	8	11.5	20	17	12
XTM NW 04 HL	L	PN 315	6	6	M 10 x 1 K	8	12.0	20	19	12
XTM NW 06 HL	L	PN 315	8	8	M 12 x 1.5 K	12	14.0	26	21	12
XTM NW 08 HL	L	PN 315	10	10	M 14 x 1.5 K	12	15.0	27	22	14
XTM NW 10 HL	L	PN 315	12	12	M 16 x 1.5 K	12	17.0	28	24	17
XTM NW 13 HL	L	PN 315	15	15	M 18 x 1.5 K	12	21.0	32	28	19
XTM NW 16 HL	L	PN 315	18	18	M 22 x 1.5 K	14	23.5	34	31	24
XTM NW 03 HS	S	PN 400	6	6	M 12 x 1.5 K	12	16.0	26	23	12
XTM NW 04 HS	S	PN 400	8	8	M 14 x 1.5 K	12	17.0	26	24	14
XTM NW 06 HS	S	PN 400	10	10	M 16 x 1.5 K	12	17.5	27	25	17
XTM NW 08 HS	S	PN 400	12	12	M 18 x 1.5 K	12	21.5	28	29	19
XTM NW 10 HS	S	PN 400	14	14	M 20 x 1.5 K	14	22.0	32	30	19
XTM NW 13 HS	S	PN 400	16	16	M 22 x 1.5 K	14	24.5	32	33	24

系列：LL=特轻系列 L=轻系列 S=重系列；G=接口螺纹

T型端三通管接头（公制圆柱管螺纹）

XTM

结构形式：T形
 连接1：公制圆柱管螺纹
 密封形式：B型
 连接2：公制外螺纹
 密封形式：24°内锥面密封
 连接3：公制外螺纹
 密封形式：24°内锥面密封



订货号	系列	工作压力 bar	Ød2 mm	管外径 mm	G	ØD mm	i mm	L1 mm	L2 mm	L7 mm	SW mm
XTM NW 20 HL	L	PN 160	22	22	M 26 x 1.5	31	16	26	27.5	35	27
XTM NW 25 HL	L	PN 160	28	28	M 33 x 2	39	18	30	30.5	38	36
XTM NW 32 HL	L	PN 160	35	35	M 42 x 2	49	20	34	34.5	45	41
XTM NW 40 HL	L	PN 160	42	42	M 48 x 2	55	22	39	41.0	51	50
XTM NW 16 HS	S	PN 400	20	20	M 27 x 2	32	16	26	26.5	39	27
XTM NW 20 HS	S	PN 250	25	25	M 33 x 2	39	18	30	30.0	42	36
XTM NW 25 HS	S	PN 160	30	30	M 42 x 2	49	20	34	35.5	49	41
XTM NW 32 HS	S	PN 160	38	38	M 48 x 2	55	22	39	41.0	57	50

系列：LL=特轻系列 L=轻系列 S=重系列；G=接口螺纹

T型端三通管接头 (NPT螺纹)

XTN

结构形式: T形

连接1: NPT外螺纹

密封形式: 螺纹密封

连接2: 公制外螺纹

密封形式: 24°内锥面密封

连接3: 公制外螺纹

密封形式: 24°内锥面密封

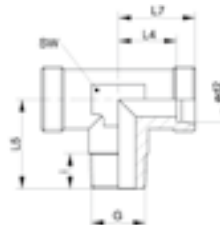

订货号	系列	工作压力 bar	Ød2 mm	G	管外径Ø mm	i mm	L4 mm	L5 mm	L7 mm	SW mm
XTN 04 LL	LL	PN 100	4	1/8" -27 NPT	4	8	11.0	17	15	9
XTN 05 LL	LL	PN 100	5	1/8" -27 NPT	5	8	9.5	17	15	9
XTN 06 LL	LL	PN 100	6	1/8" -27 NPT	6	8	9.5	17	15	9
XTN 08 LL	LL	PN 100	8	1/8" -27 NPT	8	8	11.5	20	17	12
XTN NW 04 HL	L	PN 315	6	1/8" -27 NPT	6	8	12.0	20	19	12
XTN NW 04 HL 1/4	L	PN 315	6	1/4" -18 NPT	6	12	12.0	25	19	12
XTN NW 06 HL	L	PN 315	8	1/4" -18 NPT	8	12	14.0	26	21	12
XTN NW 08 HL	L	PN 315	10	1/4" -18 NPT	10	12	15.0	27	22	14
XTN NW 10 HL	L	PN 315	12	3/8" -18 NPT	12	12	17.0	28	24	17
XTN NW 13 HL	L	PN 315	15	1/2" -14 NPT	15	14	21.0	34	26	19
XTN NW 16 HL	L	PN 315	18	1/2" -14 NPT	18	14	23.5	36	31	24
XTN NW 20 HL	L	PN 160	22	3/4" -14 NPT	22	16	27.5	42	35	27
XTN NW 25 HL	L	PN 160	28	1" -11.5 NPT	28	18	30.5	48	38	36
XTN NW 32 HL	L	PN 160	35	1.1/4" -11.5 NPT	35	20	34.5	54	45	41
XTN NW 40 HL	L	PN 160	42	1.1/2" -11.5 NPT	42	22	40.0	61	51	50
XTN NW 03 HS	S	PN 630	6	1/4" -18 NPT	6	12	16.0	26	23	12
XTN NW 04 HS	S	PN 630	8	1/4" -18 NPT	8	12	17.0	27	24	14
XTN NW 06 HS	S	PN 630	10	3/8" -18 NPT	10	12	17.5	28	35	17
XTN NW 08 HS	S	PN 630	12	3/8" -18 NPT	12	12	21.5	31	30	17
XTN NW 10 HS	S	PN 630	14	1/2" -14 NPT	14	14	22.0	32	30	19
XTN NW 13 HS	S	PN 400	16	1/2" -14 NPT	16	14	24.5	32	33	24
XTN NW 16 HS	S	PN 400	20	3/4" -14 NPT	20	16	26.5	42	37	27
XTN NW 20 HS	S	PN 400	25	1" -11.5 NPT	25	18	30.0	48	42	36
XTN NW 25 HS	S	PN 400	30	1.1/4" -11.5 NPT	30	20	35.5	54	49	41
XTN NW 32 HS	S	PN 315	38	1.1/2" -11.5 NPT	38	22	41.0	61	57	50

系列: LL=特轻系列 L=轻系列 S=重系列; G=接口螺纹

24°锥可调式端直通(英制圆柱管螺纹)

AOVR-ED

结构形式: 端直通

连接1: 活动端公制螺母

密封形式: 24°锥带O形圈密封

连接2: BSP标准外螺纹

密封形式: E型

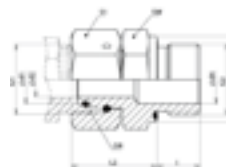

订货号	系列	工作压力 bar	Ød1 mm	G1	G2	Ød3 mm	i mm	L2 mm	SW mm	S1	OR	Ød2 mm
AOVR NW 04 L ED	L	PN 315	6	M 12 x 1.5	G 1/8" -28	13.9	8	24.5	14	14	4.0 x 1.5	-
AOVR NW 06 L ED	L	PN 315	8	M 14 x 1.5	G 1/4" -19	18.9	12	29.5	19	17	6.0 x 1.5	4
AOVR NW 08 L ED	L	PN 315	10	M 16 x 1.5	G 1/4" -19	18.9	12	27.5	19	19	7.5 x 1.5	6
AOVR NW 10 L 1/4 ED	L	PN 315	12	M 18 x 1.5	G 1/4" -19	18.9	12	30.0	19	22	9.0 x 1.5	6
AOVR NW 10 L 1/2 ED	L	PN 315	12	M 18 x 1.5	G 1/2" -14	26.9	14	34.0	27	22	9.0 x 1.5	8
AOVR NW 10 L ED	L	PN 315	12	M 18 x 1.5	G 3/8" -19	21.9	12	34.0	22	22	9.0 x 1.5	8
AOVR NW 13 L ED	L	PN 315	15	M 22 x 1.5	G 1/2" -14	26.9	14	32.0	27	27	12.0 x 2.0	10
AOVR NW 16 L ED	L	PN 315	18	M 26 x 1.5	G 1/2" -14	26.9	14	31.5	27	32	15.0 x 2.0	13
AOVR NW 20 L ED	L	PN 160	22	M 30 x 2	G 3/4" -14	31.9	16	32.5	32	36	20.0 x 2.0	17
AOVR NW 25 L ED	L	PN 160	28	M 36 x 2	G 1" -11	39.9	18	35.0	41	41	26.0 x 2.0	22
AOVR NW 32 L ED	L	PN 160	35	M 45 x 2	G 1.1/4" -11	49.9	20	42.5	50	50	32.0 x 2.5	28
AOVR NW 40 L ED	L	PN 160	42	M 52 x 2	G 1.1/2" -11	54.9	22	46.5	55	60	38.0 x 2.5	34
AOVR NW 03 S ED	S	PN 630	6	M 14 x 1.5	G 1/4" -19	18.9	12	27.0	19	17	4.0 x 1.5	2.5
AOVR NW 04 S ED	S	PN 630	8	M 16 x 1.5	G 1/4" -19	18.9	12	29.5	19	19	6.0 x 1.5	4
AOVR NW 06 S ED	S	PN 630	10	M 18 x 1.5	G 3/8" -19	21.9	12	32.0	22	22	7.5 x 1.5	6
AOVR NW 08 S 1/2 ED	S	PN 630	12	M 20 x 1.5	G 1/2" -14	26.9	14	35.0	27	24	9.0 x 1.5	8
AOVR NW 08 S ED	S	PN 630	12	M 20 x 1.5	G 3/8" -19	21.9	12	34.0	22	24	9.0 x 1.5	8
AOVR NW 10 S ED	S	PN 630	14	M 22 x 1.5	G 1/2" -14	26.9	14	36.5	27	27	10.0 x 2.0	9
AOVR NW 13 S ED	S	PN 400	16	M 24 x 1.5	G 1/2" -14	26.9	14	37.0	27	30	12.0 x 2.0	11
AOVR NW 16 S ED	S	PN 400	20	M 30 x 2	G 3/4" -14	31.9	16	43.0	32	36	16.3 x 2.4	14
AOVR NW 20 S ED	S	PN 400	25	M 36 x 2	G 1" -11	39.9	18	48.0	41	46	20.3 x 2.4	18
AOVR NW 25 S ED	S	PN 400	30	M 42 x 2	G 1.1/4" -11	49.9	20	51.0	50	50	25.3 x 2.4	23
AOVR NW 32 S ED	S	PN 315	38	M 52 x 2	G 1.1/2" -11	54.9	22	60.0	55	60	33.3 x 2.4	30

系列: LL=特轻系列 L=轻系列 S=重系列; G1= 接口螺纹 G2= 接口螺纹

24°锥可调式端直通(英制圆柱管螺纹)

AOVR O

结构形式：端直通
 连接1：BSP标准外螺纹
 密封形式：G型
 连接2：活动端公制螺母
 密封形式：24°锥带O形圈密封

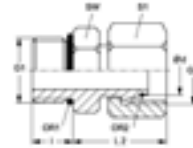

订货号	系列	工作压力 bar	Ød mm	G1	G2	i mm	L2 mm	SW mm	S1	OR1	OR2
AOVR O NW 03 S	S	PN 630	6	G 1/4" -19	M 14 x 1.5	12	26.0	19	17	9.30 x 2.30	4.0 x 1.5
AOVR O NW 04 S	S	PN 630	8	G 1/4" -19	M 16 x 1.5	12	28.0	19	19	11.30 x 2.30	6.0 x 1.5
AOVR O NW 06 S	S	PN 630	10	G 3/8" -19	M 18 x 1.5	12	30.5	22	22	13.30 x 2.30	7.5 x 1.5
AOVR O NW 08 S	S	PN 630	12	G 3/8" -19	M 20 x 1.5	12	32.5	22	24	15.30 x 2.30	9.0 x 1.5
AOVR O NW 10 S	S	PN 630	14	G 1/2" -14	M 22 x 1.5	14	36.0	27	27	17.86 x 2.62	10.0 x 2.0
AOVR O NW 13 S	S	PN 400	16	G 1/2" -14	M 24 x 1.5	14	36.5	27	30	12.00 x 2.00	12.0 x 2.0
AOVR O NW 16 S	S	PN 400	20	G 3/4" -14	M 30 x 2	16	40.5	32	36	23.50 x 3.00	16.3 x 2.4
AOVR O NW 20 S	S	PN 400	25	G 1" -11	M 36 x 2	18	46.0	41	46	29.50 x 3.00	20.3 x 2.4
AOVR O NW 25 S	S	PN 250	30	G 1.1/4" -11	M 42 x 2	20	48.0	50	50	38.00 x 3.00	25.3 x 2.4
AOVR O NW 32 S	S	PN 250	38	G 1.1/2" -11	M 52 x 2	22	55.0	55	55	44.04 x 3.53	33.3 x 2.4

系列： LL=特轻系列 L=轻系列 S=重系列； G1= 接口螺纹 G2= 接口螺纹

24°锥可调式端直通(英制圆柱管螺纹)

AOVR OK

结构形式：端直通
 连接1：BSP标准外螺纹
 密封形式：O形圈和支承环“H型”
 连接2：活动端公制螺母
 密封形式：24°锥带O形圈密封

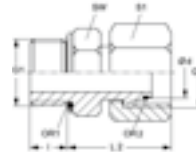

订货号	系列	工作压力 bar	Ød mm	G1	G2	i mm	L2 mm	SW mm	S1	OR1	OR2
AOVR OK NW 03 S	S	PN 630	6	G 1/4" -19	M 14 x 1.5	10.5	27.5	19	17	9.30 x 2.30	4.0 x 1.5
AOVR OK NW 04 S	S	PN 630	8	G 1/4" -19	M 16 x 1.5	10.5	29.5	19	19	11.30 x 2.30	6.0 x 1.5
AOVR OK NW 06 S	S	PN 630	10	G 3/8" -19	M 18 x 1.5	10.5	32.0	22	22	13.30 x 2.30	7.5 x 1.5
AOVR OK NW 08 S	S	PN 630	12	G 3/8" -19	M 20 x 1.5	10.5	34.0	22	24	15.30 x 2.30	9.0 x 1.5
AOVR OK NW 10 S	S	PN 630	14	G 1/2" -14	M 22 x 1.5	12.0	38.0	27	27	17.86 x 2.62	10.0 x 2.0
AOVR OK NW 13 S	S	PN 400	16	G 1/2" -14	M 24 x 1.5	12.0	38.5	27	30	12.00 x 2.00	12.0 x 2.0
AOVR OK NW 16 S	S	PN 400	20	G 3/4" -14	M 30 x 2	14.0	42.5	32	36	23.50 x 3.00	16.3 x 2.4
AOVR OK NW 20 S	S	PN 400	25	G 1" -11	M 36 x 2	15.5	48.5	41	46	29.50 x 3.00	20.3 x 2.4
AOVR OK NW 32 S	S	PN 250	38	G 1.1/2" -11	M 52 x 2	19.5	57.5	55	60	44.04 x 3.53	33.3 x 2.4

系列： LL=特轻系列 L=轻系列 S=重系列； G1= 接口螺纹 G2= 接口螺纹

24°锥可调式端直通(公制圆柱管螺纹)

AOVM-ED

结构形式: 端直通

连接1: 公制圆柱管外螺纹

密封形式: E型

连接2: 活动端公制螺母

密封形式: 24°锥带O形圈密封

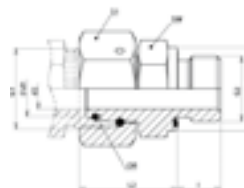

订货号	系列	工作压力 bar	Ød2 mm	Ød mm	Ød1 mm	G1	G2	Ød3 mm	i mm	L2 mm	SW mm	S1	OR
AOVM NW 04 L ED	L	PN 315	2.5	2.5	6	M 12 x 1.5	M 10 x 1	13.9	8	24.5	14	14	4.0 x 1.5
AOVM NW 06 L ED	L	PN 315	4.5	4.5	8	M 14 x 1.5	M 12 x 1.5	16.9	12	26.5	17	17	6.0 x 1.5
AOVM NW 08 L ED	L	PN 315	6	6	10	M 16 x 1.5	M 14 x 1.5	18.9	12	27.5	19	19	7.5 x 1.5
AOVM NW 10 L ED	L	PN 315	8	8	12	M 18 x 1.5	M 16 x 1.5	21.9	12	30.5	22	22	9.0 x 1.5
AOVM NW 13 L ED	L	PN 315	10	10	15	M 22 x 1.5	M 18 x 1.5	23.9	12	31.5	24	27	12.0 x 2.0
AOVM NW 16 L ED	L	PN 315	13	13	18	M 26 x 1.5	M 22 x 1.5	26.9	14	31.5	27	32	15.0 x 2.0
AOVM NW 20 L ED	L	PN 160	17	17	22	M 30 x 2	M 26 x 1.5	31.9	16	32.5	32	36	20.0 x 2.0
AOVM NW 25 L ED	L	PN 160	22	22	28	M 36 x 2	M 33 x 2	39.9	18	35.0	41	41	26.0 x 2.0
AOVM NW 32 L ED	L	PN 160	28	28	35	M 45 x 2	M 42 x 2	49.9	20	42.5	50	50	32.0 x 2.5
AOVM NW 40 L ED	L	PN 160	34	34	42	M 52 x 2	M 48 x 2	54.9	22	46.5	55	60	38.0 x 2.5
AOVM NW 03 S ED	S	PN 630	2.5	2.5	6	M 14 x 1.5	M 12 x 1.5	16.9	12	27.0	17	17	4.0 x 1.5
AOVM NW 04 S ED	S	PN 630	4	4	8	M 16 x 1.5	M 14 x 1.5	18.9	12	29.5	19	19	6.0 x 1.5
AOVM NW 06 S ED	S	PN 630	6	6	10	M 18 x 1.5	M 16 x 1.5	21.9	12	32.0	22	22	7.5 x 1.5
AOVM NW 08 S ED	S	PN 630	8	8	12	M 20 x 1.5	M 18 x 1.5	23.9	12	34.0	24	24	9.0 x 1.5
AOVM NW 10 S ED	S	PN 630	9	9	14	M 22 x 1.5	M 20 x 1.5	25.9	14	36.5	27	27	10.0 x 2.0
AOVM NW 13 S ED	S	PN 400	11	11	16	M 24 x 1.5	M 22 x 1.5	26.9	14	37.0	27	30	12.0 x 2.0
AOVM NW 16 S ED	S	PN 400	14	14	20	M 30 x 2	M 27 x 2	31.9	16	43.0	32	36	16.3 x 2.4
AOVM NW 20 S ED	S	PN 400	18	18	25	M 36 x 2	M 33 x 2	39.9	18	48.0	41	46	20.3 x 2.4
AOVM NW 25 S ED	S	PN 400	23	23	30	M 42 x 2	M 42 x 2	49.9	20	51.0	50	50	25.3 x 2.4
AOVM NW 32 S ED	S	PN 315	30	30	38	M 52 x 2	M 48 x 2	54.9	22	60.0	55	60	33.3 x 2.4

系列: LL=特轻系列 L=轻系列 S=重系列; G1= 接口螺纹 G2= 接口螺纹

24°锥可调式端直通(NPT螺纹)

AOVN

结构形式: 端直通

连接1: NPT标准外螺纹

密封形式: 螺纹密封

连接2: 活动端公制螺母

密封形式: 24°锥带O形圈密封

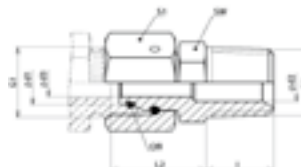

订货号	系列	工作压力 bar	Ød2 mm	Ød mm	Ød3 mm	Ød1 mm	G1	G2	i mm	L2 mm	SW mm	S1	OR
AOVN NW 04 L	L	PN 315	4.5	6	2.5	6	1/8" -27 NPT	M 12 x 1.5	10.0	31.5	11	14	4.0 x 1.5
AOVN NW 06 L	L	PN 315	6	8	4	8	1/4" -18 NPT	M 14 x 1.5	14.5	37.5	14	17	6.0 x 1.5
AOVN NW 08 L	L	PN 315	6	10	6	10	1/4" -18 NPT	M 16 x 1.5	14.5	38.0	14	19	7.5 x 1.5
AOVN NW 10 L	L	PN 315	8	12	8	12	3/8" -18 NPT	M 18 x 1.5	14.5	40.0	19	22	9.0 x 1.5
AOVN NW 13 L	L	PN 315	12	15	10	15	1/2" -14 NPT	M 22 x 1.5	19.5	49.5	22	27	12.0 x 2.0
AOVN NW 16 L	L	PN 315	12	18	12	18	1/2" -14 NPT	M 26 x 1.5	19.5	49.0	24	32	15.0 x 2.0
AOVN NW 20 L	L	PN 160	16.5	22	16.5	22	3/4" -14 NPT	M 30 x 2	19.5	52.0	27	36	20.0 x 2.0
AOVN NW 25 L	L	PN 160	21.5	28	21.5	28	1" -11.5 NPT	M 36 x 2	24.5	61.0	36	41	26.0 x 2.0
AOVN NW 32 L	L	PN 160	28	35	28	35	1.1/4" -11.5 NPT	M 45 x 2	25.0	65.5	46	50	32.0 x 2.5
AOVN NW 40 L	L	PN 160	34	42	34	42	1.1/2" -11.5 NPT	M 52 x 2	26.0	68.5	50	60	38.0 x 2.5
AOVN NW 03 S	S	PN 630	6	6	2.5	6	1/4" -18 NPT	M 14 x 1.5	14.5	37.5	14	17	4.0 x 1.5
AOVN NW 04 S	S	PN 630	6	8	4	8	1/4" -18 NPT	M 16 x 1.5	14.5	38.0	14	19	6.0 x 1.5
AOVN NW 06 S	S	PN 630	9	10	6	10	3/8" -18 NPT	M 18 x 1.5	14.5	40.5	19	22	7.5 x 1.5
AOVN NW 08 S	S	PN 630	8	12	8	12	3/8" -18 NPT	M 20 x 1.5	14.5	42.0	19	24	9.0 x 1.5
AOVN NW 10 S	S	PN 630	12	14	9	14	1/2" -14 NPT	M 22 x 1.5	19.5	50.5	22	27	10.0 x 2.0
AOVN NW 13 S	S	PN 400	11	16	11	16	1/2" -14 NPT	M 24 x 1.5	19.5	51.0	22	30	12.0 x 2.0
AOVN NW 16 S	S	PN 400	16.5	20	14	20	3/4" -14 NPT	M 30 x 2	19.5	54.0	27	36	16.3 x 2.4
AOVN NW 20 S	S	PN 400	21.5	25	18	25	1" -11.5 NPT	M 36 x 2	24.5	63.5	36	46	20.3 x 2.4
AOVN NW 25 S	S	PN 400	28.5	30	23	30	1.1/4" -11.5 NPT	M 42 x 2	25.0	70.5	46	50	25.3 x 2.4
AOVN NW 32 S	S	PN 315	35	38	30	38	1.1/2" -11.5 NPT	M 52 x 2	26.0	73.5	50	60	33.3 x 2.4

系列: LL=特轻系列 L=轻系列 S=重系列; G1= 接口螺纹 G2= 接口螺纹

24°锥可调式直通

XAOH

结构形式：直通

连接1：活动端公制螺母

密封形式：24°锥带O形圈密封

连接2：公制外螺纹

密封形式：24°内锥面密封

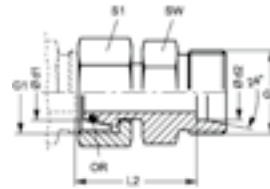

订货号	系列	工作压力 bar	Ød1 mm	Ød2 mm	G1	G2	L2 mm	SW mm	S1	OR
XAOH NW 04 LL 04	L / LL	PN 100	6	4	M 12 x 1.5	M 8 x 1	24.5	9	14	4.0 x 1.5
XAOH NW 04 L	L	PN 315	6	6	M 12 x 1.5	M 12 x 1.5	27.5	14	14	4.0 x 1.5
XAOH NW 04 L 06	L	PN 315	6	8	M 12 x 1.5	M 14 x 1.5	24.5	14	14	4.0 x 1.5
XAOH NW 04 L 08	L	PN 315	6	10	M 12 x 1.5	M 16 x 1.5	25.5	17	14	4.0 x 1.5
XAOH NW 04 L 10	L	PN 315	6	12	M 12 x 1.5	M 18 x 1.5	25.5	19	14	4.0 x 1.5
XAOH NW 04 L 13	L	PN 315	6	15	M 12 x 1.5	M 22 x 1.5	27.5	24	14	4.0 x 1.5
XAOH NW 06 L 04	L	PN 315	8	6	M 14 x 1.5	M 12 x 1.5	24.5	12	17	6.0 x 1.5
XAOH NW 06 L	L	PN 315	8	8	M 14 x 1.5	M 14 x 1.5	37	14	17	6.0 x 1.5
XAOH NW 06 L 08	L	PN 315	8	10	M 14 x 1.5	M 16 x 1.5	26	17	17	6.0 x 1.5
XAOH NW 06 L 10	L	PN 315	8	12	M 14 x 1.5	M 18 x 1.5	27	19	17	6.0 x 1.5
XAOH NW 06 L 13	L	PN 315	8	15	M 14 x 1.5	M 22 x 1.5	28	24	17	4.0 x 1.5
XAOH NW 08 L 04	L	PN 315	10	6	M 16 x 1.5	M 12 x 1.5	25	14	19	7.5 x 1.5
XAOH NW 08 L 06	L	PN 315	10	8	M 16 x 1.5	M 14 x 1.5	25	14	19	7.5 x 1.5
XAOH NW 08 L	L	PN 315	10	10	M 16 x 1.5	M 16 x 1.5	37	17	19	7.5 x 1.5
XAOH NW 08 L 10	L	PN 315	10	12	M 16 x 1.5	M 18 x 1.5	28	19	19	7.5 x 1.5
XAOH NW 08 L 13	L	PN 315	10	15	M 16 x 1.5	M 22 x 1.5	29	24	19	7.5 x 1.5
XAOH NW 08 L 16	L	PN 315	10	18	M 16 x 1.5	M 26 x 1.5	33	27	24	7.5 x 1.5
XAOH NW 10 L 04	L	PN 315	12	6	M 18 x 1.5	M 12 x 1.5	26.5	17	22	9.0 x 1.5
XAOH NW 10 L 06	L	PN 315	12	8	M 18 x 1.5	M 14 x 1.5	26.5	17	22	9.0 x 1.5
XAOH NW 10 L 08	L	PN 315	12	10	M 18 x 1.5	M 16 x 1.5	27.5	17	22	9.0 x 1.5
XAOH NW 10 L	L	PN 315	12	12	M 18 x 1.5	M 18 x 1.5	37	19	22	9.0 x 1.5
XAOH NW 10 L 13	L	PN 315	12	15	M 18 x 1.5	M 22 x 1.5	29	24	22	9.0 x 1.5
XAOH NW 10 L 16	L	PN 315	12	18	M 18 x 1.5	M 26 x 1.5	29.5	27	22	9.0 x 1.5
XAOH NW 13 L 04	L	PN 315	15	6	M 22 x 1.5	M 12 x 1.5	28.5	19	27	12.0 x 2.0
XAOH NW 13 L 06	L	PN 315	15	8	M 22 x 1.5	M 14 x 1.5	28.5	19	27	12.0 x 2.0
XAOH NW 13 L 08	L	PN 315	15	10	M 22 x 1.5	M 16 x 1.5	29.5	19	27	12.0 x 2.0
XAOH NW 13 L 10	L	PN 315	15	12	M 22 x 1.5	M 18 x 1.5	29.5	19	27	12.0 x 2.0
XAOH NW 13 L	L	PN 315	15	15	M 22 x 1.5	M 22 x 1.5	37	24	27	12.0 x 2.0
XAOH NW 13 L 16	L	PN 315	15	18	M 22 x 1.5	M 26 x 1.5	31.5	27	27	12.0 x 2.0
XAOH NW 13 L 20	L	PN 160	15	22	M 22 x 1.5	M 30 x 2	33.5	32	27	12.0 x 2.0
XAOH NW 16 L 04	L	PN 315	18	6	M 26 x 1.5	M 12 x 1.5	29.5	24	32	15.0 x 2.0
XAOH NW 16 L 06	L	PN 315	18	8	M 26 x 1.5	M 14 x 1.5	29.5	24	32	15.0 x 2.0
XAOH NW 16 L 08	L	PN 315	18	10	M 26 x 1.5	M 16 x 1.5	30.5	24	32	15.0 x 2.0
XAOH NW 16 L 10	L	PN 315	18	12	M 26 x 1.5	M 18 x 1.5	30.5	24	32	15.0 x 2.0
XAOH NW 16 L 13	L	PN 315	18	15	M 26 x 1.5	M 22 x 1.5	31.5	24	32	15.0 x 2.0
XAOH NW 16 L	L	PN 315	18	18	M 26 x 1.5	M 26 x 1.5	36	27	32	15.0 x 2.0
XAOH NW 16 L 20	L	PN 160	18	22	M 26 x 1.5	M 30 x 2	33	32	32	15.0 x 2.0
XAOH NW 16 L 25	L	PN 160	18	28	M 26 x 1.5	M 36 x 2	34	41	32	15.0 x 2.0
XAOH NW 20 L 04	L	PN 160	22	6	M 30 x 2	M 12 x 1.5	32	27	36	20.0 x 2.0
XAOH NW 20 L 06	L	PN 160	22	8	M 30 x 2	M 14 x 1.5	32	27	36	20.0 x 2.0
XAOH NW 20 L 08	L	PN 160	22	10	M 30 x 2	M 16 x 1.5	33.0	27	36	20.0 x 2.0
XAOH NW 20 L 10	L	PN 160	22	12	M 30 x 2	M 18 x 1.5	33	27	36	20.0 x 2.0
XAOH NW 20 L 13	L	PN 160	22	15	M 30 x 2	M 22 x 1.5	34	27	36	20.0 x 2.0
XAOH NW 20 L 16	L	PN 160	22	18	M 30 x 2	M 26 x 1.5	33.5	27	36	20.0 x 2.0
XAOH NW 20 L	L	PN 160	22	22	M 30 x 2	M 30 x 2	42.5	32	36	20.0 x 2.0
XAOH NW 20 L 25	L	PN 160	22	28	M 30 x 2	M 36 x 2	38	41	36	20.0 x 2.0
XAOH NW 20 L 32	L	PN 160	22	35	M 30 x 2	M 45 x 2	39	46	36	20.0 x 2.0
XAOH NW 25 L 04	L	PN 160	28	6	M 36 x 2	M 12 x 1.5	34	32	41	26.0 x 2.0
XAOH NW 25 L 06	L	PN 160	28	8	M 36 x 2	M 14 x 1.5	34	32	41	26.0 x 2.0
XAOH NW 25 L 08	L	PN 160	28	10	M 36 x 2	M 16 x 1.5	35	32	41	26.0 x 2.0
XAOH NW 25 L 10	L	PN 160	28	12	M 36 x 2	M 18 x 1.5	35	32	41	26.0 x 2.0
XAOH NW 25 L 13	L	PN 160	28	15	M 36 x 2	M 22 x 1.5	36	32	41	26.0 x 2.0
XAOH NW 25 L 16	L	PN 160	28	18	M 36 x 2	M 26 x 1.5	35.5	32	41	26.0 x 2.0
XAOH NW 25 L 20	L	PN 160	28	22	M 36 x 2	M 30 x 2	37.5	32	41	26.0 x 2.0
XAOH NW 25 L	L	PN 160	28	28	M 36 x 2	M 36 x 2	41.5	41	41	26.0 x 2.0
XAOH NW 25 L 32	L	PN 160	28	35	M 36 x 2	M 45 x 2	39.5	46	41	26.0 x 2.0
XAOH NW 25 L 40	L	PN 160	28	42	M 36 x 2	M 52 x 2	41	55	41	26.0 x 2.0
XAOH NW 32 L 04	L	PN 160	35	6	M 45 x 2	M 12 x 1.5	37	41	50	32.0 x 2.5
XAOH NW 32 L 06	L	PN 160	35	8	M 45 x 2	M 14 x 1.5	37	41	50	32.0 x 2.5

24°锥可调式直通

XAOH

结构形式：直通

连接1：活动端公制螺母

密封形式：24°锥带O形圈密封

连接2：公制外螺纹

密封形式：24°内锥面密封

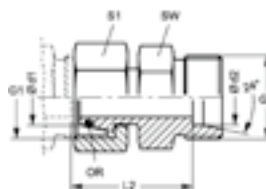

订货号	系列	工作压力 bar	Ød1 mm	Ød2 mm	G1	G2	L2 mm	SW mm	S1	OR
XAOH NW 32 L 08	L	PN 160	35	10	M 45 x 2	M 16 x 1.5	38	41	50	32.0 x 2.5
XAOH NW 32 L 10	L	PN 160	35	12	M 45 x 2	M 18 x 1.5	38	41	50	32.0 x 2.5
XAOH NW 32 L 13	L	PN 160	35	15	M 45 x 2	M 22 x 1.5	39.5	41	50	32.0 x 2.5
XAOH NW 32 L 16	L	PN 160	35	18	M 45 x 2	M 26 x 1.5	39.5	41	50	32.0 x 2.5
XAOH NW 32 L 20	L	PN 160	35	22	M 45 x 2	M 30 x 2	41.5	41	50	32.0 x 2.5
XAOH NW 32 L 25	L	PN 160	35	28	M 45 x 2	M 36 x 2	41.5	41	50	32.0 x 2.5
XAOH NW 32 L	L	PN 160	35	35	M 45 x 2	M 45 x 2	50	46	50	32.0 x 2.5
XAOH NW 32 L 40	L	PN 160	35	42	M 45 x 2	M 52 x 2	42	55	50	32.0 x 2.5
XAOH NW 40 L 04	L	PN 160	42	6	M 52 x 2	M 12 x 1.5	40.5	50	60	38.0 x 2.5
XAOH NW 40 L 06	L	PN 160	42	8	M 52 x 2	M 14 x 1.5	40.5	50	60	38.0 x 2.5
XAOH NW 40 L 08	L	PN 160	42	10	M 52 x 2	M 16 x 1.5	41.5	50	60	38.0 x 2.5
XAOH NW 40 L 10	L	PN 160	42	12	M 52 x 2	M 18 x 1.5	41.5	50	60	38.0 x 2.5
XAOH NW 40 L 13	L	PN 160	42	15	M 52 x 2	M 22 x 1.5	41.5	50	60	38.0 x 2.5
XAOH NW 40 L 16	L	PN 160	42	18	M 52 x 2	M 26 X 1.5	42	50	60	38.0 x 2.5
XAOH NW 40 L 20	L	PN 160	42	22	M 52 x 2	M 30 x 2	44	50	60	38.0 x 2.5
XAOH NW 40 L 25	L	PN 160	42	28	M 52 x 2	M 36 x 2	44	50	60	38.0 x 2.5
XAOH NW 40 L 32	L	PN 160	42	35	M 52 x 2	M 45 x 2	43	50	60	38.0 x 2.5
XAOH NW 40 L	L	PN 160	42	42	M 52 x 2	M 52 x 2	42	55	60	38.0 x 2.5
XAOH NW 04 L 03 S	L / S	PN 315	6	6	M 12 x 1.5	M 14 x 1.5	29.5	17	14	4.0 x 1.5
XAOH NW 04 L 04 S	L / S	PN 315	6	8	M 12 x 1.5	M 16 x 1.5	29.5	17	14	4.0 x 1.5
XAOH NW 04 L 06 S	L / S	PN 315	6	10	M 12 x 1.5	M 18 x 1.5	29	19	14	4.0 x 1.5
XAOH NW 04 L 08 S	L / S	PN 315	6	12	M 12 x 1.5	M 20 x 1.5	31	22	14	4.0 x 1.5
XAOH NW 06 L 04 S	L / S	PN 315	8	8	M 14 x 1.5	M 16 x 1.5	30	17	17	6.0 x 1.5
XAOH NW 06 L 06 S	L / S	PN 315	8	10	M 14 x 1.5	M 18 x 1.5	29.5	19	17	6.0 x 1.5
XAOH NW 06 L 08 S	L / S	PN 315	8	12	M 14 x 1.5	M 20 x 1.5	31.5	22	17	6.0 x 1.5
XAOH NW 08 L 06 S	L / S	PN 315	10	10	M 16 x 1.5	M 18 x 1.5	32.5	19	19	7.5 x 1.5
XAOH NW 08 L 08 S	L / S	PN 315	10	12	M 16 x 1.5	M 20 x 1.5	32.5	22	19	7.5 x 1.5
XAOH NW 08 L 10 S	L / S	PN 315	10	14	M 16 x 1.5	M 22 x 1.5	34	24	19	7.5 x 1.5
XAOH NW 08 L 13 S	L / S	PN 315	10	16	M 16 x 1.5	M 24 x 1.5	33.5	27	19	7.5 x 1.5
XAOH NW 10 L 04 S	L / S	PN 315	12	8	M 18 x 1.5	M 16 x 1.5	31	19	22	9.0 x 1.5
XAOH NW 10 L 06 S	L / S	PN 315	12	10	M 18 x 1.5	M 18 x 1.5	30.5	19	22	9.0 x 1.5
XAOH NW 10 L 08 S	L / S	PN 315	12	12	M 18 x 1.5	M 20 x 1.5	33	22	22	9.0 x 1.5
XAOH NW 10 L 10 S	L / S	PN 315	12	14	M 18 x 1.5	M 22 x 1.5	35.5	24	22	9.0 x 1.5
XAOH NW 10 L 13 S	L / S	PN 315	12	16	M 18 x 1.5	M 24 x 1.5	33.5	27	22	9.0 x 1.5
XAOH NW 10 L 16 S	L / S	PN 315	12	20	M 18 x 1.5	M 30 x 2	29.5	32	22	9.0 x 1.5
XAOH NW 13 L 13 S	L / S	PN 315	15	16	M 22 x 1.5	M 24 x 1.5	35.5	27	27	12.0 x 2.0
XAOH NW 13 L 16 S	L / S	PN 315	15	20	M 22 x 1.5	M 30 x 2	32.5	32	27	12.0 x 2.0
XAOH NW 16 L 13 S	L / S	PN 315	18	16	M 26 x 1.5	M 24 x 1.5	31.5	27	32	16.0 x 2.0
XAOH NW 16 L 16 S	L / S	PN 315	18	20	M 26 x 1.5	M 30 x 2	37	32	32	16.0 x 2.0
XAOH NW 16 L 20 S	L / S	PN 315	18	25	M 26 x 1.5	M 36 x 2	33.5	41	32	16.0 x 2.0
XAOH NW 20 L 13 S	L / S	PN 160	22	16	M 30 x 2	M 24 x 1.5	34	27	36	20.0 x 2.0
XAOH NW 20 L 16 S	L / S	PN 160	22	20	M 30 x 2	M 30 x 2	41	32	36	20.0 x 2.0
XAOH NW 20 L 20 S	L / S	PN 160	22	25	M 30 x 2	M 36 x 2	43.5	41	36	20.0 x 2.0
XAOH NW 20 L 25 S	L / S	PN 160	22	30	M 30 x 2	M 42 x 2	43.5	46	36	20.0 x 2.0
XAOH NW 25 L 13 S	L / S	PN 160	28	16	M 36 x 2	M 24 x 2	36.5	32	41	26.0 x 2.0
XAOH NW 25 L 20 S	L / S	PN 160	28	25	M 36 x 2	M 36 x 2	44	41	41	26.0 x 2.0
XAOH NW 25 L 25 S	L / S	PN 160	28	30	M 36 x 2	M 42 x 2	43.5	46	41	26.0 x 2.0
XAOH NW 25 L 32 S	L / S	PN 160	28	38	M 26 x 2	M 52 x 2	47	55	41	26.0 x 2.0
XAOH NW 32 L 20 S	L / S	PN 160	35	25	M 45 x 2	M 36 x 2	40	41	50	32.0 x 2.5
XAOH NW 32 L 25 S	L / S	PN 160	35	30	M 45 x 2	M 42 x 2	40.5	46	50	32.0 x 2.5
XAOH NW 32 L 32 S	L / S	PN 160	35	38	M 45 X 2	M 52 x 2	50	55	50	32.0 x 2.5
XAOH NW 40 L 25 S	L / S	PN 160	42	30	M 52 x 2	M 42 x 2	42.5	50	60	38.0 x 2.5
XAOH NW 40 L 32 S	L / S	PN 160	42	38	M 52 x 2	M 52 x 2	45.5	55	60	38.0 x 2.5
XAOH NW 03 S	S	PN 630	6	6	M 14 x 1.5	M 14 x 1.5	36	14	17	4.0 x 1.5
XAOH NW 03 S 04	S	PN 630	6	8	M 14 x 1.5	M 16 x 1.5	30	17	17	4.0 x 1.5
XAOH NW 03 S 06	S	PN 630	6	10	M 14 x 1.5	M 18 x 1.5	29.5	19	17	4.0 x 1.5
XAOH NW 04 S 03	S	PN 630	8	6	M 16 x 1.5	M 14 x 1.5	28	14	19	6.0 x 1.5
XAOH NW 04 S	S	PN 630	8	8	M 16 x 1.5	M 16 x 1.5	37.5	17	17	6.0 x 1.5
XAOH NW 04 S 06	S	PN 630	8	10	M 16 x 1.5	M 18 x 1.5	30	19	19	6.0 x 1.5

24°锥可调式直通

XAOH

结构形式：直通

连接1：活动端公制螺母

密封形式：24°锥带O形圈密封

连接2：公制外螺纹

密封形式：24°内锥面密封

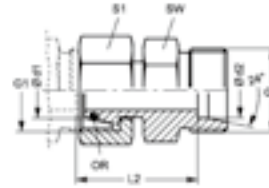

订货号	系列	工作压力 bar	Ød1 mm	Ød2 mm	G1	G2	L2 mm	SW mm	S1	OR
XAOH NW 04 S 08	S	PN 630	8	12	M 16 x 1.5	M 20 x 1.5	32	22	19	6.0 x 1.5
XAOH NW 04 S 13	S	PN 400	8	16	M 16 x 1.5	M 24 x 1.5	31.5	27	19	6.0 x 1.5
XAOH NW 06 S 03	S	PN 630	10	6	M 18 x 1.5	M 14 X 1.5	29.5	17	22	7.5 x 1.5
XAOH NW 06 S 04	S	PN 630	10	8	M 18 x 1.5	M 16 x 1.5	29.5	17	22	7.5 x 1.5
XAOH NW 06 S	S	PN 630	10	10	M 18 x 1.5	M 18 x 1.5	36.5	19	22	7.5 x 1.5
XAOH NW 06 S 08	S	PN 630	10	12	M 18 x 1.5	M 20 x 1.5	32.5	22	22	7.5 x 1.5
XAOH NW 06 S 10	S	PN 630	10	14	M 18 x 1.5	M 22 x 1.5	34	24	22	7.5 x 1.5
XAOH NW 06 S 13	S	PN 400	10	16	M 18 x 1.5	M 24 x 1.5	33.5	27	22	7.5 x 1.5
XAOH NW 08 S 03	S	PN 630	12	6	M 20 x 1.5	M 14 x 1.5	30	17	24	9.0 x 1.5
XAOH NW 08 S 04	S	PN 630	12	8	M 20 x 1.5	M 16 x 1.5	30	17	24	9.0 x 1.5
XAOH NW 08 S 06	S	PN 630	12	10	M 20 x 1.5	M 18 x 1.5	30.5	19	24	9.0 x 1.5
XAOH NW 08 S	S	PN 630	12	12	M 20 x 1.5	M 20 x 1.5	32.5	22	24	9.0 x 1.5
XAOH NW 08 S 10	S	PN 630	12	14	M 20 x 1.5	M 22 x 1.5	34	24	24	9.0 x 1.5
XAOH NW 08 S 13	S	PN 400	12	16	M 20 x 1.5	M 24 x 1.5	33.5	27	24	9.0 x 1.5
XAOH NW 08 S 16	S	PN 400	12	20	M 20 x 1.5	M 30 x 2	37	32	24	9.0 x 1.5
XAOH NW 10 S 03	S	PN 630	14	6	M 22 x 1.5	M 14 x 1.5	33	19	27	10.0 x 2.0
XAOH NW 10 S 04	S	PN 630	14	8	M 22 x 1.5	M 16 x 1.5	33	19	27	10.0 x 2.0
XAOH NW 10 S 06	S	PN 630	14	10	M 22 x 1.5	M 18 x 1.5	32.5	19	27	10.0 x 2.0
XAOH NW 10 S 08	S	PN 630	14	12	M 22 x 1.5	M 20 x 1.5	32.5	22	27	10.0 x 2.0
XAOH NW 10 S	S	PN 630	14	14	M 22 x 1.5	M 22 x 1.5	40	24	27	10.0 x 2.0
XAOH NW 10 S 13	S	PN 400	14	16	M 22 x 1.5	M 24 x 1.5	36	27	27	10.0 x 2.0
XAOH NW 10 S 16	S	PN 400	14	20	M 22 x 1.5	M 30 x 2	38	32	27	10.0 x 2.0
XAOH NW 13 S 03	S	PN 400	16	6	M 24 x 1.5	M 14 x 1.5	34	22	30	12.0 x 2.0
XAOH NW 13 S 04	S	PN 400	16	8	M 24 x 1.5	M 16 X 1.5	34	22	30	12.0 x 2.0
XAOH NW 13 S 06	S	PN 400	16	10	M 24 x 1.5	M 18 x 1.5	33.5	22	30	12.0 x 2.0
XAOH NW 13 S 08	S	PN 400	16	12	M 24 x 1.5	M 20 x 1.5	33.5	22	30	12.0 x 2.0
XAOH NW 13 S 10	S	PN 400	16	14	M 24 x 1.5	M 22 X 1.5	35.5	24	30	12.0 x 2.0
XAOH NW 13 S	S	PN 400	16	16	M 24 x 1.5	M 24 x 1.5	40	27	30	12.0 x 2.0
XAOH NW 13 S 16	S	PN 400	16	20	M 24 x 1.5	M 30 X 2	39	32	30	12.0 x 2.0
XAOH NW 13 S 20	S	PN 400	16	25	M 24 x 1.5	M 30 x 2	41.5	41	30	12.0 x 2.0
XAOH NW 16 S 03	S	PN 400	20	6	M 30 x 2	M 14 x 1.5	39	27	36	16.3 x 2.4
XAOH NW 16 S 04	S	PN 400	20	8	M 30 x 2	M 16 x 1.5	39	27	36	16.3 x 2.4
XAOH NW 16 S 06	S	PN 400	20	10	M 30 x 2	M 18 x 1.5	38.5	27	36	16.3 x 2.4
XAOH NW 16 S 08	S	PN 400	20	12	M 30 x 2	M 20 X 1.5	38.5	27	36	16.3 x 2.4
XAOH NW 16 S 10	S	PN 400	20	14	M 30 x 2	M 22 x 1.5	40	27	36	16.3 x 2.4
XAOH NW 16 S 13	S	PN 400	20	16	M 30 x 2	M 24 x 1.5	39.5	27	36	16.3 x 2.4
XAOH NW 16 S	S	PN 400	20	20	M 30 x 2	M 30 x 2	46	32	36	16.3 x 2.4
XAOH NW 16 S 20	S	PN 400	20	25	M 30 x 2	M 36 x 2	44.5	36	36	16.3 x 2.4
XAOH NW 16 S 25	S	PN 400	20	30	M 30 x 2	M 42 x 2	45	46	36	16.3 x 2.4
XAOH NW 16 S 32	S	PN 315	20	38	M 30 x 2	M 52 x 2	41.5	50	36	16.3 x 2.4
XAOH NW 20 S 03	S	PN 400	25	6	M 36 x 2	M 14 x 1.5	41.5	32	46	20.3 x 2.4
XAOH NW 20 S 04	S	PN 400	25	8	M 36 x 2	M 16 x 1.5	41.5	32	46	20.3 x 2.4
XAOH NW 20 S 06	S	PN 400	25	10	M 36 x 2	M 18 X 1.5	41	32	46	20.3 x 2.4
XAOH NW 20 S 08	S	PN 400	25	12	M 36 x 2	M 20 x 1.5	41	32	46	20.3 x 2.4
XAOH NW 20 S 10	S	PN 400	25	14	M 36 x 2	M 22 x 1.5	42.5	32	46	20.3 x 2.4
XAOH NW 20 S 13	S	PN 400	25	16	M 36 x 2	M 24 x 1.5	42	32	46	20.3 x 2.4
XAOH NW 20 S 16	S	PN 400	25	20	M 36 x 2	M 30 x 2	42	32	46	20.3 x 2.4
XAOH NW 20 S	S	PN 400	25	25	M 36 x 2	M 36 x 2	50	41	46	20.3 x 2.4
XAOH NW 20 S 25	S	PN 400	25	30	M 36 x 2	M 42 x 2	48	46	46	20.3 x 2.4
XAOH NW 20 S 32	S	PN 315	25	38	M 36 x 2	M 52 x 2	50.5	55	46	20.3 x 2.4
XAOH NW 25 S 03	S	PN 400	30	6	M 42 x 2	M 14 x 1.5	44	41	50	25.3 x 2.4
XAOH NW 25 S 04	S	PN 400	30	8	M 42 x 2	M 16 x 1.5	46	41	50	25.3 x 2.4
XAOH NW 25 S 06	S	PN 400	30	10	M 42 x 2	M 18 x 2	45.5	41	50	25.3 x 2.4
XAOH NW 25 S 08	S	PN 400	30	12	M 42 x 2	M 20 x 2	45.5	41	50	25.3 x 2.4
XAOH NW 25 S 10	S	PN 400	30	14	M 42 x 2	M 22 x 1.5	45	41	50	25.3 x 2.4
XAOH NW 25 S 13	S	PN 400	30	16	M 42 x 2	M 24 x 1.5	46.5	41	50	25.3 x 2.4
XAOH NW 25 S 16	S	PN 400	30	20	M 42 x 2	M 30 x 2	46.5	41	50	25.3 x 2.4
XAOH NW 25 S 20	S	PN 400	30	25	M 42 x 2	M 36 x 2	47	41	50	25.3 x 2.4
XAOH NW 25 S	S	PN 400	30	30	M 42 x 2	M 42 x 2	53.5	46	50	25.3 x 2.4

24°锥可调式直通

XAOH

结构形式：直通

连接1：活动端公制螺母

密封形式：24°锥带O形圈密封

连接2：公制外螺纹

密封形式：24°内锥面密封

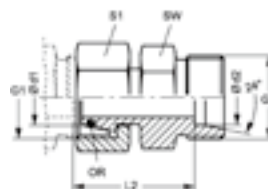

订货号	系列	工作压力 bar	Ød1 mm	Ød2 mm	G1	G2	L2 mm	SW mm	S1	OR
XAOH NW 25 S 32	S	PN 315	30	38	M 42 x 2	M 52 x 2	56.5	55	50	25.3 x 2.4
XAOH NW 32 S 03	S	PN 315	38	6	M 52 x 2	M 14 x 1.5	47.5	50	60	33.3 x 2.4
XAOH NW 32 S 04	S	PN 315	38	8	M 52 x 2	M 16 x 1.5	47.5	50	60	33.3 x 2.4
XAOH NW 32 S 06	S	PN 315	38	10	M 52 x 2	M 18 x 1.5	47	50	60	33.3 x 2.4
XAOH NW 32 S 08	S	PN 315	38	12	M 52 x 2	M 20 x 1.5	50	50	60	33.3 x 2.4
XAOH NW 32 S 10	S	PN 315	38	14	M 52 x 2	M 22 x 1.5	48.5	50	60	33.3 x 2.4
XAOH NW 32 S 13	S	PN 315	38	16	M 52 x 2	M 24 x 1.5	51	50	60	33.3 x 2.4
XAOH NW 32 S 16	S	PN 315	38	20	M 52 x 2	M 30 x 2	51	50	60	33.3 x 2.4
XAOH NW 32 S 20	S	PN 315	38	25	M 52 x 2	M 36 x 2	51.5	50	60	33.3 x 2.4
XAOH NW 32 S 25	S	PN 315	38	30	M 52 x 2	M 42 x 2	52	50	60	33.3 x 2.4
XAOH NW 32 S	S	PN 315	38	38	M 52 x 2	M 52 x 2	57	55	60	33.3 x 2.4
XAOH NW 03 S 04 L	S / L	PN 315	6	6	M 14 x 1.5	M 12 x 1.5	24.5	12	17	4.0 x 1.5
XAOH NW 03 S 06 L	S / L	PN 315	6	8	M 14 x 1.5	M 14 x 1.5	23.5	14	17	4.0 x 1.5
XAOH NW 04 S 04 L	S / L	PN 315	8	6	M 16 x 1.5	M 12 x 1.5	24	12	19	6.0 x 1.5
XAOH NW 04 S 06 L	S / L	PN 315	8	8	M 16 x 1.5	M 14 x 1.5	24.5	14	19	6.0 x 1.5
XAOH NW 04 S 08 L	S / L	PN 315	8	10	M 16 x 1.5	M 16 x 1.5	36	19	19	6.0 x 1.5
XAOH NW 04 S 10 L	S / L	PN 315	8	12	M 16 x 1.5	M 18 x 1.5	27.5	19	19	6.0 x 1.5
XAOH NW 06 S 06 L	S / L	PN 315	10	8	M 18 x 1.5	M 14 x 1.5	26	17	22	7.5 x 1.5
XAOH NW 06 S 08 L	S / L	PN 315	10	10	M 18 x 1.5	M 16 x 1.5	27	17	22	7.5 x 1.5
XAOH NW 06 S 10 L	S / L	PN 315	10	12	M 18 x 1.5	M 18 x 1.5	27.5	19	22	7.5 x 1.5
XAOH NW 06 S 13 L	S / L	PN 315	10	15	M 18 x 1.5	M 22 x 1.5	29	24	22	7.5 x 1.5
XAOH NW 08 S 06 L	S / L	PN 315	12	8	M 20 x 1.5	M 14 x 1.5	27	17	24	9.0 x 1.5
XAOH NW 08 S 08 L	S / L	PN 315	12	10	M 20 x 1.5	M 16 x 1.5	29.5	17	24	9.0 x 1.5
XAOH NW 08 S 10 L	S / L	PN 315	12	12	M 20 x 1.5	M 18 x 1.5	29.5	19	24	9.0 x 1.5
XAOH NW 08 S 13 L	S / L	PN 315	12	15	M 20 x 1.5	M 22 x 1.5	30.5	24	24	9.0 x 1.5
XAOH NW 08 S 16 L	S / L	PN 315	12	18	M 20 x 1.5	M 26 x 1.5	34	27	24	9.0 x 1.5
XAOH NW 10 S 10 L	S / L	PN 315	14	12	M 22 x 1.5	M 18 x 1.5	30.5	19	27	10.0 x 2.0
XAOH NW 10 S 13 L	S / L	PN 315	14	15	M 22 x 1.5	M 22 x 1.5	42.5	24	27	10.0 x 2.0
XAOH NW 10 S 16 L	S / L	PN 315	14	18	M 22 x 1.5	M 26 x 1.5	35	27	27	10.0 x 2.0
XAOH NW 13 S 13 L	S / L	PN 315	16	15	M 24 x 1.5	M 22 x 1.5	32.5	24	30	12.0 x 2.0
XAOH NW 13 S 16 L	S / L	PN 315	16	18	M 24 x 1.5	M 26 x 1.5	33	27	30	12.0 x 2.0
XAOH NW 13 S 20 L	S / L	PN 160	16	22	M 24 x 1.5	M 30 x 2	35	32	30	12.0 x 2.0
XAOH NW 16 S 13 L	S / L	PN 315	20	15	M 30 x 2	M 22 x 1.5	38	27	36	16.3 x 2.4
XAOH NW 16 S 16 L	S / L	PN 315	20	18	M 30 x 2	M 26 x 1.5	35.5	27	36	16.3 x 2.4
XAOH NW 16 S 20 L	S / L	PN 160	20	22	M 30 x 2	M 30 x 2	38	32	36	16.3 x 2.4
XAOH NW 16 S 25 L	S / L	PN 160	20	28	M 30 x 2	M 36 x 2	39	41	36	16.3 x 2.4
XAOH NW 20 S 13 L	S / L	PN 315	25	15	M 36 x 2	M 22 x 1.5	40.5	32	46	20.3 x 2.4
XAOH NW 20 S 16 L	S / L	PN 315	25	18	M 36 x 2	M 26 x 1.5	38	32	46	20.3 x 2.4
XAOH NW 20 S 20 L	S / L	PN 160	25	22	M 36 x 2	M 30 x 2	42	32	46	20.3 x 2.4
XAOH NW 20 S 25 L	S / L	PN 160	25	28	M 36 x 2	M 36 x 2	42	41	46	20.3 x 2.4
XAOH NW 20 S 32 L	S / L	PN 160	25	35	M 36 x 2	M 45 x 2	42	46	46	20.3 x 2.4
XAOH NW 25 S 20 L	S / L	PN 160	30	22	M 42 x 2	M 30 x 2	45	41	50	25.3 x 2.4
XAOH NW 25 S 25 L	S / L	PN 160	30	28	M 42 x 2	M 36 x 2	45.5	41	50	25.3 x 2.4
XAOH NW 25 S 32 L	S / L	PN 160	30	35	M 42 x 2	M 45 x 2	45.5	46	50	25.3 x 2.4
XAOH NW 25 S 40 L	S / L	PN 160	30	42	M 42 x 2	M 52 x 2	47	55	50	25.3 x 2.4
XAOH NW 32 S 25 L	S / L	PN 160	38	28	M 52 x 2	M 36 x 2	50	50	60	33.3 x 2.4
XAOH NW 32 S 32 L	S / L	PN 160	38	35	M 52 x 2	M 45 x 2	48	50	60	33.3 x 2.4
XAOH NW 32 S 40 L	S / L	PN 160	38	42	M 52 x 2	M 52 x 2	50.5	55	60	33.3 x 2.4

系列：LL=特轻系列 L=轻系列 S=重系列

24°锥可调式弯通(45°角)

结构形式: 45°角

连接1: 活动端公制螺母

密封形式: 24°锥带O形圈密封

连接2: 公制外螺纹

密封形式: 24°内锥面密封

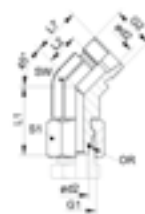

XVEWO 45



订货号	系列	工作压力 bar	Ød2 mm	G1 - G2	管外径 mm	L1 mm	L2 mm	L7 mm	SW mm	S1	OR
XVEWO 45 NW 04 HL	L	PN 315	6	M 12 x 1.5	6	26.0	9.0	16.0	14	14	4.0 x 1.5
XVEWO 45 NW 06 HL	L	PN 315	8	M 14 x 1.5	8	27.5	12.0	19.0	14	17	6.0 x 1.5
XVEWO 45 NW 08 HL	L	PN 315	10	M 16 x 1.5	10	29.0	12.0	19.0	19	19	7.5 x 1.5
XVEWO 45 NW 10 HL	L	PN 315	12	M 18 x 1.5	12	29.5	14.0	21.0	19	22	9.0 x 1.5
XVEWO 45 NW 13 HL	L	PN 315	15	M 22 x 1.5	15	32.5	17.0	24.0	22	27	12.0 x 2.0
XVEWO 45 NW 16 HL	L	PN 315	18	M 26 x 1.5	18	35.5	16.5	24.0	27	32	15.0 x 2.0
XVEWO 45 NW 20 HL	L	PN 160	22	M 30 x 2	22	38.5	18.5	26.0	30	36	20.0 x 2.0
XVEWO 45 NW 25 HL	L	PN 160	28	M 36 x 2	28	41.5	23.0	30.5	36	41	26.0 x 2.0
XVEWO 45 NW 32 HL	L	PN 160	35	M 45 x 2	35	51.0	26.5	37.0	50	50	32.0 x 2.5
XVEWO 45 NW 40 HL	L	PN 160	42	M 52 x 2	42	56.0	26.0	37.0	50	60	38.0 x 2.5
XVEWO 45 NW 03 HS	S	PN 630	6	M 14 x 1.5	6	27.0	9.0	16.0	14	17	4.0 x 1.5
XVEWO 45 NW 04 HS	S	PN 630	8	M 16 x 1.5	8	27.5	12.0	19.0	19	19	6.0 x 1.5
XVEWO 45 NW 06 HS	S	PN 630	10	M 18 x 1.5	10	30.0	13.5	21.0	19	22	7.5 x 1.5
XVEWO 45 NW 08 HS	S	PN 630	12	M 20 x 1.5	12	31.0	16.5	24.0	19	24	9.0 x 1.5
XVEWO 45 NW 13 HS	S	PN 400	16	M 24 x 1.5	16	36.5	15.5	24.0	19	30	12.0 x 2.0
XVEWO 45 NW 16 HS	S	PN 400	20	M 30 x 2	20	44.5	16.0	26.5	27	36	16.3 x 2.4
XVEWO 45 NW 20 HS	S	PN 400	25	M 36 x 2	25	50.0	18.5	30.5	36	46	20.3 x 2.4
XVEWO 45 NW 25 HS	S	PN 400	30	M 42 x 2	30	55.0	23.5	37.0	50	50	25.3 x 2.4
XVEWO 45 NW 32 HS	S	PN 315	38	M 52 x 2	38	63.0	21.0	37.0	50	60	33.3 x 2.4

系列: LL=特轻系列 L=轻系列 S=重系列; G1-G2=接口螺纹

24°锥可调式直角

结构形式: 90°角

连接1: 活动端公制螺母

密封形式: 24°锥带O形圈密封

连接2: 公制外螺纹

密封形式: 24°内锥面密封

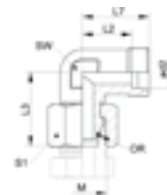

XVEWO



订货号	系列	工作压力 bar	Ød2 mm	管外径 mm	M	L2 mm	L3 mm	L7 mm	SW mm	S1	OR
XVEWO NW 04 HL	L	PN 315	6	6	M 12 x 1.5	12.0	25.0	19	12	14	4.0 x 1.5
XVEWO NW 06 HL	L	PN 315	8	8	M 14 x 1.5	14.0	26.5	21	12	17	6.0 x 1.5
XVEWO NW 08 HL	L	PN 315	10	10	M 16 x 1.5	15.0	29.0	22	14	19	7.5 x 1.5
XVEWO NW 10 HL	L	PN 315	12	12	M 18 x 1.5	17.0	29.5	24	17	22	9.0 x 1.5
XVEWO NW 13 HL	L	PN 315	15	15	M 22 x 1.5	21.0	33.0	28	19	27	12.0 x 2.0
XVEWO NW 16 HL	L	PN 315	18	18	M 26 x 1.5	23.5	35.5	31	24	32	15.0 x 2.0
XVEWO NW 20 HL	L	PN 160	22	22	M 30 x 2	27.5	39.5	35	27	36	20.0 x 2.0
XVEWO NW 25 HL	L	PN 160	28	28	M 36 x 2	30.5	43.0	38	36	41	26.0 x 2.0
XVEWO NW 32 HL	L	PN 160	35	35	M 45 x 2	34.5	51.5	45	41	50	32.0 x 2.5
XVEWO NW 40 HL	L	PN 160	42	42	M 52 x 2	40.0	56.0	51	50	60	38.0 x 2.5
XVEWO NW 03 HS	S	PN 630	6	6	M 14 x 1.5	16.0	27.0	23	12	17	4.0 x 1.5
XVEWO NW 04 HS	S	PN 630	8	8	M 16 x 1.5	17.0	27.5	24	14	19	6.0 x 1.5
XVEWO NW 06 HS	S	PN 630	10	10	M 18 x 1.5	17.5	30.5	25	17	22	7.5 x 1.5
XVEWO NW 08 HS	S	PN 630	12	12	M 20 x 1.5	21.5	31.5	29	17	24	9.0 x 1.5
XVEWO NW 10 HS	S	PN 630	14	14	M 22 x 1.5	22.0	36.5	30	19	27	10.0 x 2.0
XVEWO NW 13 HS	S	PN 400	16	16	M 24 x 1.5	24.5	37.5	33	24	30	12.0 x 2.0
XVEWO NW 16 HS	S	PN 400	20	20	M 30 x 2	26.5	45.0	37	27	36	-
XVEWO NW 20 HS	S	PN 400	25	25	M 36 x 2	30.0	50.5	42	36	46	-
XVEWO NW 25 HS	S	PN 400	30	30	M 42 x 2	35.5	55.0	49	41	50	25.3 x 2.4
XVEWO NW 32 HS	S	PN 315	38	38	M 52 x 2	57	41	57	50	60	33.3 x 2.4

系列: LL=特轻系列 L=轻系列 S=重系列

24°锥可调式直通 (L型)

结构形式: L形

连接1: 活动端公制螺母

密封形式: 24°带O形圈密封

连接2: 公制外螺纹

密封形式: 24°内锥面密封

连接3: 公制外螺纹

密封形式: 24°内锥面密封

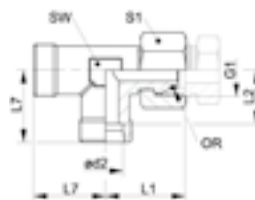

XVELO



订货号	系列	工作压力 bar	Ød2 mm	G1	管外径Ø mm	L1 mm	L2 mm	L7 mm	SW mm	S1	OR
XVELO NW 04 HL	L	PN 315	6	M 12 x 1.5	6	26.0	12.0	19	12	14	4.0 x 1.5
XVELO NW 06 HL	L	PN 315	8	M 14 x 1.5	8	26.5	14.0	21	12	17	6.0 x 1.5
XVELO NW 08 HL	L	PN 315	10	M 16 x 1.5	10	29.0	15.0	22	14	19	7.5 x 1.5
XVELO NW 10 HL	L	PN 315	12	M 18 x 1.5	12	29.5	17.0	24	17	22	9.0 x 1.5
XVELO NW 13 HL	L	PN 315	15	M 22 x 1.5	15	33.0	21.0	28	19	27	12.0 x 2.0
XVELO NW 16 HL	L	PN 315	18	M 26 x 1.5	18	35.5	23.5	31	24	32	15.0 x 2.0
XVELO NW 20 HL	L	PN 160	22	M 30 x 2	22	38.5	27.5	35	27	36	20.0 x 2.0
XVELO NW 25 HL	L	PN 160	28	M 36 x 2	28	43.0	30.5	38	36	41	26.0 x 2.0
XVELO NW 32 HL	L	PN 160	35	M 45 x 2	35	51.5	34.5	45	41	50	32.0 x 2.5
XVELO NW 40 HL	L	PN 160	42	M 52 x 2	42	56.0	40.0	51	50	60	38.0 x 2.5
XVELO NW 03 HS	S	PN 630	6	M 14 x 1.5	6	27.0	16.0	23	12	17	4.0 x 1.5
XVELO NW 04 HS	S	PN 630	8	M 16 x 1.5	8	27.5	17.0	24	14	19	6.0 x 1.5
XVELO NW 06 HS	S	PN 630	10	M 18 x 1.5	10	30.5	17.5	25	17	22	7.5 x 1.5
XVELO NW 08 HS	S	PN 630	12	M 20 x 1.5	12	31.0	21.5	29	17	24	9.0 x 1.5
XVELO NW 10 HS	S	PN 630	14	M 22 x 1.5	14	35.0	22.0	30	19	27	10.0 x 2.0
XVELO NW 13 HS	S	PN 400	16	M 24 x 1.5	16	37.5	24.5	33	24	30	12.0 x 2.0
XVELO NW 16 HS	S	PN 400	20	M 30 x 2	20	44.5	26.5	37	27	36	16.3 x 2.4
XVELO NW 20 HS	S	PN 400	25	M 36 x 2	25	50.5	30.0	42	36	46	25.3 x 2.4
XVELO NW 25 HS	S	PN 400	30	M 42 x 2	30	55.0	35.5	49	41	50	33.3 x 2.4
XVELO NW 32 HS	S	PN 315	38	M 52 x 2	38	62.4	41.0	57	50	60	33.3 x 2.4

系列: LL=特轻系列 L=轻系列 S=重系列; G1=接口螺纹

结构形式: L形

连接1: 活动端公制螺母

密封形式: 卡套预安装式连接

连接2: 公制外螺纹

密封形式: 24°内锥面密封

连接3: 公制外螺纹

密封形式: 24°内锥面密封

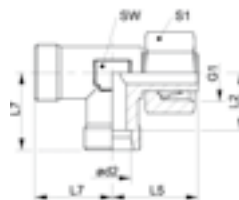

XVEL



订货号	系列	工作压力 bar	Ød2 mm	G1	管外径Ø mm	L2 mm	L5 mm	L7 mm	SW mm	S1
XVEL NW 04 HL	L	PN 315	6	M 12 x 1.5	6	12.0	26.0	19	12	14
XVEL NW 06 HL	L	PN 315	8	M 14 x 1.5	8	14.0	27.5	21	12	17
XVEL NW 08 HL	L	PN 315	10	M 16 x 1.5	10	15.0	29.0	22	14	19
XVEL NW 10 HL	L	PN 315	12	M 18 x 1.5	12	17.0	29.5	24	17	22
XVEL NW 13 HL	L	PN 315	15	M 22 x 1.5	15	21.0	32.5	28	19	27
XVEL NW 16 HL	L	PN 315	18	M 26 x 1.5	18	23.5	35.5	31	24	32
XVEL NW 20 HL	L	PN 160	22	M 30 x 2	22	27.5	38.5	35	27	36
XVEL NW 25 HL	L	PN 160	28	M 36 x 2	28	30.5	41.5	38	36	41
XVEL NW 32 HL	L	PN 160	35	M 45 x 2	35	34.5	51.0	45	41	50
XVEL NW 40 HL	L	PN 160	42	M 52 x 2	42	40.0	56.0	51	50	60
XVEL NW 03 HS	S	PN 630	6	M 14 x 1.5	6	16.0	27.0	23	12	17
XVEL NW 04 HS	S	PN 630	8	M 16 x 1.5	8	17.0	27.5	24	14	19
XVEL NW 06 HS	S	PN 630	10	M 18 x 1.5	10	17.5	30.0	25	17	22
XVEL NW 08 HS	S	PN 630	12	M 20 x 1.5	12	21.5	31.0	29	17	24
XVEL NW 10 HS	S	PN 630	14	M 22 x 1.5	14	22.0	35.0	30	19	27
XVEL NW 13 HS	S	PN 400	16	M 24 x 1.5	16	24.5	36.5	33	24	30
XVEL NW 16 HS	S	PN 400	20	M 30 x 2	20	26.5	44.5	37	27	36
XVEL NW 20 HS	S	PN 400	25	M 36 x 2	25	30.0	50.0	42	36	46
XVEL NW 25 HS	S	PN 400	30	M 42 x 2	30	35.5	55.0	49	41	50
XVEL NW 32 HS	S	PN 315	38	M 52 x 2	38	41.0	63.0	57	50	60

系列: LL=特轻系列 L=轻系列 S=重系列; G1=接口螺纹

24°锥可调式直通 (T型)

XVETO

结构形式: T形

连接1: 活动端公制螺母

密封形式: 24°锥带O形圈密封

连接2: 公制外螺纹

密封形式: 24°内锥面密封

连接3: 公制外螺纹

密封形式: 24°内锥面密封

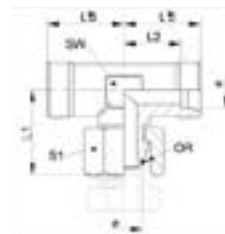

订货号	系列	工作压力 bar	Ød2 mm	管外径 mm	L1 mm	L2 mm	L7 mm	SW mm	S1	OR
XVETO NW 04 HL	L	PN 315	6	6	26.0	12.0	19	12	14	4.0 x 1.5
XVETO NW 06 HL	L	PN 315	8	8	26.5	14.0	21	12	17	6.0 x 1.5
XVETO NW 08 HL	L	PN 315	10	10	29.0	15.0	22	14	19	7.5 x 1.5
XVETO NW 10 HL	L	PN 315	12	12	29.5	17.0	24	17	22	9.0 x 1.5
XVETO NW 13 HL	L	PN 315	15	15	33.0	21.0	28	19	27	12.0 x 2.0
XVETO NW 16 HL	L	PN 315	18	18	35.5	23.5	31	24	32	15.0 x 2.0
XVETO NW 20 HL	L	PN 160	22	22	39.5	27.5	35	27	36	20.0 x 2.0
XVETO NW 25 HL	L	PN 160	28	28	43.0	30.5	38	36	41	26.0 x 2.0
XVETO NW 32 HL	L	PN 160	35	35	51.0	34.5	45	41	50	32.0 x 2.5
XVETO NW 40 HL	L	PN 160	42	42	56.0	40.0	51	50	60	38.0 x 2.5
XVETO NW 03 HS	S	PN 630	6	6	27.0	16.0	23	12	17	4.0 x 1.5
XVETO NW 04 HS	S	PN 630	8	8	27.5	17.0	24	14	19	6.0 x 1.5
XVETO NW 06 HS	S	PN 630	10	10	30.0	17.5	25	17	22	7.5 x 1.5
XVETO NW 08 HS	S	PN 630	12	12	31.5	21.5	29	17	24	9.0 x 1.5
XVETO NW 10 HS	S	PN 630	14	14	35.0	22.0	30	19	27	10.0 x 2.0
XVETO NW 13 HS	S	PN 400	16	16	37.5	24.5	33	24	30	12.0 x 2.0
XVETO NW 16 HS	S	PN 400	20	20	45.0	26.5	37	27	36	16.3 x 2.4
XVETO NW 20 HS	S	PN 400	25	25	50.5	30.0	42	36	46	25.3 x 2.4
XVETO NW 25 HS	S	PN 400	30	30	55.0	35.5	49	41	50	33.3 x 2.4
XVETO NW 32 HS	S	PN 315	38	38	63.0	41.0	57	50	60	33.3 x 2.4

系列: LL=特轻系列 L=轻系列 S=重系列

24°锥可调式直通 (T型)

XVET

结构形式: T形

连接1: 活动端公制螺母

密封形式: 卡套预安装式连接

连接2: 公制外螺纹

密封形式: 24°内锥面密封

连接3: 公制外螺纹

密封形式: 24°内锥面密封



订货号	系列	工作压力 bar	Ød2 mm	G1	管外径 mm	L2 mm	L5 mm	L7 mm	SW mm	S1
XVET NW 04 HL	L	PN 315	6	M 12 x 1.5	6	12.0	26.0	19	12	14
XVET NW 06 HL	L	PN 315	8	M 14 x 1.5	8	14.0	27.5	21	12	17
XVET NW 08 HL	L	PN 315	10	M 16 x 1.5	10	15.0	29.0	22	14	19
XVET NW 10 HL	L	PN 315	12	M 18 x 1.5	12	17.0	29.5	24	17	22
XVET NW 13 HL	L	PN 315	15	M 22 x 1.5	15	21.0	32.5	28	19	27
XVET NW 16 HL	L	PN 315	18	M 26 x 1.5	18	23.5	35.5	31	24	32
XVET NW 20 HL	L	PN 160	22	M 30 x 2	22	27.5	38.5	35	27	36
XVET NW 25 HL	L	PN 160	28	M 36 x 2	28	30.5	41.5	38	36	41
XVET NW 32 HL	L	PN 160	35	M 45 x 2	35	34.5	51.0	45	41	50
XVET NW 40 HL	L	PN 160	42	M 52 x 2	42	40.0	56.0	51	50	60
XVET NW 03 HS	S	PN 630	6	M 14 x 1.5	6	16.0	27.0	23	12	17
XVET NW 04 HS	S	PN 630	8	M 16 x 1.5	8	17.0	27.5	24	14	19
XVET NW 06 HS	S	PN 630	10	M 18 x 1.5	10	17.5	30.0	25	17	22
XVET NW 08 HS	S	PN 630	12	M 20 x 1.5	12	21.5	31.0	29	17	24
XVET NW 10 HS	S	PN 630	14	M 22 x 1.5	14	22.0	35.0	30	19	27
XVET NW 13 HS	S	PN 400	16	M 24 x 1.5	16	24.5	36.5	33	24	30
XVET NW 16 HS	S	PN 400	20	M 30 x 2	20	26.5	44.5	37	27	36
XVET NW 20 HS	S	PN 400	25	M 36 x 2	25	30.0	50.0	42	36	46
XVET NW 25 HS	S	PN 400	30	M 42 x 2	30	35.5	55.0	49	41	50
XVET NW 32 HS	S	PN 315	38	M 52 x 2	38	41.0	63.0	57	50	60

系列: LL=特轻系列 L=轻系列 S=重系列; G1=接口螺纹

端对接组合接头

DMO

结构形式: 双螺母
 连接1: 活动端公制螺母
 密封形式: 24°锥带O形圈密封
 连接2: 活动端公制螺母
 密封形式: 24°锥带O形圈密封

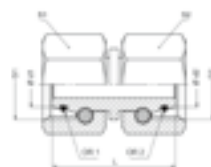

订货号	系列	工作压力 bar	Ød1 mm	Ød2 mm	G1	G2	L mm	S1	S2	OR1	OR2
DMO NW 04 L	L	PN 315	6	6	M 12 x 1.5	M 12 x 1.5	32.0	14	14	4.0 x 1.5	4.0 x 1.5
DMO NW 04 L 06	L	PN 315	6	8	M 12 x 1.5	M 14 x 1.5	32.0	14	17	4.0 x 1.5	6.0 x 1.5
DMO NW 04 L 08	L	PN 315	6	10	M 12 x 1.5	M 16 x 1.5	33.0	14	19	4.0 x 1.5	7.5 x 1.5
DMO NW 04 L 10	L	PN 315	6	12	M 12 x 1.5	M 18 x 1.5	33.0	14	22	4.0 x 1.5	9.0 x 1.5
DMO NW 06 L	L	PN 315	8	8	M 14 x 1.5	M 14 x 1.5	32.0	17	17	6.0 x 1.5	6.0 x 1.5
DMO NW 06 L 08	L	PN 315	8	10	M 14 x 1.5	M 16 x 1.5	33.0	17	19	6.0 x 1.5	7.5 x 1.5
DMO NW 06 L 10	L	PN 315	8	12	M 14 x 1.5	M 18 x 1.5	33.0	17	22	6.0 x 1.5	9.0 x 1.5
DMO NW 06 L 13	L	PN 315	8	15	M 14 x 1.5	M 22 x 1.5	34.5	17	27	6.0 x 1.5	12.0 x 2.0
DMO NW 06 L 16	L	PN 315	8	18	M 14 x 1.5	M 26 x 1.5	36.0	17	32	6.0 x 1.5	15.0 x 2.0
DMO NW 08 L	L	PN 315	10	10	M 16 x 1.5	M 16 x 1.5	34.0	19	19	7.5 x 1.5	7.5 x 1.5
DMO NW 08 L 10	L	PN 315	10	12	M 16 x 1.5	M 18 x 1.5	33.0	19	22	7.5 x 1.5	9.0 x 1.5
DMO NW 08 L 13	L	PN 315	10	15	M 16 x 1.5	M 22 x 1.5	38.0	19	27	7.5 x 1.5	12.0 x 2.0
DMO NW 08 L 16	L	PN 315	10	18	M 16 x 1.5	M 26 x 1.5	36.0	19	32	7.5 x 1.5	15.0 x 2.0
DMO NW 10 L	L	PN 315	12	12	M 18 x 1.5	M 18 x 1.5	34.5	22	22	9.0 x 1.5	9.0 x 1.5
DMO NW 10 L 13	L	PN 315	12	15	M 18 x 1.5	M 22 x 1.5	38.0	22	27	9.0 x 1.5	12.0 x 2.0
DMO NW 10 L 16	L	PN 315	12	18	M 18 x 1.5	M 26 x 1.5	36.0	22	32	9.0 x 1.5	15.0 x 2.0
DMO NW 10 L 20	L	PN 160	12	22	M 18 x 1.5	M 30 x 2	40.0	22	36	9.0 x 1.5	20.0 x 2.0
DMO NW 13 L	L	PN 315	15	15	M 22 x 1.5	M 22 x 1.5	37.0	27	27	12.0 x 2.0	12.0 x 2.0
DMO NW 13 L 16	L	PN 315	15	18	M 22 x 1.5	M 26 x 1.5	36.0	27	32	12.0 x 2.0	15.0 x 2.0
DMO NW 13 L 20	L	PN 160	15	22	M 22 x 1.5	M 30 x 2	42.0	27	36	12.0 x 2.0	20.0 x 2.0
DMO NW 13 L 25	L	PN 160	15	28	M 22 x 1.5	M 36 x 2	46.0	27	41	12.0 x 2.0	26.0 x 2.0
DMO NW 16 L	L	PN 315	18	18	M 26 x 1.5	M 26 x 1.5	38.5	32	32	15.0 x 2.0	15.0 x 2.0
DMO NW 16 L 20	L	PN 160	18	22	M 26 x 1.5	M 30 x 2	42.0	32	36	15.0 x 2.0	20.0 x 2.0
DMO NW 16 L 25	L	PN 160	18	28	M 26 x 1.5	M 36 x 2	46.0	32	41	15.0 x 2.0	26.0 x 2.0
DMO NW 16 L 32	L	PN 160	18	35	M 26 x 1.5	M 45 x 2	45.0	32	50	15.0 x 2.0	32.0 x 2.5
DMO NW 20 L	L	PN 160	22	22	M 30 x 2	M 30 x 2	42.5	36	36	20.0 x 2.0	20.0 x 2.0
DMO NW 20 L 25	L	PN 160	22	28	M 30 x 2	M 36 x 2	46.0	36	41	20.0 x 2.0	26.0 x 2.0
DMO NW 20 L 32	L	PN 160	22	35	M 30 x 2	M 45 x 2	48.0	36	50	20.0 x 2.0	32.0 x 2.5
DMO NW 20 L 40	L	PN 160	22	42	M 30 x 2	M 52 x 2	47.5	36	60	20.0 x 2.0	38.0 x 2.5
DMO NW 25 L	L	PN 160	28	28	M 36 x 2	M 36 x 2	44.5	41	41	26.0 x 2.0	26.0 x 2.0
DMO NW 25 L 32	L	PN 160	28	35	M 36 x 2	M 45 x 2	48.0	41	50	26.0 x 2.0	32.0 x 2.5
DMO NW 25 L 40	L	PN 160	28	42	M 36 x 2	M 52 x 2	52.0	41	60	26.0 x 2.0	38.0 x 2.5
DMO NW 32 L	L	PN 160	35	35	M 45 x 2	M 45 x 2	51.0	50	50	32.0 x 2.5	32.0 x 2.5
DMO NW 32 L 40	L	PN 160	35	42	M 45 x 2	M 52 x 2	51.5	50	60	32.0 x 2.5	38.0 x 2.5
DMO NW 40 L	L	PN 160	42	42	M 52 x 2	M 52 x 2	52.0	60	60	38.0 x 2.5	38.0 x 2.5
DMO NW 04 L 03 S	L / S	PN 315	6	6	M 12 x 1.5	M 14 x 1.5	33.5	14	17	4.0 x 1.5	4.0 x 1.5
DMO NW 04 L 04 S	L / S	PN 315	6	8	M 12 x 1.5	M 16 x 1.5	33.0	14	19	4.0 x 1.5	6.0 x 1.5
DMO NW 04 L 06 S	L / S	PN 315	6	10	M 12 x 1.5	M 18 x 1.5	35.5	14	22	4.0 x 1.5	7.5 x 1.5
DMO NW 04 L 08 S	L / S	PN 315	6	12	M 12 x 1.5	M 20 x 1.5	38.0	14	24	4.0 x 1.5	9.0 x 1.5
DMO NW 06 L 03 S	L / S	PN 315	8	6	M 14 x 1.5	M 14 x 1.5	32.0	17	17	6.0 x 1.5	4.0 x 1.5
DMO NW 06 L 04 S	L / S	PN 315	8	8	M 14 x 1.5	M 16 x 1.5	33.0	17	19	6.0 x 1.5	6.0 x 1.5
DMO NW 06 L 06 S	L / S	PN 315	8	10	M 14 x 1.5	M 18 x 1.5	33.0	17	22	6.0 x 1.5	7.5 x 1.5
DMO NW 06 L 08 S	L / S	PN 315	8	12	M 14 x 1.5	M 20 x 1.5	36.0	17	24	6.0 x 1.5	9.0 x 1.5
DMO NW 06 L 13 S	L / S	PN 315	8	16	M 14 x 1.5	M 24 x 1.5	39.0	17	30	6.0 x 1.5	12.0 x 2.0
DMO NW 08 L 03 S	L / S	PN 315	10	6	M 16 x 1.5	M 14 x 1.5	33.0	19	17	7.5 x 1.5	4.0 x 1.5
DMO NW 08 L 04 S	L / S	PN 315	10	8	M 16 x 1.5	M 16 x 1.5	33.0	19	19	7.5 x 1.5	6.0 x 1.5
DMO NW 08 L 06 S	L / S	PN 315	10	10	M 16 x 1.5	M 18 x 1.5	33.0	19	22	7.5 x 1.5	7.5 x 1.5
DMO NW 08 L 08 S	L / S	PN 315	10	12	M 16 x 1.5	M 20 x 1.5	36.0	19	24	7.5 x 1.5	9.0 x 1.5
DMO NW 08 L 10 S	L / S	PN 315	10	14	M 16 x 1.5	M 22 x 1.5	39.0	19	27	7.5 x 1.5	10.0 x 2.0
DMO NW 08 L 13 S	L / S	PN 315	10	16	M 16 x 1.5	M 24 x 1.5	39.0	19	30	7.5 x 1.5	12.0 x 2.0
DMO NW 10 L 06 S	L / S	PN 315	12	10	M 18 x 1.5	M 18 x 1.5	33.0	22	22	9.0 x 1.5	7.5 x 1.5
DMO NW 10 L 08 S	L / S	PN 315	12	12	M 18 x 1.5	M 20 x 1.5	36.0	22	24	9.0 x 1.5	9.0 x 1.5
DMO NW 10 L 10 S	L / S	PN 315	12	14	M 18 x 1.5	M 22 x 1.5	39.0	22	27	9.0 x 1.5	10.0 x 2.0
DMO NW 10 L 13 S	L / S	PN 315	12	16	M 18 x 1.5	M 24 x 1.5	39.0	22	30	9.0 x 1.5	12.0 x 2.0
DMO NW 10 L 16 S	L / S	PN 315	12	20	M 18 x 1.5	M 30 x 2	36.0	22	36	9.0 x 1.5	16.3 x 2.4
DMO NW 13 L 06 S	L / S	PN 315	15	10	M 22 x 1.5	M 18 x 1.5	38.0	27	22	12.0 x 2.0	7.5 x 1.5
DMO NW 13 L 08 S	L / S	PN 315	15	12	M 22 x 1.5	M 20 x 1.5	38.0	27	24	12.0 x 2.0	9.0 x 1.5
DMO NW 13 L 10 S	L / S	PN 315	15	14	M 22 x 1.5	M 22 x 1.5	38.0	27	27	12.0 x 2.0	10.0 x 2.0
DMO NW 13 L 13 S	L / S	PN 315	15	16	M 22 x 1.5	M 24 x 1.5	39.0	27	30	12.0 x 2.0	12.0 x 2.0
DMO NW 13 L 16 S	L / S	PN 315	15	20	M 22 x 1.5	M 30 x 2	44.0	27	36	12.0 x 2.0	16.3 x 2.4

端对接组合接头

DMO

结构形式：双螺母
 连接1：活动端公制螺母
 密封形式：24°锥带O形圈密封
 连接2：活动端公制螺母
 密封形式：24°锥带O形圈密封

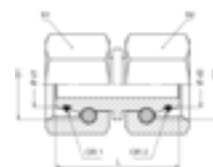

订货号	系列	工作压力 bar	Ød1 mm	Ød2 mm	G1	G2	L mm	S1	S2	OR1	OR2
DMO NW 13 L 20 S	L / S	PN 315	15	25	M 22 x 1.5	M 36 x 2	47.5	27	46	12.0 x 2.0	20.3 x 2.4
DMO NW 16 L 08 S	L / S	PN 315	18	12	M 26 x 1.5	M 20 x 1.5	38.0	32	24	15.0 x 2.0	9.0 x 1.5
DMO NW 16 L 10 S	L / S	PN 315	18	14	M 26 x 1.5	M 22 x 1.5	41.0	32	27	15.0 x 2.0	10.0 x 2.0
DMO NW 16 L 13 S	L / S	PN 315	18	16	M 26 x 1.5	M 24 x 1.5	39.0	32	30	15.0 x 2.0	12.0 x 2.0
DMO NW 16 L 16 S	L / S	PN 315	18	20	M 26 x 1.5	M 30 x 2	44.0	32	36	15.0 x 2.0	16.3 x 2.4
DMO NW 16 L 20 S	L / S	PN 315	18	25	M 26 x 1.5	M 36 x 2	48.0	32	46	15.0 x 2.0	20.3 x 2.4
DMO NW 16 L 25 S	L / S	PN 315	18	30	M 26 x 1.5	M 42 x 2	50.0	32	50	15.0 x 2.0	25.3 x 2.4
DMO NW 20 L 13 S	L / S	PN 160	22	16	M 30 x 2	M 24 x 1.5	42.0	36	30	20.0 x 2.0	12.0 x 2.0
DMO NW 20 L 16 S	L / S	PN 160	22	20	M 30 x 2	M 30 x 2	44.0	36	36	20.0 x 2.0	16.3 x 2.4
DMO NW 20 L 20 S	L / S	PN 160	22	25	M 30 x 2	M 36 x 2	46.0	36	46	20.0 x 2.0	20.3 x 2.4
DMO NW 20 L 25 S	L / S	PN 160	22	30	M 30 x 2	M 42 x 2	52.0	36	50	20.0 x 2.0	25.3 x 2.4
DMO NW 20 L 32 S	L / S	PN 160	22	38	M 30 x 2	M 52 x 2	52.0	36	60	20.0 x 2.0	33.3 x 2.4
DMO NW 25 L 13 S	L / S	PN 160	28	16	M 36 x 2	M 24 x 1.5	46.0	41	30	26.0 x 2.0	12.0 x 2.0
DMO NW 25 L 16 S	L / S	PN 160	28	20	M 36 x 2	M 30 x 2	46.0	41	36	26.0 x 2.0	16.3 x 2.4
DMO NW 25 L 20 S	L / S	PN 160	28	25	M 36 x 2	M 36 x 2	46.0	41	46	26.0 x 2.0	20.3 x 2.4
DMO NW 25 L 25 S	L / S	PN 160	28	30	M 36 x 2	M 42 x 2	52.0	41	50	26.0 x 2.0	25.3 x 2.4
DMO NW 25 L 32 S	L / S	PN 160	28	38	M 36 x 2	M 52 x 2	51.0	41	60	26.0 x 2.0	33.3 x 2.4
DMO NW 32 L 16 S	L / S	PN 160	35	20	M 45 x 2	M 30 x 2	48.0	50	36	32.0 x 2.5	16.3 x 2.4
DMO NW 32 L 20 S	L / S	PN 160	35	25	M 45 x 2	M 36 x 2	48.0	50	46	32.0 x 2.5	20.3 x 2.4
DMO NW 32 L 25 S	L / S	PN 160	35	30	M 45 x 2	M 42 x 2	52.0	50	50	32.0 x 2.5	25.3 x 2.4
DMO NW 32 L 32 S	L / S	PN 160	35	38	M 45 x 2	M 52 x 2	52.0	50	60	32.0 x 2.5	33.3 x 2.4
DMO NW 40 L 25 S	L / S	PN 160	42	30	M 52 x 2	M 42 x 2	52.0	60	50	38.0 x 2.5	25.3 x 2.4
DMO NW 40 L 32 S	L / S	PN 160	42	38	M 52 x 2	M 52 x 2	52.0	60	60	38.0 x 2.5	33.3 x 2.4
DMO NW 03 S	S	PN 630	6	6	M 14 x 1.5	M 14 x 1.5	35.0	17	17	4.0 x 1.5	4.0 x 1.5
DMO NW 03 S 04	S	PN 630	6	8	M 14 x 1.5	M 16 x 1.5	33.0	17	19	4.0 x 1.5	6.0 x 1.5
DMO NW 03 S 06	S	PN 630	6	10	M 14 x 1.5	M 18 x 1.5	32.0	17	22	4.0 x 1.5	7.5 x 1.5
DMO NW 03 S 08	S	PN 630	6	12	M 14 x 1.5	M 20 x 1.5	37.5	17	24	4.0 x 1.5	9.0 x 1.5
DMO NW 04 S	S	PN 630	8	8	M 16 x 1.5	M 16 x 1.5	35.0	19	19	6.0 x 1.5	6.0 x 1.5
DMO NW 04 S 06	S	PN 630	8	10	M 16 x 1.5	M 18 x 1.5	33.0	19	22	6.0 x 1.5	7.5 x 1.5
DMO NW 04 S 08	S	PN 630	8	12	M 16 x 1.5	M 20 x 1.5	36.0	19	24	6.0 x 1.5	9.0 x 1.5
DMO NW 06 S	S	PN 630	10	10	M 18 x 1.5	M 18 x 1.5	39.0	22	22	7.5 x 1.5	7.5 x 1.5
DMO NW 06 S 08	S	PN 630	10	12	M 18 x 1.5	M 20 x 1.5	36.0	22	24	7.5 x 1.5	9.0 x 1.5
DMO NW 06 S 10	S	PN 630	10	14	M 18 x 1.5	M 22 x 1.5	39.0	22	27	7.5 x 1.5	10.0 x 2.0
DMO NW 06 S 13	S	PN 400	10	16	M 18 x 1.5	M 24 x 1.5	39.0	22	30	7.5 x 1.5	12.0 x 2.0
DMO NW 08 S	S	PN 630	12	12	M 20 x 1.5	M 20 x 1.5	40.0	24	24	9.0 x 1.5	9.0 x 1.5
DMO NW 08 S 10	S	PN 630	12	14	M 20 x 1.5	M 22 x 1.5	39.0	24	27	9.0 x 1.5	10.0 x 2.0
DMO NW 08 S 13	S	PN 400	12	16	M 20 x 1.5	M 24 x 1.5	39.0	24	30	9.0 x 1.5	12.0 x 2.0
DMO NW 08 S 16	S	PN 400	12	20	M 20 x 1.5	M 30 x 2	39.0	24	36	9.0 x 1.5	16.3 x 2.4
DMO NW 10 S	S	PN 630	14	14	M 22 x 1.5	M 22 x 1.5	43.0	27	27	10.0 x 2.0	10.0 x 2.0
DMO NW 10 S 13	S	PN 400	14	16	M 22 x 1.5	M 24 x 1.5	39.0	27	30	10.0 x 2.0	12.0 x 2.0
DMO NW 10 S 16	S	PN 400	14	20	M 22 x 1.5	M 30 x 2	44.0	27	36	10.0 x 2.0	16.3 x 2.4
DMO NW 13 S	S	PN 400	16	16	M 24 x 1.5	M 24 x 1.5	44.0	30	30	12.0 x 2.0	12.0 x 2.0
DMO NW 13 S 16	S	PN 400	16	20	M 24 x 1.5	M 30 x 2	44.0	30	36	12.0 x 2.0	16.3 x 2.4
DMO NW 13 S 20	S	PN 400	16	25	M 24 x 1.5	M 36 x 2	46.0	30	46	12.0 x 2.0	20.3 x 2.4
DMO NW 13 S 25	S	PN 400	16	30	M 24 x 1.5	M 42 x 2	52.0	30	50	12.0 x 2.0	25.3 x 2.4
DMO NW 16 S	S	PN 400	20	20	M 30 x 2	M 30 x 2	53.5	36	36	16.3 x 2.4	16.3 x 2.4
DMO NW 16 S 20	S	PN 400	20	25	M 30 x 2	M 36 x 2	46.0	36	46	16.3 x 2.4	20.3 x 2.4
DMO NW 16 S 25	S	PN 400	20	30	M 30 x 2	M 42 x 2	52.0	36	50	16.3 x 2.4	25.3 x 2.4
DMO NW 16 S 32	S	PN 315	20	38	M 30 x 2	M 52 x 2	52.0	36	60	16.3 x 2.4	33.3 x 2.4
DMO NW 20 S	S	PN 400	25	25	M 36 x 2	M 36 x 2	57.5	46	46	20.3 x 2.4	20.3 x 2.4
DMO NW 20 S 25	S	PN 400	25	30	M 36 x 2	M 42 x 2	52.0	46	50	20.3 x 2.4	25.3 x 2.4
DMO NW 20 S 32	S	PN 315	25	38	M 36 x 2	M 52 x 2	52.0	46	60	20.3 x 2.4	33.3 x 2.4
DMO NW 25 S	S	PN 400	30	30	M 42 x 2	M 42 x 2	60.5	50	50	25.3 x 2.4	25.3 x 2.4
DMO NW 25 S 32	S	PN 315	30	38	M 42 x 2	M 52 x 2	52.0	50	60	25.3 x 2.4	33.3 x 2.4
DMO NW 32 S	S	PN 315	38	38	M 52 x 2	M 52 x 2	65.5	60	60	33.3 x 2.4	33.3 x 2.4

系列：LL=特轻系列 L=轻系列 S=重系列

45°端对接组合接头

结构形式: 45°角

连接1: 活动端公制螺母

密封形式: 24°锥带O形圈密封

连接2: 活动端公制螺母

密封形式: 24°锥带O形圈密封

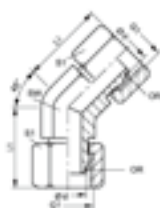

DMO 45



订货号	系列	工作压力 bar	Ød mm	G1	L1 mm	SW mm	S1	OR
DMO 45 NW 04 L	L	PN 400	6	M 12 x 1.5	22.5	14	14	4.0 x 1.5
DMO 45 NW 06 L	L	PN 400	8	M 14 x 1.5	23	14	17	6.0 x 1.5
DMO 45 NW 08 L	L	PN 400	10	M 16 x 1.5	25	19	19	7.5 x 1.5
DMO 45 NW 10 L	L	PN 400	12	M 18 x 1.5	25.5	19	22	9.0 x 1.5
DMO 45 NW 13 L	L	PN 400	15	M 22 x 1.5	27	22	27	12.0 x 2.0
DMO 45 NW 16 L	L	PN 315	18	M 26 x 1.5	30	27	32	15.0 x 2.0
DMO 45 NW 20 L	L	PN 315	22	M 30 x 2	32	30	36	20.0 x 2.0
DMO 45 NW 25 L	L	PN 250	28	M 36 x 2	35	36	41	26.0 x 2.0
DMO 45 NW 32 L	L	PN 250	35	M 45 x 2	39.5	50	50	32.0 x 2.5
DMO 45 NW 40 L	L	PN 250	42	M 52 x 2	42	50	60	38.0 x 2.5
DMO 45 NW 03 S	S	PN 630	6	M 14 x 1.5	23.5	14	17	4.0 x 1.5
DMO 45 NW 04 S	S	PN 630	8	M 16 x 1.5	26.5	19	19	6.0 x 1.5
DMO 45 NW 06 S	S	PN 630	10	M 18 x 1.5	27	19	22	7.5 x 1.5
DMO 45 NW 08 S	S	PN 630	12	M 20 x 1.5	27.5	19	24	9.0 x 1.5
DMO 45 NW 13 S	S	PN 400	16	M 24 x 1.5	31.5	27	30	12.0 x 2.0
DMO 45 NW 16 S	S	PN 400	20	M 30 x 2	36	30	36	16.3 x 2.4
DMO 45 NW 20 S	S	PN 400	25	M 36 x 2	40.5	36	46	20.3 x 2.4
DMO 45 NW 25 S	S	PN 400	30	M 42 x 2	44.5	50	50	25.3 x 2.4
DMO 45 NW 32 S	S	PN 315	38	M 52 x 2	50.5	50	60	33.3 x 2.4

系列: LL=特轻系列 L=轻系列 S=重系列

可调向端通管接头(45°角)

结构形式: 45°角

连接1: BSP标准外螺纹

密封形式: O形圈和支撑环 (H型密封)

连接2: 公制外螺纹

密封形式: 24°内锥面密封

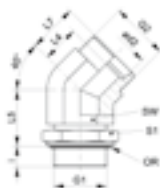

XEWORK 45



订货号	系列	工作压力 bar	Ød2 mm	G1	管外径 mm	G2	i mm	L4 mm	L5 mm	L7 mm	SW mm	S1	OR
XEWORK 45 NW 04 HL	L	PN 315	6	G 1/8" -28	6	M 12 x 1.5	7	9	21	16	14	14	7.65 x 1.78
XEWORK 45 NW 06 HL	L	PN 315	8	G 1/4" -19	8	M 14 x 1.5	9	12	20	19	14	19	10.78 x 2.62
XEWORK 45 NW 08 HL	L	PN 315	10	G 1/4" -19	10	M 16 x 1.5	9	12	25	19	19	19	10.78 x 2.62
XEWORK 45 NW 10 HL	L	PN 250	12	G 3/8" -19	12	M 18 x 1.5	9	14	28	21	19	22	13.94 x 2.62
XEWORK 45 NW 13 HL	L	PN 250	15	G 1/2" -14	15	M 22 x 1.5	13	17	26	24	22	27	17.86 x 2.62
XEWORK 45 NW 16 HL	L	PN 250	18	G 1/2" -14	18	M 26 x 1.5	13	17	32	24	27	27	17.86 x 2.62
XEWORK 45 NW 20 HL	L	PN 160	22	G 3/4" -14	22	M 30 x 2	13	19	37	26	30	36	23.47 x 2.62
XEWORK 45 NW 20 HL 27	L	PN 160	22	G 3/4" -14	22	M 27 x 2	13	19	37	26	30	36	23.47 x 2.62
XEWORK 45 NW 25 HL	L	PN 160	28	G 1" -11	28	M 36 x 2	15	23	37	31	36	41	29.75 x 3.53
XEWORK 45 NW 32 HL	L	PN 160	35	G 1.1/4" -11	35	M 45 x 2	15	27	39	37	50	50	37.69 x 3.53
XEWORK 45 NW 40 HL	L	PN 160	42	G 1.1/2" -11	42	M 52 x 2	15	26	39	37	50	55	44.04 x 3.53
XEWORK 45 NW 03 HS	S	PN 315	6	G 1/4" -19	6	M 14 x 1.5	9	9	19	16	14	19	10.78 x 2.62
XEWORK 45 NW 04 HS	S	PN 315	8	G 1/4" -19	8	M 16 x 1.5	9	12	23	19	19	19	10.78 x 2.62
XEWORK 45 NW 06 HS	S	PN 250	10	G 3/8" -19	10	M 18 x 1.5	9	13	25	21	19	22	13.94 x 2.62
XEWORK 45 NW 08 HS	S	PN 250	12	G 3/8" -19	12	M 20 x 1.5	9	17	25	24	22	22	13.94 x 2.62
XEWORK 45 NW 10 HS	S	PN 250	14	G 1/2" -14	14	M 22 x 1.5	13	16	31	24	27	27	17.86 x 2.62
XEWORK 45 NW 13 HS	S	PN 250	16	G 1/2" -14	16	M 24 x 1.5	13	16	31	24	27	27	17.86 x 2.62
XEWORK 45 NW 16 HS	S	PN 250	20	G 3/4" -14	20	M 30 x 2	12	16	34	27	30	36	23.47 x 2.62
XEWORK 45 NW 20 HS	S	PN 250	25	G 1" -11	25	M 36 x 2	14	19	37	31	36	41	29.74 x 3.53
XEWORK 45 NW 25 HS	S	PN 160	30	G 1.1/4" -11	30	M 42 x 2	15	24	38	37	50	50	37.69 x 3.53
XEWORK 45 NW 32 HS	S	PN 160	38	G 1.1/2" -11	38	M 52 x 2	15	21	38	37	50	55	44.04 x 3.53

系列: LL=特轻系列 L=轻系列 S=重系列; G1=接口螺纹 G2=接口螺纹

可调向端通管接头(45°角)

XEWOR 45

结构形式: 45°角

连接1: BSP标准外螺纹

密封形式: G型

连接2: 公制外螺纹

密封形式: 24°内锥面密封



订货号	系列	工作压力 bar	Ød2 mm	G1	管外径Ø mm	G2	i mm	L4 mm	L5 mm	L7 mm	SW mm	S1	OR
XEWOR 45 NW 04 HL	L	PN 315	6	G 1/8" -28	6	M 12 x 1.5	8	9	21	16.0	14	14	8.0 x 1.5
XEWOR 45 NW 06 HL	L	PN 315	8	G 1/4" -19	8	M 14 x 1.5	9	12	20	19.0	14	19	10.77 x 2.62
XEWOR 45 NW 08 HL	L	PN 315	10	G 1/4" -19	10	M 16 x 1.5	9	12	25	19.0	19	19	10.77 x 2.62
XEWOR 45 NW 10 HL	L	PN 250	12	G 3/8" -19	12	M 18 x 1.5	9	14	28	21.0	19	22	13.94 x 2.62
XEWOR 45 NW 13 HL	L	PN 250	15	G 1/2" -14	15	M 22 x 1.5	13	17	26	24.0	22	27	17.86 x 2.62
XEWOR 45 NW 16 HL	L	PN 250	18	G 1/2" -14	18	M 26 x 1.5	13	17	32	24.5	27	27	17.86 x 2.62
XEWOR 45 NW 20 HL	L	PN 160	22	G 3/4" -14	22	M 30 x 2	13	19	37	26.5	30	36	23.47 x 2.62
XEWOR 45 NW 25 HL	L	PN 160	28	G 1" -11	28	M 36 x 2	15	23	37	30.5	36	41	29.74 x 3.53
XEWOR 45 NW 32 HL	L	PN 160	35	G 1.1/4" -11	35	M 45 x 2	15	27	39	37.5	50	50	37.69 x 3.53
XEWOR 45 NW 40 HL	L	PN 160	42	G 1.1/2" -11	42	M 52 x 2	15	26	39	37.0	50	55	44.04 x 3.53
XEWOR 45 NW 03 HS	S	PN 315	6	G 1/4" -19	6	M 14 x 1.5	9	9	19	16.0	14	19	10.77 x 2.62
XEWOR 45 NW 04 HS	S	PN 315	8	G 1/4" -19	8	M 16 x 1.5	9	12	23	19.0	19	19	10.77 x 2.62
XEWOR 45 NW 06 HS	S	PN 250	10	G 3/8" -19	10	M 16 x 1.5	9	13	25	20.5	19	22	13.94 x 2.62
XEWOR 45 NW 08 HS	S	PN 250	12	G 3/8" -19	12	M 20 x 1.5	9	17	25	24.5	22	22	13.94 x 2.62
XEWOR 45 NW 10 HS	S	PN 250	14	G 1/2" -14	14	M 22 x 1.5	13	16	31	24.5	27	27	17.86 x 2.62
XEWOR 45 NW 13 HS	S	PN 250	16	G 1/2" -14	16	M 24 x 1.5	13	16	31	24.5	27	27	17.86 x 2.62
XEWOR 45 NW 16 HS	S	PN 250	20	G 3/4" -14	20	M 30 x 2	12	16	34	26.5	30	36	23.47 x 2.62
XEWOR 45 NW 20 HS	S	PN 250	25	G 1" -11	25	M 36 x 2	14	19	37	31.0	36	41	29.74 x 3.53
XEWOR 45 NW 25 HS	S	PN 160	30	G 1.1/4" -11	30	M 42 x 2	15	24	38	37.5	50	50	37.69 x 3.53
XEWOR 45 NW 32 HS	S	PN 160	38	G 1.1/2" -11	38	M 52 x 2	15	21	38	37.0	50	55	44.04 x 3.53

系列: LL=特轻系列 L=轻系列 S=重系列; G1=接口螺纹 G2=接口螺纹

可调向端通管接头(45°角)

XEWOMK 45

结构形式: 45°角

连接1: 公制圆柱管螺纹

密封形式: O形圈和支撑环(H型密封)

连接2: 公制外螺纹

密封形式: 24°内锥面密封

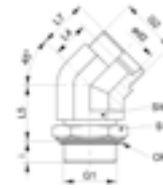

订货号	系列	工作压力 bar	Ød2 mm	G1	管外径Ø mm	G2	i mm	L4 mm	L5 mm	L7 mm	SW mm	S1	OR
XEWOMK 45 NW 04 HL	L	PN 315	6	M 10 x 1	6	M 12 x 1.5	8	9	20	16	14	13	8.1 x 1.6
XEWOMK 45 NW 06 HL	L	PN 315	8	M 12 x 1.5	8	M 14 x 1.5	11	12	18	19	14	17	9.3 x 2.4
XEWOMK 45 NW 08 HL	L	PN 315	10	M 14 x 1.5	10	M 16 x 1.5	11	12	22	19	19	17	11.3 x 2.4
XEWOMK 45 NW 10 HL	L	PN 315	12	M 16 x 1.5	12	M 18 x 1.5	11	14	23	21	19	19	13.3 x 2.4
XEWOMK 45 NW 13 HL	L	PN 315	15	M 18 x 1.5	15	M 22 x 1.5	12	17	23	24	22	22	15.3 x 2.4
XEWOMK 45 NW 16 HL	L	PN 250	18	M 22 x 1.5	18	M 26 x 1.5	12	17	30	24	27	27	19.3 x 2.4
XEWOMK 45 NW 20 HL	L	PN 160	22	M 26 x 1.5	22	M 30 x 2	16	19	30	26	27	32	23.3 x 2.4
XEWOMK 45 NW20 HL27	L	PN 160	22	M 27 x 2	22	M 30 x 2	15	19	30	26	30	32	23.6 x 2.9
XEWOMK 45 NW 25 HL	L	PN 160	28	M 33 x 2	28	M 36 x 2	15	23	34	31	36	38	29.5 x 3.0
XEWOMK 45 NW 32 HL	L	PN 160	35	M 42 x 2	35	M 45 x 2	15	27	36	37	50	50	38.0 x 3.0
XEWOMK 45 NW 40 HL	L	PN 160	42	M 48 x 2	42	M 52 x 2	17	26	36	37	50	55	44.5 x 3.0
XEWOMK 45 NW 03 HS	S	PN 315	6	M 12 x 1.5	6	M 14 x 1.5	11	9	18	16	14	17	9.3 x 2.4
XEWOMK 45 NW 04 HS	S	PN 315	8	M 14 x 1.5	8	M 16 x 1.5	11	12	18	19	19	17	11.3 x 2.4
XEWOMK 45 NW 06 HS	S	PN 315	10	M 16 x 1.5	10	M 18 x 1.5	12	13	22	21	19	19	13.3 x 2.4
XEWOMK 45 NW 08 HS	S	PN 315	12	M 18 x 1.5	12	M 20 x 1.5	14	17	23	24	22	22	15.3 x 2.4
XEWOMK 45 NW 10 HS	S	PN 250	14	M 20 x 1.5	14	M 22 x 1.5	14	16	30	24	27	27	17.3 x 2.4
XEWOMK 45 NW 13 HS	S	PN 250	16	M 22 x 1.5	16	M 24 x 1.5	14	16	30	24	27	27	19.3 x 2.4
XEWOMK 45 NW 16 HS	S	PN 250	20	M 27 x 2	20	M 30 x 2	18	16	33	27	30	32	23.6 x 2.9
XEWOMK 45 NW 20 HS	S	PN 160	25	M 33 x 2	25	M 36 x 2	18	19	35	31	38	36	29.5 x 3.0
XEWOMK 45 NW 25 HS	S	PN 160	30	M 42 x 2	30	M 42 x 2	18	24	36	37	50	50	38.0 x 3.0
XEWOMK 45 NW 32 HS	S	PN 160	38	M 48 x 2	38	M 52 x 2	21	21	36	37	50	55	44.5 x 3.0

系列: LL=特轻系列 L=轻系列 S=重系列; G1=接口螺纹 G2=接口螺纹

可调向端通管接头(45°角)

XEWOM 45

结构形式: 45°角

连接1: 公制圆柱管螺纹

密封形式: F型

连接2: 公制外螺纹

密封形式: 24°内锥面密封

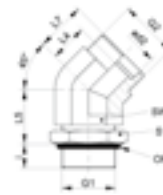

订货号	系列	工作压力 bar	Ød2 mm	G1	管外径Ø mm	G2	i mm	L4 mm	L5 mm	L7 mm	SW mm	S1	OR
XEWOM 45 NW 04 HL	L	PN 315	6	M 10 x 1	6	M 12 x 1.5	8	9	20	16	14	14	8.1 x 1.6
XEWOM 45 NW 06 HL	L	PN 315	8	M 12 x 1.5	8	M 14 x 1.5	11	12	18	19	14	17	9.3 x 2.4
XEWOM 45 NW 08 HL	L	PN 315	10	M 14 x 1.5	10	M 16 x 1.5	11	12	22	19	19	19	11.3 x 2.4
XEWOM 45 NW 10 HL	L	PN 315	12	M 16 x 1.5	12	M 18 x 1.5	11	14	23	21	19	22	13.3 x 2.4
XEWOM 45 NW 13 HL	L	PN 315	15	M 18 x 1.5	15	M 22 x 1.5	12	17	23	24	22	24	15.3 x 2.4
XEWOM 45 NW 16 HL	L	PN 315	18	M 22 x 1.5	18	M 26 x 1.5	12	17	30	24	27	27	19.3 x 2.4
XEWOM 45 NW 20 HL 27	L	PN 160	22	M 27 x 2	22	M 30 x 2	15	19	30	26	30	32	23.6 x 2.9
XEWOM 45 NW 25 HL	L	PN 160	28	M 33 x 2	28	M 36 x 2	15	23	34	31	36	41	29.5 x 3.0
XEWOM 45 NW 32 HL	L	PN 160	35	M 42 x 2	35	M 45 x 2	15	27	36	37	50	50	38.0 x 3.0
XEWOM 45 NW 40 HL	L	PN 160	42	M 48 x 2	42	M 52 x 2	17	26	36	37	50	55	44.5 x 3.0
XEWOM 45 NW 03 HS	S	PN 400	6	M 12 x 1.5	6	M 14 x 1.5	11	9	18	16	14	17	9.3 x 2.4
XEWOM 45 NW 04 HS	S	PN 400	8	M 14 x 1.5	8	M 16 x 1.5	11	12	18	19	19	19	11.3 x 2.4
XEWOM 45 NW 06 HS	S	PN 400	10	M 16 x 1.5	10	M 18 x 1.5	12	13	22	21	19	22	13.3 x 2.4
XEWOM 45 NW 08 HS	S	PN 400	12	M 18 x 1.5	12	M 20 x 1.5	14	17	23	24	22	24	15.3 x 2.4
XEWOM 45 NW 10 HS	S	PN 400	14	M 20 x 1.5	14	M 22 x 1.5	14	16	23	24	27	27	17.3 x 2.4
XEWOM 45 NW 13 HS	S	PN 400	16	M 22 x 1.5	16	M 24 x 1.5	14	16	20	24	27	27	19.3 x 2.4
XEWOM 45 NW 16 HS	S	PN 400	20	M 27 x 2	20	M 30 x 2	18	16	33	27	30	32	23.6 x 2.9
XEWOM 45 NW 20 HS	S	PN 315	25	M 33 x 2	25	M 36 x 2	18	19	35	31	36	41	29.5 x 3.0
XEWOM 45 NW 25 HS	S	PN 250	30	M 42 x 2	30	M 42 x 2	18	24	36	37	50	50	38.0 x 3.0
XEWOM 45 NW 32 HS	S	PN 200	38	M 42 x 2	38	M 52 x 2	21	21	36	37	50	55	38.0 x 3.0

系列: LL=特轻系列 L=轻系列 S=重系列; G1=接口螺纹 G2=接口螺纹

可调向端直角管接头

XEWORK

结构形式: 90°角

连接1: BSP标准外螺纹

密封形式: O形圈和支撑环 (H型密封)

连接2: 公制外螺纹

密封形式: 24°内锥面密封

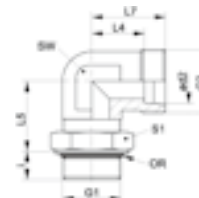

订货号	系列	工作压力 bar	Ød2 mm	G1	管外径Ø mm	G2	i mm	L4 mm	L5 mm	L7 mm	SW mm	S1	OR
XEWORK 04 LL	LL	PN 250	4	G 1/8" -28	4	M 8 x 1	7.1	11.3	20	15	11	14	7.65 x 1.78
XEWORK 06 LL	LL	PN 250	6	G 1/8" -28	6	M 10 x 1	7.1	11.3	20	15	11	14	7.65 x 1.78
XEWORK NW 04 HL	L	PN 315	6	G 1/8" -28	6	M 12 x 1.5	7.0	14.0	19	21	14	14	7.65 x 1.78
XEWORK NW 06 HL	L	PN 315	8	G 1/4" -19	8	M 14 x 1.5	9.0	16.0	23	23	14	19	10.78 x 2.62
XEWORK NW 08 HL	L	PN 315	10	G 1/4" -19	10	M 16 x 1.5	9.0	17.0	25	24	19	19	10.77 x 2.62
XEWORK NW 10 HL	L	PN 250	12	G 3/8" -19	12	M 18 x 1.5	9.0	19.0	28	26	19	22	13.94 x 2.62
XEWORK NW 13 HL	L	PN 250	15	G 1/2" -14	15	M 22 x 1.5	13.0	21.0	30	28	22	27	17.86 x 2.62
XEWORK NW 16 HL	L	PN 250	18	G 1/2" -14	18	M 26 x 1.5	13.0	24.0	36	31	27	27	17.86 x 2.62
XEWORK NW 20 HL	L	PN 160	22	G 3/4" -14	22	M 30 x 2	13.0	28.0	36	35	30	36	23.47 x 2.62
XEWORK NW 25 HL	L	PN 160	28	G 1" -11	28	M 36 x 2	15.0	31.0	44	38	36	41	29.74 x 3.53
XEWORK NW 32 HL	L	PN 160	35	G 1.1/4" -11	35	M 45 x 2	15.0	38.0	50	48	50	50	37.69 x 3.53
XEWORK NW 40 HL	L	PN 160	42	G 1.1/2" -11	42	M 52 x 2	15.0	38.0	52	49	50	55	44.04 x 3.53
XEWORK NW 03 HS	S	PN 315	6	G 1/4" -19	6	M 14 x 1.5	9.0	15.0	23	22	14	19	10.77 x 2.62
XEWORK NW 04 HS	S	PN 315	8	G 1/4" -19	8	M 16 x 1.5	9.0	17.0	27	24	19	19	10.77 x 2.62
XEWORK NW 06 HS	S	PN 250	10	G 3/8" -19	10	M 18 x 1.5	9.0	18.0	29	25	19	22	13.94 x 2.62
XEWORK NW 08 HS	S	PN 250	12	G 3/8" -19	12	M 20 x 1.5	9.0	22.0	29	29	22	22	13.94 x 2.62
XEWORK NW 10 HS	S	PN 250	14	G 1/2" -14	14	M 22 x 1.5	13.0	25.0	36	33	27	27	18.00 x 3.00
XEWORK NW 13 HS	S	PN 250	16	G 1/2" -14	16	M 24 x 1.5	13.0	25.0	36	33	27	27	17.86 x 2.62
XEWORK NW 16 HS	S	PN 250	20	G 3/4" -14	20	M 30 x 2	12.0	28.0	39	38	30	36	23.47 x 2.62
XEWORK NW 20 HS	S	PN 250	25	G 1" -11	25	M 36 x 2	14.0	30.0	44	42	36	41	29.74 x 3.53
XEWORK NW 25 HS	S	PN 160	30	G 1.1/4" -11	30	M 42 x 2	15.0	36.0	49	49	50	50	37.69 x 3.53
XEWORK NW 32 HS	S	PN 160	38	G 1.1/2" -11	38	M 52 x 2	15.0	34.0	55	50	50	55	44.04 x 3.53

系列: LL=特轻系列 L=轻系列 S=重系列; G1=接口螺纹 G2=接口螺纹

可调向端直角管接头

结构形式: 90°角
 连接1: BSP标准外螺纹
 密封形式: G型
 连接2: 公制外螺纹
 密封形式: 24°内锥面密封

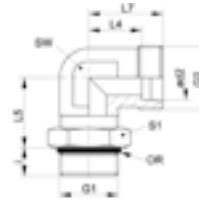

XEWOR



订货号	系列	工作压力 bar	Ød2 mm	G1	管外径Ø mm	G2	i mm	L4 mm	L5 mm	L7 mm	SW mm	S1	OR
XEWOR NW 04 HL	L	PN 250	6	G 1/8" -28	6	M 12 x 1.5	8	12.0	21.5	19	12	14	8.0 x 1.5
XEWOR NW 06 HL	L	PN 250	8	G 1/4" -19	8	M 14 x 1.5	12	14.0	26.0	21	14	19	10.0 x 2.0
XEWOR NW 06 HL 3/8	L	PN 250	8	G 3/8" -19	8	M 14 x 1.5	12	17.0	28.5	24	17	22	14.0 x 2.5
XEWOR NW 08 HL	L	PN 250	10	G 1/4" -19	10	M 16 x 1.5	12	15.0	26.0	22	14	19	10.0 x 2.0
XEWOR NW 10 HL	L	PN 250	12	G 3/8" -19	12	M 18 x 1.5	12	17.0	28.5	24	17	22	14.0 x 2.5
XEWOR NW 13 HL	L	PN 250	15	G 1/2" -14	15	M 22 x 1.5	14	21.0	33.5	28	19	27	18.0 x 3.0
XEWOR NW 16 HL	L	PN 160	18	G 1/2" -14	18	M 26 x 1.5	14	23.5	36.5	31	24	27	18.0 x 3.0
XEWOR NW 20 HL	L	PN 160	22	G 3/4" -14	22	M 30 x 2	16	27.5	41.0	35	27	32	23.5 x 3.0
XEWOR NW 25 HL	L	PN 100	28	G 1" -11	28	M 36 x 2	18	30.5	45.0	38	36	41	29.0 x 3.5
XEWOR NW 32 HL	L	PN 100	35	G 1 1/4" -11	35	M 45 x 2	20	34.5	50.0	45	41	50	38.0 x 3.5
XEWOR NW 40 HL	L	PN 100	42	G 1 1/2" -11	42	M 52 x 2	22	40.0	56.0	51	50	55	44.0 x 3.5
XEWOR NW 03 HS	S	PN 630	6	G 1/4" -19	6	M 14 x 1.5	12	15.0	26.0	22	12	19	10.0 x 2.0
XEWOR NW 04 HS	S	PN 630	8	G 1/4" -19	8	M 16 x 1.5	12	17.0	27.0	24	14	19	10.0 x 2.0
XEWOR NW 06 HS	S	PN 630	10	G 3/8" -19	10	M 18 x 1.5	12	17.5	28.5	25	17	22	14.0 x 2.5
XEWOR NW 08 HS	S	PN 630	12	G 3/8" -19	12	M 20 x 1.5	12	21.5	32.5	29	19	22	14.0 x 2.5
XEWOR NW 10 HS	S	PN 630	14	G 1/2" -14	14	M 22 x 1.5	14	22.0	33.5	30	19	27	18.0 x 3.0
XEWOR NW 13 HS	S	PN 400	16	G 1/2" -14	16	M 24 x 1.5	14	24.5	36.5	33	24	27	18.0 x 3.0
XEWOR NW 16 HS	S	PN 400	20	G 3/4" -14	20	M 30 x 2	16	26.5	41.0	39	27	32	23.5 x 3.0
XEWOR NW 20 HS	S	PN 400	25	G 1" -11	25	M 36 x 2	18	30.0	45.0	42	36	41	29.0 x 3.5
XEWOR NW 25 HS	S	PN 250	30	G 1 1/4" -11	30	M 42 x 2	20	35.5	50.0	49	41	50	38.0 x 3.5
XEWOR NW 32 HS	S	PN 250	38	G 1 1/2" -11	38	M 52 x 2	22	41.0	56.0	57	50	55	44.0 x 3.5

系列: LL=特轻系列 L=轻系列 S=重系列; G1=接口螺纹 G2=接口螺纹

可调向端直角管接头

结构形式: 90°角
 连接1: 公制圆柱管螺纹
 密封形式: O形圈和支撑环 (H型密封)
 连接2: 公制外螺纹
 密封形式: 24°内锥面密封

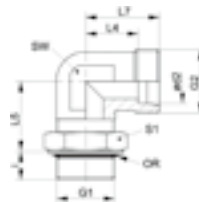

XEWOMK



订货号	系列	工作压力 bar	Ød2 mm	G1	管外径Ø mm	G2	i mm	L4 mm	L5 mm	L7 mm	SW mm	S1	OR
XEWOMK NW 04 HL	L	PN 315	6	M 10 x 1	6	M 12 x 1.5	7	14	20	21	14	13	8.1 x 1.6
XEWOMK NW 06 HL	L	PN 315	8	M 12 x 1.5	8	M 14 x 1.5	10	16	22	23	14	17	9.3 x 2.4
XEWOMK NW 08 HL	L	PN 315	10	M 14 x 1.5	10	M 16 x 1.5	10	17	24	24	19	17	11.3 x 2.4
XEWOMK NW 10 HL	L	PN 315	12	M 16 x 1.5	12	M 18 x 1.5	10	19	25	26	19	19	13.3 x 2.4
XEWOMK NW 13 HL	L	PN 315	15	M 18 x 1.5	15	M 22 x 1.5	11	21	31	28	22	22	15.3 x 2.4
XEWOMK NW 16 HL	L	PN 250	18	M 22 x 1.5	18	M 26 x 1.5	12	24	33	31	27	27	19.3 x 2.4
XEWOMK NW 20 HL	L	PN 160	22	M 26 x 1.5	22	M 30 x 2	14	28	36	35	30	32	23.5 x 2.6
XEWOMK NW 20 HL 27	L	PN 160	22	M 27 x 2	22	M 30 x 2	14	28	36	35	30	32	23.6 x 2.9
XEWOMK NW 25 HL	L	PN 160	28	M 33 x 2	28	M 36 x 2	14	31	39	38	36	38	29.5 x 3.0
XEWOMK NW 32 HL	L	PN 160	35	M 42 x 2	35	M 42 x 2	14	38	49	48	50	50	38.0 x 3.0
XEWOMK NW 40 HL	L	PN 160	42	M 48 x 2	42	M 52 x 2	16	38	50	49	50	55	44.5 x 3.0
XEWOMK NW 03 HS	S	PN 315	6	M 12 x 1.5	6	M 14 x 1.5	10	15	22	22	14	17	9.3 x 2.4
XEWOMK NW 04 HS	S	PN 315	8	M 14 x 1.5	8	M 16 x 1.5	10	17	26	24	19	17	11.3 x 2.4
XEWOMK NW 06 HS	S	PN 315	10	M 16 x 1.5	10	M 18 x 1.5	11	18	27	25	19	19	13.3 x 2.4
XEWOMK NW 08 HS	S	PN 315	12	M 18 x 1.5	12	M 20 x 1.5	12	22	31	29	22	22	15.3 x 2.4
XEWOMK NW 10 HS	S	PN 250	14	M 20 x 1.5	14	M 22 x 1.5	14	25	36	33	27	27	17.3 x 2.4
XEWOMK NW 13 HS	S	PN 250	16	M 22 x 1.5	16	M 24 x 1.5	14	25	36	33	27	27	19.3 x 2.4
XEWOMK NW 16 HS	S	PN 250	20	M 27 x 2	20	M 30 x 2	16	28	39	38	30	32	23.6 x 2.9
XEWOMK NW 20 HS	S	PN 160	25	M 33 x 2	25	M 36 x 2	16	30	44	42	36	38	29.5 x 3.0
XEWOMK NW 25 HS	S	PN 160	30	M 42 x 2	30	M 42 x 2	17	36	51	49	50	50	38.0 x 3.0
XEWOMK NW 32 HS	S	PN 160	38	M 48 x 2	38	M 52 x 2	19	34	54	50	50	55	44.5 x 3.0

系列: LL=特轻系列 L=轻系列 S=重系列; G1=接口螺纹 G2=接口螺纹

可调向端直角管接头

结构形式: 90°角

连接1: 公制圆柱管螺纹

密封形式: F型

连接2: 公制外螺纹

密封形式: 24°内锥面密封

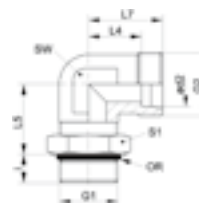

XEWOM



订货号	系列	工作压力 bar	Ød2 mm	G1	管外径Ø mm	G2	i mm	L4 mm	L5 mm	L7 mm	SW mm	S1	OR
XEWOM 04 LL	LL	PN 100	4	M 8 x 1	4	M 8 x 1	7.1	11.3	19.8	15	12	12	6.1 x 1.6
XEWOM 04 LL 10	LL	PN 100	4	M 10 x 1	4	M 8 x 1	7.1	11.3	19.8	15	11	14	8.0 x 1.5
XEWOM 06 LL	LL	PN 100	6	M 10 x 1	6	M 10 x 1	7.1	9.8	19.8	15	14	14	8.0 x 1.5
XEWOM 06 LL 12-1.5	LL	PN 100	6	M 12 x 1.5	6	M 10 x 1	9.6	12.8	23.2	18	14	17	9.3 x 2.4
XEWOM NW 04 HL	L	PN 250	6	M 10 x 1	6	M 12 x 1.5	7.0	14.0	20.0	21	14	14	8.0 x 1.5
XEWOM NW 06 HL	L	PN 250	8	M 12 x 1.5	8	M 14 x 1.5	10.0	16.0	22.0	23	14	17	9.3 x 2.4
XEWOM NW 08 HL	L	PN 250	10	M 14 x 1.5	10	M 16 x 1.5	10.0	17.0	25.0	24	19	19	11.3 x 2.4
XEWOM NW 10 HL	L	PN 250	12	M 16 x 1.5	12	M 18 x 1.5	10.0	19.0	26.0	26	19	22	13.3 x 2.4
XEWOM NW 13 HL	L	PN 250	15	M 18 x 1.5	15	M 22 x 1.5	11.0	21.0	30.0	28	22	24	15.3 x 2.4
XEWOM NW 13 HL 22	L	PN 315	15	M 22 x 1.5	15	M 22 x 1.5	12.0	21.0	33.0	24	22	27	17.3 x 2.4
XEWOM NW 16 HL	L	PN 160	18	M 22 x 1.5	18	M 26 x 1.5	12.0	24.0	33.0	31	27	27	19.3 x 2.4
XEWOM NW 20 HL	L	PN 160	22	M 26 x 1.5	22	M 30 x 2	14.0	28.0	34.0	35	27	32	23.3 x 2.4
XEWOM NW 20 HL 27	L	PN 160	22	M 27x2	22	M 30x2	14.0	28.0	35.0	35	30	32	23.6 x 2.9
XEWOM NW 25 HL	L	PN 100	28	M 33 x 2	28	M 36 x 2	14.0	31.0	38.0	38	36	41	29.5 x 3.0
XEWOM NW 32 HL	L	PN 100	35	M 42 x 2	35	M 45 x 2	14.0	38.0	48.0	48	50	50	38.0 x 3.0
XEWOM NW 40 HL	L	PN 100	42	M 48 x 2	42	M 52 x 2	16.0	38.0	49.0	49	50	55	44.5 x 3.0
XEWOM NW 03 HS	S	PN 630	6	M 12 x 1.5	6	M 14 x 1.5	10.0	15.0	22.0	22	14	17	9.3 x 2.4
XEWOM NW 04 HS	S	PN 630	8	M 14 X 1.5	8	M 15 x 1.5	10.0	17.0	26.0	24	19	19	11.3 x 2.4
XEWOM NW 06 HS	S	PN 630	10	M 16 x 1.5	10	M 18 x 1.5	11.0	18.0	27.0	25	19	22	13.3 x 2.4
XEWOM NW 08 HS	S	PN 630	12	M 18 x 1.5	12	M 20 x 1.5	12.0	22.0	31.0	29	22	24	15.3 x 2.4
XEWOM NW 10 HS	S	PN 630	14	M 20 x 1.5	14	M 22 x 1.5	14.0	22.0	34.0	31	27	27	17.3 x 2.4
XEWOM NW 13 HS	S	PN 400	16	M 22 x 1.5	16	M 24 x 1.5	14.0	25.0	35.0	33	27	27	19.3 x 2.4
XEWOM NW 16 HS	S	PN 400	20	M 27 x 2	20	M 30 x 2	16.0	28.0	39.0	38	30	32	23.5 x 3.0
XEWOM NW 20 HS	S	PN 315	25	M 33 x 2	25	M 36 x 2	16.0	30.0	44.0	42	36	41	29.5 x 3.0
XEWOM NW 25 HS	S	PN 250	30	M 42 x 2	30	M 42 x 2	17.0	36.0	51.0	49	50	50	38.0 x 3.0
XEWOM NW 32 HS	S	PN 200	38	M 48 x 2	38	M 52 x 2	19.0	34.0	54.0	50	50	55	44.5 x 3.0

系列: LL=特轻系列 L=轻系列 S=重系列; G1=接口螺纹 G2=接口螺纹

可调向端直角管接头

结构形式: 90°角

连接1: UN/UNF外螺纹

密封形式: F型

连接2: 公制外螺纹

密封形式: 24°内锥面密封

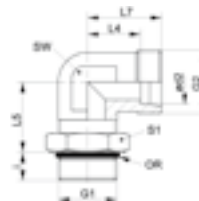

XEWO



订货号	系列	工作压力 bar	Ød2 mm	G1	G2	i mm	L4 mm	L5 mm	L7 mm	SW mm	S1	OR
XEWO NW04 HL 7/16	L	PN 315	6	7/16" UNF	M 12 x 1.5	10	14	19	21	14	14	8.92 x 1.83
XEWO NW06 HL 7/16	L	PN 315	8	7/16" UNF	M 14 x 1.5	10	16	19	23	14	14	8.92 x 1.83
XEWO NW06 HL 1/2	L	PN 315	8	1/2" UNF	M 14 x 1.5	10	16	19	24	14	17	10.52 x 1.83
XEWO NW06 HL 9/16	L	PN 315	8	9/16" UNF	M 14 x 1.5	10	16	24	24	19	17	11.90 x 1.98
XEWO NW08 HL 9/16	L	PN 315	10	9/16" UNF	M 16 x 1.5	10	17	24	24	19	17	11.90 x 1.98
XEWO NW10 HL 9/16	L	PN 315	12	9/16" UNF	M 18 x 1.5	11	19	25	26	19	17	11.90 x 1.98
XEWO NW10 HL 3/4	L	PN 315	12	3/4" UNF	M 18 x 1.5	13	19	25	26	19	22	16.36 x 2.20
XEWO NW13 HL 3/4	L	PN 315	15	3/4" UNF	M 22 x 1.5	13	21	28	28	22	22	16.36 x 2.20
XEWO NW13 HL 7/8	L	PN 315	15	7/8" UNF	M 22 x 1.5	15	21	28	28	22	27	19.18 x 2.46
XEWO NW16 HL 7/8	L	PN 315	18	7/8" UNF	M 26 x 1.5	15	24	32	31	27	27	19.18 x 2.46
XEWO NW16 HL 1 1/16	L	PN 315	18	1.1/16" UN	M 26 x 1.5	17	24	32	31	30	32	23.47 x 2.95
XEWO NW20 HL 1 1/16	L	PN 160	22	1.1/16" UN	M 30 x 2	17	28	35	35	30	32	23.47 x 2.95
XEWO NW25 HL 1 5/16	L	PN 160	28	1.5/16" UN	M 36 x 2	17	31	42	38	36	41	29.74 x 2.95
XEWO NW32 HL 1 5/8	L	PN 160	35	1.5/8" UN	M 45 x 2	17	38	46	48	50	50	37.47 x 3.00
XEWO NW40 HL 1 7/8	L	PN 160	42	1.7/8" UN	M 52 x 2	17	38	47	49	50	55	43.69 x 3.00
XEWO NW03 HS 7/16	S	PN 400	6	7/16" UNF	M 14 x 1.5	12	15	20	22	14	14	8.92 x 1.83
XEWO NW04 HS 1/2	S	PN 400	8	1/2" UNF	M 16 x 1.5	11	17	22	25	14	17	10.52 x 1.83

可调向端直角管接头

结构形式: 90°角
 连接1: UN/UNF外螺纹
 密封形式: F型
 连接2: 公制外螺纹
 密封形式: 24°内锥面密封

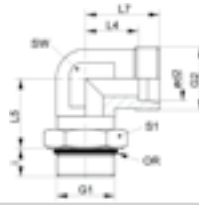

XEWO

订货号	系列	工作压力 bar	Ød2 mm	G1	G2	i mm	L4 mm	L5 mm	L7 mm	SW mm	S1	OR
XEWO NW04 HS 9/16	S	PN 400	8	9/16" UNF	M 16 x 1.5	12	17	25	24	19	17	11.90 x 1.98
XEWO NW06 HS 9/16	S	PN 400	10	9/16" UNF	M 18 x 1.5	12	18	26	25	19	17	11.90 x 1.98
XEWO NW08 HS 3/4	S	PN 400	12	3/4" UNF	M 20 x 1.5	14	22	30	29	22	22	16.36 x 2.20
XEWO NW10 HS 7/8	S	PN 400	14	7/8" UNF	M 22 x 1.5	16	25	34	33	27	24	19.18 x 2.46
XEWO NW13 HS 7/8	S	PN 400	16	7/8" UNF	M 24 x 1.5	16	25	34	33	27	27	19.18 x 2.46
XEWO NW16 HS 1 1/16	S	PN 400	20	1.1/16" UN	M 30 x 2	19	28	37	38	30	32	23.47 x 2.95
XEWO NW20 HS 1 1/16	S	PN 400	25	1.1/16" UN	M 36 x 2	19	30	50	42	36	32	23.47 x 2.95
XEWO NW20 HS 1 5/16	S	PN 400	25	1.5/16" UN	M 36 x 2	19	33	50	45	41	36	29.74 x 2.95
XEWO NW25 HS 1 5/8	S	PN 250	30	1.5/8" UN	M 42 x 2	19	36	50	49	50	50	37.47 x 3.00
XEWO NW32 HS 1 7/8	S	PN 250	38	1.7/8" UN	M 52 x 2	19	34	51	50	50	55	43.69 x 3.00

系列: LL=特轻系列 L=轻系列 S=重系列; G1=接口螺纹 G2=接口螺纹

可调向端三通管接头 (L型)

结构形式: L形
 连接1: BSP标准外螺纹
 密封形式: G型
 连接2: 公制外螺纹
 密封形式: 24°内锥面密封
 连接3: 公制外螺纹
 密封形式: 24°内锥面密封

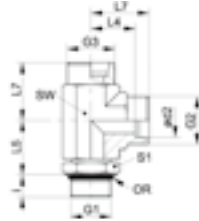

XELOR

订货号	系列	工作压力 bar	Ød2 mm	G1	管外径Ø mm	G2 - G3	i mm	L4 mm	L5 mm	L7 mm	SW mm	S1	OR
XELOR NW 06 HL	L	PN 315	8	G 1/4" -19	8	M 14 x 1.5	9.5	16	22.5	23	14	19	10.77 x 2.62
XELOR NW 08 HL	L	PN 315	10	G 1/4" -19	10	M 16 x 1.5	9.5	17	24.5	24	14	19	10.77 x 2.62
XELOR NW 10 HL	L	PN 250	12	G 3/8" -19	12	M 18 x 1.5	9.5	19	27.5	26	19	22	13.94 x 2.62
XELOR NW 13 HL	L	PN 250	15	G 1/2" -14	15	M 22 x 1.5	13.0	21	30.0	28	19	27	17.86 x 2.62
XELOR NW 16 HL	L	PN 250	18	G 1/2" -14	18	M 26 x 1.5	13.0	24	36.5	31	22	27	17.86 x 2.62
XELOR NW 20 HL	L	PN 160	22	G 3/4" -14	22	M 30 x 2	13.0	28	37.5	35	27	36	23.47 x 2.62
XELOR NW 25 HL	L	PN 160	28	G 1" -11	28	M 36 x 2	16.0	31	41.0	38	30	41	29.74 x 3.53
XELOR NW 32 HL	L	PN 160	35	G 1.1/4" -11	35	M 45 x 2	16.0	38	49.0	48	36	50	37.69 x 3.53
XELOR NW 40 HL	L	PN 160	42	G 1.1/2" -11	42	M 52 x 2	16.0	38	51.0	49	50	55	44.04 x 3.53
XELOR NW 32 HS	S	PN 160	38	G 1.1/2" -11	38	M 52 x 2	16.0	34	53.0	50	50	55	44.04 x 3.53

系列: LL=特轻系列 L=轻系列 S=重系列; G2-G3=接口螺纹 G1=接口螺纹

可调向端三通管接头 (L型)

结构形式: L形

连接1: BSP标准外螺纹

密封形式: O形圈和支撑环 (H型密封)

连接2: 公制外螺纹

密封形式: 24°内锥面密封

连接3: 公制外螺纹

密封形式: 24°内锥面密封

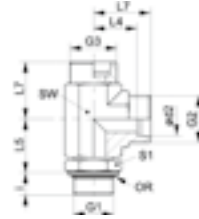

XELORK



订货号	系列	工作压力 bar	Ød2 mm	G1	管外径Ø mm	G2 - G3	i mm	L4 mm	L5 mm	L7 mm	SW mm	S1	S2	OR
XELORK NW 04 HL	L	PN 315	6	G 1/8" -28	6	M 12 x 1.5	7	14	19	21	14	14	14	8.00 x 1.50
XELORK NW 06 HL	L	PN 315	8	G 1/4" -19	8	M 14 x 1.5	9	16	23	23	14	19	17	10.77 x 2.62
XELORK NW 08 HL	L	PN 315	10	G 1/4" -19	10	M 16 x 1.5	9	17	25	24	19	19	19	10.77 x 2.62
XELORK NW 10 HL	L	PN 250	12	G 3/8" -19	12	M 18 x 1.5	9	19	28	26	19	22	22	13.94 x 2.62
XELORK NW 13 HL	L	PN 250	15	G 1/2" -14	15	M 22 x 1.5	13	21	30	28	22	27	27	17.86 x 2.62
XELORK NW 16 HL	L	PN 250	18	G 1/2" -14	18	M 26 x 1.5	13	24	36	31	27	27	32	17.86 x 2.62
XELORK NW 20 HL	L	PN 160	22	G 3/4" -14	22	M 30 x 2	13	28	36	35	30	36	36	23.47 x 2.62
XELORK NW 25 HL	L	PN 160	28	G 1" -11	28	M 36 x 2	15	31	44	38	36	41	41	29.74 x 3.53
XELORK NW 32 HL	L	PN 160	35	G 1.1/4" -11	35	M 45 x 2	15	38	50	48	50	50	50	37.69 x 3.53
XELORK NW 40 HL	L	PN 160	42	G 1.1/2" -11	42	M 52 x 2	15	38	52	49	50	55	60	44.04 x 3.53
XELORK NW 03 HS	S	PN 315	6	G 1/4" -19	6	M 14 x 1.5	9	15	23	22	14	19	17	10.77 x 2.62
XELORK NW 04 HS	S	PN 315	8	G 1/4" -19	8	M 16 x 1.5	9	17	27	24	19	19	19	10.77 x 2.62
XELORK NW 06 HS	S	PN 250	10	G 3/8" -19	10	M 18 x 1.5	9	18	29	25	19	22	22	13.94 x 2.62
XELORK NW 08 HS	S	PN 250	12	G 3/8" -19	12	M 18 x 1.5	9	22	29	29	22	22	24	13.94 x 2.62
XELORK NW 10 HS	S	PN 250	14	G 1/2" -14	14	M 22 x 1.5	13	25	36	33	27	27	27	17.86 x 2.62
XELORK NW 13 HS	S	PN 250	16	G 1/2" -14	16	M 24 x 1.5	13	25	36	33	27	27	30	17.86 x 2.62
XELORK NW 16 HS	S	PN 250	20	G 3/4" -14	20	M 30 x 2	12	28	39	38	30	36	36	23.47 x 2.62
XELORK NW 20 HS	S	PN 250	25	G 1" -11	25	M 36 x 2	14	30	44	42	36	41	46	29.74 x 3.53
XELORK NW 25 HS	S	PN 160	30	G 1.1/4" -11	30	M 42 x 2	15	36	49	51	50	50	50	37.69 x 3.53
XELORK NW 32 HS	S	PN 160	38	G 1.1/2" -11	38	M 52 x 2	15	34	55	50	50	55	60	44.04 x 3.53

系列: LL=特轻系列 L=轻系列 S=重系列; G2-G3=接口螺纹 G1=接口螺纹

可调向端三通管接头 (L型)

结构形式: L形

连接1: 公制圆柱管螺纹

密封形式: F型

连接2: 公制外螺纹

密封形式: 24°内锥面密封

连接3: 公制外螺纹

密封形式: 24°内锥面密封

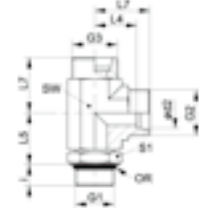

XELOM



订货号	系列	工作压力 bar	Ød2 mm	G1	管外径Ø mm	G2 - G3	i mm	L4 mm	L5 mm	L7 mm	SW mm	S1	OR
XELOM NW 04 HL	L	PN 315	6	M 10 x 1	6	M 12 x 1.5	7	14	20	21	14	14	8.1 x 1.6
XELOM NW 06 HL	L	PN 315	8	M 12 x 1.5	8	M 14 x 1.5	10	16	22	23	14	17	9.3 x 2.4
XELOM NW 08 HL	L	PN 315	10	M 14 x 1.5	10	M 16 x 1.5	10	17	25	24	19	19	11.3 x 2.4
XELOM NW 10 HL	L	PN 315	12	M 16 x 1.5	12	M 18 x 1.5	10	19	26	26	19	22	13.3 x 2.4
XELOM NW 13 HL	L	PN 315	15	M 18 x 1.5	15	M 22 x 1.5	11	21	30	28	22	24	15.3 x 2.4
XELOM NW 16 HL	L	PN 315	18	M 22 x 1.5	18	M 26 x 1.5	12	24	33	31	27	27	19.3 x 2.4
XELOM NW 20 HL 27	L	PN 160	22	M 27 x 2	22	M 30 x 2	14	28	35	35	30	32	23.6 x 2.9
XELOM NW 25 HL	L	PN 160	28	M 33 x 2	28	M 36 x 2	14	31	38	38	36	41	29.5 x 3.0
XELOM NW 32 HL	L	PN 160	35	M 42 x 2	35	M 45 x 2	14	38	48	48	50	50	38.0 x 3.0
XELOM NW 40 HL	L	PN 160	42	M 48 x 2	42	M 52 x 2	16	38	49	49	50	55	44.5 x 3.0
XELOM NW 03 HS	S	PN 400	6	M 12 x 1.5	6	M 14 x 1.5	10	15	22	22	14	17	9.3 x 2.4
XELOM NW 04 HS	S	PN 400	8	M 14 x 1.5	8	M 16 x 1.5	10	17	26	24	19	19	11.3 x 2.4
XELOM NW 06 HS	S	PN 400	10	M 16 x 1.5	10	M 18 x 1.5	11	18	27	25	19	22	13.3 x 2.4
XELOM NW 08 HS	S	PN 400	12	M 18 x 1.5	12	M 20 x 1.5	12	22	31	29	22	24	15.3 x 2.4
XELOM NW 10 HS	S	PN 250	14	M 20 x 1.5	14	M 22 x 1.5	14	22	34	30	24	27	17.3 x 2.4
XELOM NW 13 HS	S	PN 400	16	M 22 x 1.5	16	M 24 x 1.5	14	25	35	33	27	27	19.3 x 2.4
XELOM NW 16 HS	S	PN 400	20	M 27 x 2	20	M 30 x 2	16	28	35	38	30	32	23.6 x 2.9
XELOM NW 20 HS	S	PN 315	25	M 33 x 2	25	M 36 x 2	16	30	44	42	36	41	29.5 x 3.0
XELOM NW 25 HS	S	PN 250	30	M 42 x 2	30	M 42 x 2	17	36	51	49	50	50	38.0 x 3.0
XELOM NW 32 HS	S	PN 200	38	M 48 x 2	38	M 52 x 2	19	34	54	50	50	55	44.5 x 3.0

系列: LL=特轻系列 L=轻系列 S=重系列; G2-G3=接口螺纹 G1=接口螺纹

可调向端三通管接头 (L型)

XELOMK

结构形式: L形

连接1: 公制外螺纹

密封形式: O形圈和支撑环 (H型密封)

连接2: 公制外螺纹

密封形式: 24°内锥面密封

连接3: 公制外螺纹

密封形式: 24°内锥面密封

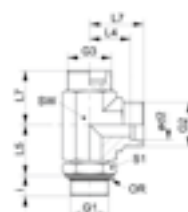

订货号	系列	工作压力 bar	Ød2 mm	G1	管外径Ø mm	G2 - G3	i mm	L4 mm	L5 mm	L7 mm	SW mm	S1	OR
XELOMK NW 04 HL	L	PN 315	6	M 10 x 1	6	M 12 x 1.5	7	14	20	21	14	13	8.1 x 1.6
XELOMK NW 06 HL	L	PN 315	8	M 12 x 1.5	8	M 14 x 1.5	10	16	22	23	14	17	9.3 x 2.4
XELOMK NW 08 HL	L	PN 315	10	M 14 x 1.5	10	M 16 x 1.5	9	17	25	24	19	17	11.3 x 2.4
XELOMK NW 10 HL	L	PN 315	12	M 16 x 1.5	12	M 18 x 1.5	9	19	26	26	19	19	13.3 x 2.4
XELOMK NW 13 HL	L	PN 315	15	M 18 x 1.5	15	M 22 x 1.5	11	21	30	28	22	22	15.3 x 2.4
XELOMK NW 16 HL	L	PN 250	18	M 22 x 1.5	18	M 26 x 1.5	11	24	33	31	27	27	19.3 x 2.4
XELOMK NW 20 HL	L	PN 160	22	M 26 x 1.5	22	M 30 x 2	16	28	35	35	30	32	23.3 x 2.4
XELOMK NW 20 HL 27	L	PN 160	22	M 27 x 2	22	M 30 x 2	14	28	35	35	30	36	23.6 x 2.9
XELOMK NW 25 HL	L	PN 160	28	M 33 x 2	28	M 36 x 2	14	31	38	38	36	38	29.5 x 3.0
XELOMK NW 32 HL	L	PN 160	35	M 42 x 2	35	M 45 x 2	14	38	48	48	50	50	38.0 x 3.0
XELOMK NW 40 HL	L	PN 160	42	M 48 x 2	42	M 52 x 2	16	49	49	49	50	55	44.5 x 3.0
XELOMK NW 03 HS	S	PN 315	6	M 12 x 1.5	6	M 14 x 1.5	10	15	22	22	14	17	9.3 x 2.4
XELOMK NW 04 HS	S	PN 315	8	M 14 x 1.5	8	M 16 x 1.5	10	17	26	24	19	17	11.3 x 2.4
XELOMK NW 06 HS	S	PN 315	10	M 16 x 1.5	10	M 18 x 1.5	11	18	27	25	19	19	13.3 x 2.4
XELOMK NW 08 HS	S	PN 315	12	M 18 x 1.5	12	M 20 x 1.5	12	22	31	29	22	22	15.3 x 2.4
XELOMK NW 10 HS	S	PN 315	14	M 20 x 1.5	14	M 22 x 1.5	14	25	35	33	27	27	17.3 x 2.4
XELOMK NW 13 HS	S	PN 250	16	M 22 x 1.5	16	M 24 x 1.5	14	25	35	33	27	27	19.3 x 2.4
XELOMK NW 16 HS	S	PN 250	20	M 27 x 2	20	M 30 x 2	16	28	39	38	30	32	23.6 x 2.9
XELOMK NW 20 HS	S	PN 160	25	M 33 x 2	25	M 36 x 2	16	30	44	42	36	38	29.5 x 3.0
XELOMK NW 25 HS	S	PN 160	30	M 42 x 2	30	M 42 x 2	17	36	51	49	50	50	38.0 x 2.0
XELOMK NW 32 HS	S	PN 160	38	M 48 x 2	38	M 52 x 2	19	34	54	50	50	55	44.5 x 3.0

系列: LL=特轻系列 L=轻系列 S=重系列; G2-G3=接口螺纹 G1=接口螺纹

可调向端三通管接头 (L型)

XELO

结构形式: L形

连接1: UN/UNF外螺纹

密封形式: O形圈密封

连接2: 公制外螺纹

密封形式: 24°内锥面密封

连接3: 公制外螺纹

密封形式: 24°内锥面密封

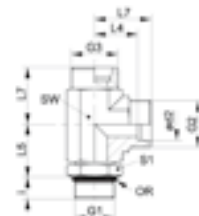

订货号	系列	工作压力 bar	Ød2 mm	G1	管外径Ø mm	G2 - G3	i mm	L4 mm	L5 mm	L7 mm	SW mm	S1	OR
XELO NW 04 HL 7/16	L	PN 315	6	7/16" -20 UNF	6	M 12 x 1.5	10	14	19	21	14	14	8.92 x 1.83
XELO NW 06 HL 7/16	L	PN 315	8	7/16" -20 UNF	8	M 14 x 1.5	10	16	19	23	14	14	8.92 x 1.83
XELO NW 06 HL 1/2	L	PN 315	8	1/2" -20 UNF	8	M 14 x 1.5	10	16	19	23	14	19	10.52 x 1.83
XELO NW 06 HL 9/16	L	PN 315	8	9/16" -18 UNF	8	M 14 x 1.5	10	16	19	23	19	17	11.90 x 1.98
XELO NW 08 HL 9/16	L	PN 315	10	9/16" -18 UNF	10	M 16 x 1.5	10	17	24	24	19	17	11.90 x 1.98
XELO NW 10 HL 9/16	L	PN 315	12	9/16" -18 UNF	12	M 18 x 1.5	11	19	25	26	19	17	11.90 x 1.98
XELO NW 10 HL 3/4	L	PN 315	12	3/4" -16 UNF	12	M 18 x 1.5	13	19	25	26	19	22	16.36 x 2.20
XELO NW 13 HL 3/4	L	PN 315	15	3/4" -16 UNF	15	M 22 x 1.5	13	21	28	28	22	22	16.36 x 2.20
XELO NW 13 HL 7/8	L	PN 315	15	7/8" -14 UNF	15	M 22 x 1.5	15	21	28	28	22	27	19.18 x 2.46
XELO NW 16 HL 7/8	L	PN 315	18	7/8" -14 UNF	18	M 26 x 1.5	15	24	32	31	27	27	19.18 x 2.46
XELO NW 16 HL 1 1/16	L	PN 315	18	1.1/16" -12 UN	18	M 26 x 1.5	17	24	32	31	30	32	23.47 x 2.95
XELO NW 20 HL 1 1/16	L	PN 160	22	1.1/16" -12 UN	22	M 30 x 2	17	28	35	35	30	32	23.47 x 2.95
XELO NW 25 HL 1 5/16	L	PN 160	28	1.5/16" -12 UN	28	M 36 x 2	17	31	42	38	36	41	29.74 x 2.95
XELO NW 32 HL 1 5/8	L	PN 160	35	1.5/8" -12 UN	35	M 45 x 2	17	38	46	48	50	50	37.47 x 3.00
XELO NW 40 HL 1 7/8	L	PN 160	42	1.7/8" -12 UN	42	M 52 x 2	17	38	47	49	50	55	43.69 x 3.00
XELO NW 03 HS 7/16	S	PN 400	6	7/16" -20 UNF	6	M 14 x 1.5	12	15	20	22	14	14	8.92 x 1.83
XELO NW 04 HS 1/2	S	PN 400	8	1/2" -20 UNF	8	M 16 x 1.5	12	15	20	22	14	17	10.52 x 1.83
XELO NW 04 HS 9/16	S	PN 400	8	9/16" -18 UNF	8	M 16 x 1.5	12	17	25	24	19	17	11.90 x 1.98
XELO NW 06 HS 9/16	S	PN 400	10	9/16" -18 UNF	10	M 18 x 1.5	12	18	26	25	19	17	11.90 x 1.98
XELO NW 08 HS 3/4	S	PN 400	12	3/4" -16 UNF	12	M 20 x 1.5	14	22	30	29	22	22	16.36 x 2.20
XELO NW 10 HS 7/8	S	PN 250	14	7/8" -14 UNF	14	M 22 x 1.5	16	25	34	33	27	27	19.18 x 2.46
XELO NW 13 HS 7/8	S	PN 400	16	7/8" -14 UNF	16	M 24 x 1.5	16	25	34	33	27	27	19.18 x 2.46
XELO NW 16 HS 1 1/16	S	PN 400	20	1.1/16" -12 UN	20	M 30 x 2	19	28	37	38	30	32	23.47 x 2.95
XELO NW 20 HS 1 1/16	S	PN 400	25	1.1/16" -12 UN	25	M 36 x 2	19	30	50	42	36	32	23.47 x 2.95
XELO NW 20 HS 1 5/16	S	PN 400	25	1.5/16" -12 UN	25	M 36 x 2	19	33	53	46	38	33	29.74 x 2.95
XELO NW 25 HS 1 5/8	S	PN 250	30	1.5/8" -12 UN	30	M 42 x 2	19	36	50	49	50	50	37.47 x 3.00
XELO NW 32 HS 1 7/8	S	PN 250	38	1.7/8" -12 UN	38	M 52 x 2	19	34	51	50	50	55	43.69 x 3.00

系列: LL=特轻系列 L=轻系列 S=重系列; G2-G3=接口螺纹 G1=接口螺纹

可调向端三通管接头 (T型)

结构形式: T形
 连接1: BSP标准外螺纹
 密封形式: G型
 连接2: 公制外螺纹
 密封形式: 24°内锥面密封
 连接3: 公制外螺纹
 密封形式: 24°内锥面密封

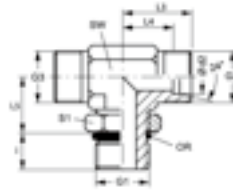

订货号	系列	工作压力 bar	Ød2 mm	G1	管外径 mm	G2 - G3	i mm	L3 mm	L4 mm	L5 mm	SW mm	S1	OR
XETOR NW 04 HL	L	PN 315	6	G 1/8" -28	6	M 12 x 1.5	7	21	14	19	14	14	8.00 x 1.50
XETOR NW 06 HL	L	PN 315	8	G 1/4" -19	8	M 14 x 1.5	9	23	16	23	14	19	10.77 x 2.62
XETOR NW 08 HL	L	PN 315	10	G 1/4" -19	10	M 16 x 1.5	9	24	17	25	19	19	10.77 x 2.62
XETOR NW 10 HL	L	PN 250	12	G 3/8" -19	12	M 18 x 1.5	9	26	19	28	19	22	13.94 x 2.62
XETOR NW 13 HL	L	PN 250	15	G 1/2" -14	15	M 22 x 1.5	13	28	21	30	22	27	17.86 x 2.62
XETOR NW 16 HL	L	PN 250	18	G 1/2" -14	18	M 26 x 1.5	13	31	24	36	27	27	17.86 x 2.62
XETOR NW 20 HL	L	PN 160	22	G 3/4" -14	22	M 30 x 2	13	35	28	36	30	36	23.47 x 2.62
XETOR NW 25 HL	L	PN 160	28	G 1" -11	28	M 36 x 2	15	38	31	44	36	41	29.5 x 3.53
XETOR NW 32 HL	L	PN 160	35	G 1.1/4" -11	35	M 45 x 2	15	48	38	50	50	50	37.69 x 3.53
XETOR NW 40 HL	L	PN 160	42	G 1.1/2" -11	42	M 52 x 2	15	49	38	52	50	50	44.04 x 3.53
XETOR NW 03 HS	S	PN 315	6	G 1/4" -19	6	M 14 x 1.5	9	22	15	23	14	19	10.77 x 2.62
XETOR NW 04 HS	S	PN 315	8	G 1/4" -19	8	M 16 x 1.5	9	24	17	27	19	19	10.77 x 2.62
XETOR NW 06 HS	S	PN 250	10	G 3/8" -14	10	M 18 x 1.5	9	25	18	29	19	22	13.94 x 2.62
XETOR NW 08 HS	S	PN 250	12	G 3/8" -14	12	M 20 x 1.5	9	29	22	29	22	22	13.94 x 2.62
XETOR NW 10 HS	S	PN 250	14	G 1/2" -14	14	M 22 x 1.5	13	43	25	36	27	27	17.86 x 2.62
XETOR NW 13 HS	S	PN 250	16	G 1/2" -14	16	M 24 x 1.5	13	33	25	36	27	27	17.86 x 2.62
XETOR NW 16 HS	S	PN 250	20	G 3/4" -14	20	M 30 x 2	12	38	28	39	30	36	23.47 x 2.62
XETOR NW 20 HS	S	PN 250	25	G 1" -11	25	M 36 x 2	14	42	30	44	36	41	29.74 x 3.53
XETOR NW 25 HS	S	PN 160	30	G 1.1/4" -11	30	M 42 x 2	15	49	36	49	50	50	37.69 x 3.53
XETOR NW 32 HS	S	PN 160	38	G 1.1/2" -11	38	M 52 x 2	15	50	34	55	50	55	44.04 x 3.53

系列: LL=特轻系列 L=轻系列 S=重系列; G2-G3=接口螺纹 G1=接口螺纹

可调向端三通管接头 (T型)

结构形式: T形
 连接1: BSP标准外螺纹
 密封形式: O形圈和支撑环 (H型密封)
 连接2: 公制外螺纹
 密封形式: 24°内锥面密封
 连接3: 公制外螺纹
 密封形式: 24°内锥面密封

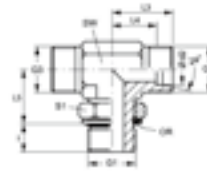

订货号	系列	工作压力 bar	Ød2 mm	G1	管外径 mm	G2 - G3	i mm	L3 mm	L4 mm	L5 mm	SW mm	S1	OR
XETORK NW 04 HL	L	PN 315	6	G 1/8" -19	6	M 12 x 1.5	7	21	14	19	14	14	8.00 x 1.50
XETORK NW 06 HL	L	PN 315	8	G 1/4" -19	8	M 14 x 1.5	9	23	16	23	14	19	10.77 x 2.62
XETORK NW 08 HL	L	PN 315	10	G 1/4" -19	10	M 16 x 1.5	9	24	17	25	19	19	10.77 x 2.62
XETORK NW 10 HL	L	PN 250	12	G 3/8" -19	12	M 18 x 1.5	9	26	19	28	19	22	13.94 x 2.62
XETORK NW 13 HL	L	PN 250	15	G 1/2" -14	15	M 22 x 1.5	13	28	21	30	22	27	17.86 x 2.62
XETORK NW 16 HL	L	PN 250	18	G 1/2" -14	18	M 26 x 1.5	13	31	24	36	27	27	17.86 x 2.62
XETORK NW 20 HL	L	PN 160	22	G 3/4" -14	22	M 30 x 2	13	35	28	36	30	36	23.47 x 2.62
XETORK NW 25 HL	L	PN 160	28	G 1" -11	28	M 36 x 2	15	38	31	44	36	41	29.50 x 3.53
XETORK NW 32 HL	L	PN 160	35	G 1.1/4" -11	35	M 45 x 2	15	48	38	50	50	50	37.69 x 3.53
XETORK NW 40 HL	L	PN 160	42	G 1.1/2" -11	42	M 52 x 2	15	49	38	52	50	50	44.04 x 3.53
XETORK NW 03 HS	S	PN 315	6	G 1/4" -19	6	M 14 x 1.5	9	22	15	23	14	19	10.77 x 2.62
XETORK NW 04 HS	S	PN 315	8	G 1/4" -19	8	M 16 x 1.5	9	24	17	27	19	19	10.77 x 2.62
XETORK NW 06 HS	S	PN 250	10	G 3/8" -19	10	M 18 x 1.5	9	25	18	29	19	22	13.94 x 2.62
XETORK NW 08 HS	S	PN 250	12	G 3/8" -19	12	M 20 x 1.5	9	29	22	29	22	22	13.94 x 2.62
XETORK NW 10 HS	S	PN 250	14	G 1/2" -14	14	M 22 x 1.5	13	33	25	36	27	27	17.86 x 2.62
XETORK NW 13 HS	S	PN 250	16	G 1/2" -14	16	M 24 x 1.5	13	33	25	36	27	27	17.86 x 2.62
XETORK NW 16 HS	S	PN 250	20	G 3/4" -14	20	M 30 x 2	12	38	28	39	30	36	23.47 x 2.62
XETORK NW 20 HS	S	PN 250	25	G 1" -11	25	M 36 x 2	14	42	30	44	36	41	29.74 x 3.53
XETORK NW 25 HS	S	PN 160	30	G 1.1/4" -11	30	M 42 x 2	15	49	36	49	50	50	37.69 x 3.53
XETORK NW 32 HS	S	PN 160	38	G 1.1/2" -11	38	M 52 x 2	15	50	34	55	50	55	44.04 x 3.53

系列: LL=特轻系列 L=轻系列 S=重系列; G2-G3=接口螺纹 G1=接口螺纹

可调向端三通管接头 (T型)

XETOM

结构形式: T形

连接1: 公制圆柱管螺纹

密封形式: F型

连接2: 公制外螺纹

密封形式: 24°内锥面密封

连接3: 公制外螺纹

密封形式: 24°内锥面密封

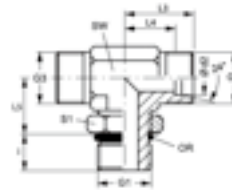

订货号	系列	工作压力 bar	Ød2 mm	G1	管外径Ø mm	G2 - G3	i mm	L3 mm	L4 mm	L5 mm	SW mm	S1	OR
XETOM NW 04 HL	L	PN 315	6	M 10 x 1	6	M 12 x 1.5	7	21	14	20	14	14	8.1 x 1.6
XETOM NW 06 HL	L	PN 315	8	M 12 x 1.5	8	M 14 x 1.5	10	23	16	22	14	17	9.3 x 2.4
XETOM NW 08 HL	L	PN 315	10	M 14 x 1.5	10	M 16 x 1.5	10	24	17	25	19	19	11.3 x 2.4
XETOM NW 10 HL	L	PN 315	12	M 16 x 1.5	12	M 18 x 1.5	10	26	19	26	19	22	13.3 x 2.4
XETOM NW 13 HL	L	PN 315	15	M 18 x 1.5	15	M 22 x 1.5	11	28	21	30	22	24	15.3 x 2.4
XETOM NW 16 HL	L	PN 315	18	M 22 x 1.5	18	M 26 x 1.5	12	31	24	33	27	27	19.3 x 2.4
XETOM NW 20 HL 27	L	PN 160	22	M 27 x 2	22	M 30 x 2	14	35	28	35	30	32	23.6 x 2.9
XETOM NW 25 HL	L	PN 160	28	M 33 x 2	28	M 36 x 2	14	38	31	38	36	41	29.5 x 3.0
XETOM NW 32 HL	L	PN 160	35	M 42 x 2	35	M 45 x 2	14	48	38	48	50	50	38.0 x 3.0
XETOM NW 40 HL	L	PN 160	42	M 48 x 2	42	M 52 x 2	16	49	38	49	50	55	44.5 x 3.0
XETOM NW 03 HS	S	PN 400	6	M 12 x 1.5	6	M 14 x 1.5	10	22	15	22	14	17	9.3 x 2.4
XETOM NW 04 HS	S	PN 400	8	M 14 x 1.5	8	M 16 x 1.5	10	24	17	26	19	19	11.3 x 2.4
XETOM NW 06 HS	S	PN 400	10	M 16 x 1.5	10	M 18 x 1.5	11	25	19	27	19	22	13.3 x 2.4
XETOM NW 08 HS	S	PN 400	12	M 18 x 1.5	12	M 20 x 1.5	12	29	22	31	22	24	15.3 x 2.4
XETOM NW 10 HS	S	PN 250	14	M 20 x 1.5	14	M 22 x 1.5	14	33	25	35	27	27	17.3 x 2.4
XETOM NW 13 HS	S	PN 400	16	M 22 x 1.5	16	M 24 x 1.5	14	33	25	35	27	27	19.3 x 2.4
XETOM NW 16 HS	S	PN 400	20	M 27 x 2	20	M 30 x 2	16	38	28	39	30	32	23.6 x 2.9
XETOM NW 20 HS	S	PN 315	25	M 33 x 2	25	M 36 x 2	16	42	30	44	36	41	29.5 x 3.0
XETOM NW 25 HS	S	PN 250	30	M 42 x 2	30	M 42 x 2	17	49	36	51	50	50	38.0 x 3.0
XETOM NW 32 HS	S	PN 200	38	M 48 x 2	38	M 52 x 2	19	50	34	54	50	55	44.5 x 3.0

系列: LL=特轻系列 L=轻系列 S=重系列; G2-G3=接口螺纹 G1=接口螺纹

可调向端三通管接头(T型)

XETOMK

结构形式: T形

连接1: 公制圆柱管螺纹

密封形式: O形圈和支撑环 (H型密封)

连接2: 公制外螺纹

密封形式: 24°内锥面密封

连接3: 公制外螺纹

密封形式: 24°内锥面密封

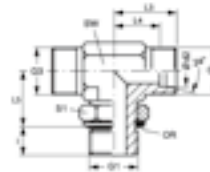

订货号	系列	工作压力 bar	Ød2 mm	G1	管外径Ø mm	G2 - G3	i mm	L3 mm	L4 mm	L5 mm	SW mm	S1	OR
XETOMK NW 04 HL	L	PN 315	6	M 10 x 1	6	M 12 x 1.5	7	21	14	20	14	13	8.1 x 6.0
XETOMK NW 06 HL	L	PN 315	8	M 12 x 1.5	8	M 14 x 1.5	10	23	16	22	14	17	9.3 x 2.4
XETOMK NW 08 HL	L	PN 315	10	M 14 x 1.5	10	M 16 x 1.5	9	24	17	25	19	17	11.3 x 2.4
XETOMK NW 10 HL	L	PN 315	12	M 16 x 1.5	12	M 18 x 1.5	9	26	19	26	19	19	13.3 x 2.4
XETOMK NW 13 HL	L	PN 315	15	M 18 x 1.5	15	M 22 x 1.5	11	28	21	30	22	22	15.3 x 2.4
XETOMK NW 16 HL	L	PN 250	18	M 22 x 1.5	18	M 36 x 1.5	11	31	24	33	27	27	19.3 x 2.4
XETOMK NW 20 HL	L	PN 160	22	M 26 x 1.5	22	M 30 x 2	16	35	28	35	30	36	23.3 x 2.4
XETOMK NW 20 HL 27	L	PN 160	22	M 27 x 2	22	M 30 x 2	14	35	28	35	30	32	23.6 x 2.9
XETOMK NW 25 HL	L	PN 160	28	M 33 x 2	28	M 36 x 2	14	38	31	38	36	38	29.5 x 3.0
XETOMK NW 32 HL	L	PN 160	35	M 42 x 2	35	M 45 x 2	14	48	38	48	50	50	38.0 x 3.0
XETOMK NW 40 HL	L	PN 160	42	M 48 x 2	42	M 52 x 2	16	49	38	49	50	55	44.5 x 3.0
XETOMK NW 03 HS	S	PN 315	6	M 12 x 1.5	6	M 14 x 1.5	10	22	15	22	14	17	9.3 x 2.4
XETOMK NW 04 HS	S	PN 315	8	M 14 x 1.5	8	M 16 x 1.5	10	20	17	26	19	17	11.3 x 2.4
XETOMK NW 06 HS	S	PN 315	10	M 16 x 1.5	10	M 18 x 1.5	11	25	18	27	19	19	13.3 x 2.4
XETOMK NW 08 HS	S	PN 315	12	M 18 x 1.5	12	M 20 x 1.5	12	29	22	31	22	22	15.3 x 2.4
XETOMK NW 10 HS	S	PN 315	14	M 20 x 1.5	14	M 22 x 1.5	14	33	25	35	27	27	17.3 x 2.4
XETOMK NW 13 HS	S	PN 250	16	M 22 x 1.5	16	M 24 x 1.5	14	33	25	35	27	27	19.3 x 2.4
XETOMK NW 16 HS	S	PN 250	20	M 27 x 2	20	M 30 x 2	16	38	28	39	30	32	23.6 x 2.9
XETOMK NW 20 HS	S	PN 160	25	M 33 x 2	25	M 36 x 2	16	42	30	44	36	38	29.5 x 3.0
XETOMK NW 25 HS	S	PN 160	30	M 42 x 2	30	M 42 x 2	17	49	36	51	50	50	38.0 x 3.0
XETOMK NW 32 HS	S	PN 160	38	M 48 x 2	38	M 52 x 2	19	50	34	54	50	55	44.5 x 3.0

系列: LL=特轻系列 L=轻系列 S=重系列; G2-G3=接口螺纹 G1=接口螺纹

可调向端三通管接头(T型)

XETO

结构形式: T形

连接1: UN/UNF外螺纹

密封形式: O形圈密封

连接2: 公制外螺纹

密封形式: 24°内锥面密封

连接3: 公制外螺纹

密封形式: 24°内锥面密封

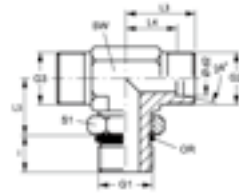

订货号	系列	工作压力 bar	Ød2 mm	G1	管外径Ø mm	G2 - G3	i mm	L3 mm	L4 mm	L5 mm	SW mm	S1	OR
XETO NW 04 HL 7/16	L	PN 315	6	UNF 7/16" -20	6	M 12 x 1.5	10	29	14	19	14	14	8.92 x 1.83
XETO NW 06 HL 7/16	L	PN 315	8	UNF 7/16" -20	8	M 14 x 1.5	10	31	16	19	14	14	8.92 x 1.83
XETO NW 06 HL 1/2	L	PN 315	8	UNF 1/2" -20	8	M 14 x 1.5	10	31	16	19	14	17	10.52 x 1.83
XETO NW 06 HL 9/16	L	PN 315	8	UNF 9/16" -18	8	M 14 x 1.5	10	31	16	24	17	19	11.90 x 1.98
XETO NW 08 HL 9/16	L	PN 315	10	UNF 9/16" -18	10	M 16 x 1.5	10	32	17	24	17	19	11.90 x 1.98
XETO NW 10 HL 3/4	L	PN 315	12	UNF 3/4" -16	12	M 18 x 1.5	13	34	19	25	22	19	16.36 x 2.20
XETO NW 10 HL 9/16	L	PN 315	12	UNF 9/16" -18	12	M 18 x 1.5	11	34	19	25	17	19	11.90 x 1.98
XETO NW 13 HL 3/4	L	PN 315	15	UNF 3/4" -16	15	M 22 x 1.5	13	36	21	28	22	22	16.36 x 2.20
XETO NW 13 HL 7/8	L	PN 315	15	UNF 7/8" -14	15	M 22 x 1.5	15	36	21	28	27	22	19.18 x 2.46
XETO NW 16 HL 1 1/16	L	PN 315	18	UN 1.1/16" -12	18	M 26 x 1.5	17	40	24	32	32	30	23.47 x 2.95
XETO NW 16 HL 7/8	L	PN 315	18	UNF 7/8" -14	18	M 26 x 1.5	15	40	24	32	27	27	19.18 x 2.46
XETO NW 20 HL 1 1/16	L	PN 160	22	UN 1.1/16" -12	22	M 30 x 2	17	44	28	35	32	30	23.47 x 2.95
XETO NW 25 HL 1 5/16	L	PN 160	28	UN 1.5/16" -12	28	M 36 x 2	17	47	31	42	41	36	29.74 x 2.95
XETO NW 32 HL 1 5/8	L	PN 160	35	UN 1.5/8" -12	35	M 45 x 2	17	59	38	46	50	50	37.47 x 3.00
XETO NW 40 HL 1 7/8	L	PN 160	42	UN 1.7/8" -12	42	M 52 x 2	17	61	38	47	55	50	43.69 x 3.00
XETO NW 03 HS 7/16	S	PN 400	6	UNF 7/16" -20	6	M 14 x 1.5	12	30	15	20	14	14	8.92 x 1.83
XETO NW 04 HS 1/2	S	PN 400	8	UNF 1/2" -20	8	M 16 x 1.5	12	32	19	25	19	17	10.52 x 1.83
XETO NW 04 HS 9/16	S	PN 400	8	UNF 9/16" -18	8	M 16 x 1.5	12	32	17	25	19	17	11.90 x 1.98
XETO NW 06 HS 9/16	S	PN 400	10	UNF 9/16" -18	10	M 18 x 1.5	12	34	18	26	17	19	11.90 x 1.98
XETO NW 08 HS 3/4	S	PN 400	12	UNF 3/4" -16	12	M 20 x 1.5	14	38	22	30	22	22	16.36 x 2.20
XETO NW 10 HS 7/8	S	PN 250	14	UNF 7/8" -14	14	M 22 x 1.5	13	34	16	31	27	27	19.18 x 2.95
XETO NW 13 HS 7/8	S	PN 400	16	UNF 7/8" -14	16	M 24 x 1.5	16	43	25	34	27	27	19.18 x 2.46
XETO NW 16 HS 1 1/16	S	PN 400	20	UN 1.1/16" -12	20	M 30 x 2	19	49	28	37	32	30	23.47 x 2.95
XETO NW 20 HS 1 1/16	S	PN 400	25	UN 1.1/16" -12	25	M 36 x 2	19	54	30	50	32	36	23.47 x 2.95
XETO NW 20 HS 1 5/16	S	PN 250	25	UN 1.5/16" -12	25	M 36 x 2	19	54	30	50	36	41	29.74 x 2.95
XETO NW 25 HS 1 5/8	S	PN 250	30	UN 1.5/8" -12	30	M 42 x 2	19	62	36	50	50	50	37.47 x 3.00
XETO NW 32 HS 1 7/8	S	PN 250	38	UN 1.7/8" -12	38	M 52 x 2	19	65	34	51	55	50	43.69 x 3.00

系列: LL=特轻系列 L=轻系列 S=重系列; G2-G3=接口螺纹 G1=接口螺纹

旋入式隔板接头

XSVR-ED

连接1: BSP标准外螺纹

密封形式: E型

连接2: 公制外螺纹

密封形式: 24°内锥面密封

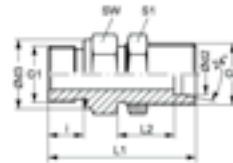

订货号	系列	工作压力 bar	Ød2 mm	G1	管外径Ø mm	G2	Ød3 mm	i mm	L1 mm	L2 mm	SW mm	S1
XSVR NW 06 HL ED	L	PN 315	8	G 1/4" -19	8	M 14 x 1.5	18.9	12	53.0	27.0	19	19
XSVR NW 06 HL 3/8 ED	L	PN 315	8	G 3/8" -19	8	M 14 x 1.5	21.9	12	54.5	27.0	22	19
XSVR NW 06 HL 1/2 ED	L	PN 315	8	G 1/2" -14	8	M 14 x 1.5	26.9	14	58.0	27.0	27	19
XSVR NW 08 HL ED	L	PN 315	10	G 1/4" -19	10	M 16 x 1.5	18.9	12	55.0	28.0	22	22
XSVR NW 08 HL 1/2 ED	L	PN 315	10	G 1/2" -14	10	M 16 x 1.5	26.9	14	59.0	27.0	27	22
XSVR NW 10 HL ED	L	PN 315	12	G 3/8" -19	12	M 18 x 1.5	21.9	12	56.5	29.0	24	24
XSVR NW 10 HL 1/2 ED	L	PN 315	12	G 1/2" -14	12	M 18 x 1.5	26.9	14	60.0	29.0	27	24
XSVR NW 13 HL ED	L	PN 250	15	G 1/2" -14	15	M 22 x 1.5	26.9	14	62.0	31.0	27	30
XSVR NW 13 HL 3/4 ED	L	PN 250	15	G 3/4" -14	15	M 22 x 1.5	31.9	16	66.0	31.0	32	30
XSVR NW 16 HL ED	L	PN 250	18	G 1/2" -14	18	M 26 x 1.5	26.9	14	66.0	33.5	32	36
XSVR NW 16 HL 3/4 ED	L	PN 250	18	G 3/4" -14	18	M 26 x 1.5	31.9	16	68.0	33.5	32	36
XSVR NW 16 HL 1 ED	L	PN 250	18	G 1" -11	18	M 26 x 1.5	39.9	18	73.0	33.5	41	36
XSVR NW 20 HL ED	L	PN 250	22	G 3/4" -14	22	M 30 x 2	31.9	16	71.0	34.5	36	41
XSVR NW 40 HL ED	L	PN 250	42	G 1.1/2" -11	42	M 52 x 2	54.9	22	86.0	36.0	60	65
XSVR NW 08 HS 1/2 ED	S	PN 400	12	G 1/2" -14	12	M 20 x 1.5	26.9	14	65.0	30.5	27	27
XSVR NW 13 HS ED	S	PN 400	16	G 1/2" -14	16	M 24 x 1.5	26.9	14	68.0	31.5	32	32
XSVR NW 13 HS 3/4 ED	S	PN 400	16	G 3/4" -14	16	M 24 x 1.5	31.9	16	70.0	31.5	32	32
XSVR NW 16 HS ED	S	PN 400	20	G 3/4" -14	20	M 30 x 2	31.9	16	75.0	33.5	41	41
XSVR NW 20 HS 3/4 ED	S	PN 250	25	G 3/4" -14	25	M 36 x 2	31.9	16	80.0	35.0	46	46
XSVR NW 20 HS ED	S	PN 250	25	G 1" -11	25	M 36 x 2	39.9	18	82.0	35.0	46	46
XSVR NW 25 HS ED	S	PN 160	30	G 1.1/4" -11	30	M 42 x 2	49.9	20	89.0	37.5	50	50

系列: LL=特轻系列 L=轻系列 S=重系列; G1=接口螺纹 G2=接口螺纹

旋入式隔板接头

连接1: 公制圆柱管螺纹
密封形式: B型
连接2: 公制外螺纹
密封形式: 24°内锥面密封

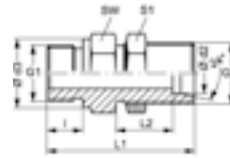

X SVM

订货号	系列	工作压力 bar	Ød2 mm	G1	管外径Ø mm	G2	Ød3 mm	i mm	L1 mm	SW mm	S1
X SVM NW 13 HS	S	PN 400	16	M 22 x 1.5	16	M 24 x 1.5	27	14	68.0	32	32
X SVM NW 16 HS 22	S	PN 400	20	M 22 x 1.5	20	M 30 x 2	27	14	70.0	41	41
X SVM NW 16 HS 26	S	PN 400	20	M 26 x 1.5	20	M 30 x 2	31	16	72.0	41	41
X SVM NW 20 HS 26	S	PN 400	25	M 26 x 1.5	25	M 36 x 2	31	16	75.0	41	46
X SVM NW 20 HS 30-1.5	S	PN 400	25	M 30 x 1.5	25	M 36 x 2	36	16	75.0	41	46
X SVM NW 25 HS 30-1.5	S	PN 400	30	M 30 x 1.5	30	M 42 x 2	36	16	79.0	50	50
X SVM NW 25 HS 38-1.5	S	PN 400	30	M 38 x 1.5	30	M 42 x 2	44	16	79.0	50	50
X SVM NW 25 HS 45-1.5	S	PN 400	30	M 45 x 1.5	30	M 42 x 2	52	16	79.0	55	50
X SVM NW 32 HS 38-1.5	S	PN 315	38	M 38 x 1.5	38	M 52 x 2	44	16	81.5	60	65
X SVM NW 32 HS 45-1.5	S	PN 315	38	M 45 x 1.5	38	M 52 x 2	52	16	81.5	60	65

系列: LL=特轻系列 L=轻系列 S=重系列; G1=接口螺纹 G2=接口螺纹

直通隔板接头

连接1: 公制外螺纹
密封形式: 24°内锥面密封
连接2: 公制外螺纹
密封形式: 24°内锥面密封

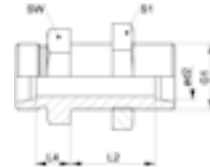

X SV

订货号	系列	工作压力 bar	Ød2 mm	G1	管外径Ø mm	L2 mm	L4 mm	SW mm	S1
X SV NW 04 HL	L	PN 315	6	M 12 x 1.5	6	27.0	7.0	17	17
X SV NW 06 HL	L	PN 315	8	M 14 x 1.5	8	27.0	8.0	19	19
X SV NW 08 HL	L	PN 315	10	M 16 x 1.5	10	28.0	10.0	22	22
X SV NW 10 HL	L	PN 315	12	M 18 x 1.5	12	29.0	10.0	24	24
X SV NW 13 HL	L	PN 315	15	M 22 x 1.5	15	31.0	12.0	27	30
X SV NW 16 HL	L	PN 315	18	M 26 x 1.5	18	32.5	13.5	32	36
X SV NW 20 HL	L	PN 160	22	M 30 x 2	22	34.5	16.5	36	41
X SV NW 25 HL	L	PN 160	28	M 36 x 2	28	35.5	18.5	41	46
X SV NW 32 HL	L	PN 160	35	M 45 x 2	35	36.5	18.5	50	55
X SV NW 40 HL	L	PN 160	42	M 52 x 2	42	36.0	19.0	60	65
X SV NW 03 HS	S	PN 630	6	M 14 x 1.5	6	29.0	12.0	19	19
X SV NW 04 HS	S	PN 630	8	M 16 x 1.5	8	29.0	13.0	22	22
X SV NW 06 HS	S	PN 630	10	M 18 x 1.5	10	29.5	14.5	24	24
X SV NW 08 HS	S	PN 630	12	M 20 x 1.5	12	30.5	14.5	27	27
X SV NW 10 HS	S	PN 630	14	M 22 x 1.5	14	32.0	17.0	30	30
X SV NW 13 HS	S	PN 400	16	M 24 x 1.5	16	31.5	16.5	32	32
X SV NW 16 HS	S	PN 400	20	M 30 x 2	20	33.5	17.5	41	41
X SV NW 20 HS	S	PN 400	25	M 36 x 2	25	35.0	20.0	46	46
X SV NW 25 HS	S	PN 400	30	M 42 x 2	30	37.5	21.5	50	50
X SV NW 32 HS	S	PN 315	38	M 52 x 2	38	37.0	22.0	65	65

系列: LL=特轻系列 L=轻系列 S=重系列; G1=接口螺纹

直角隔板接头

连接1: 公制外螺纹
密封形式: 24°内锥面密封
连接2: 公制外螺纹
密封形式: 24°内锥面密封

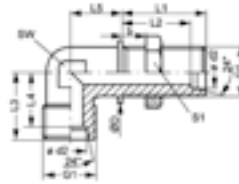

XSW

订货号	系列	工作压力 bar	Ød2 mm	管外径Ø mm	G1	ØD mm	b mm	L1 mm	L2 mm	L3 mm	L4 mm	L5 mm	SW mm	S1
XSW NW 04 HL	L	PN 315	6	6	M 12 x 1.5	17	16	34	27	19	12	14	12	17
XSW NW 06 HL	L	PN 315	8	8	M 14 x 1.5	19	16	34	27	21	14	17	12	19
XSW NW 08 HL	L	PN 315	10	10	M 16 x 1.5	22	16	35	28	22	15	18	14	22
XSW NW 10 HL	L	PN 315	12	12	M 18 x 1.5	24	16	36	29	24	17	20	17	24
XSW NW 13 HL	L	PN 315	15	15	M 22 x 1.5	27	16	38	31	28	21	23	19	30
XSW NW 16 HL	L	PN 315	18	18	M 26 x 1.5	32	16	40	32.5	31	23.5	24	24	36
XSW NW 20 HL	L	PN 160	22	22	M 30 x 2	36	16	42	34.5	35	27.5	30	27	41
XSW NW 25 HL	L	PN 160	28	28	M 36 x 2	42	16	43	35.5	38	30.5	34	36	46
XSW NW 32 HL	L	PN 160	35	35	M 45 x 2	50	16	47	36.5	45	34.5	39	41	55
XSW NW 40 HL	L	PN 160	42	42	M 52 x 2	60	16	47	36	51	40	43	50	65
XSW NW 03 HS	S	PN 630	6	6	M 14 x 1.5	19	16	36	29	23	16	17	12	19
XSW NW 04 HS	S	PN 630	8	8	M 16 x 1.5	22	16	36	29	24	17	18	14	22
XSW NW 06 HS	S	PN 630	10	10	M 18 x 1.5	24	16	36	29.5	25	17.5	20	17	24
XSW NW 08 HS	S	PN 630	12	12	M 20 x 1.5	27	16	38	30.5	29	21.5	21	17	27
XSW NW 10 HS	S	PN 630	14	14	M 22 x 1.5	27	16	40	32	30	22	23	19	30
XSW NW 13 HS	S	PN 400	16	16	M 24 x 1.5	30	16	40	31.5	33	24.5	24	24	32
XSW NW 16 HS	S	PN 400	20	20	M 30 x 2	36	16	44	33.5	37	26.5	30	27	41
XSW NW 20 HS	S	PN 400	25	25	M 36 x 2	42	16	47	35	42	30	34	36	46
XSW NW 25 HS	S	PN 400	30	30	M 42 x 2	50	16	51	37.5	49	35.5	39	41	50
XSW NW 32 HS	S	PN 315	38	38	M 52 x 2	60	16	53	37	57	41	43	50	65

系列: LL=特轻系列 L=轻系列 S=重系列; G1=接口螺纹

焊接接管(L系列)

连接1: 适用于公制钢管的焊接接管
密封形式: 24°锥带O形圈密封

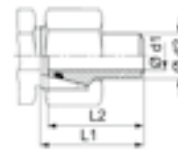

SA-DKOL



订货号	系列	工作压力 bar	Ød1 mm	Ød2 mm	L1 mm	L2 mm	OR
SA NW 04 DKOL 1	L	PN 315	4	6	32	30.5	4.0 x 1.5
SA NW 06 DKOL 1	L	PN 315	6	8	32	30.5	6.0 x 1.5
SA NW 08 DKOL 1	L	PN 249	8	10	33.5	32.5	7.5 x 1.5
SA NW 10 DKOL 1.5	L	PN 315	9	12	33.5	32.5	9.0 x 1.5
SA NW 13 DKOL 2.5	L	PN 315	10	15	35	34.5	12.0 x 2.0
SA NW 16 DKOL 2.5	L	PN 315	13	18	37	36.0	15.0 x 2.0
SA NW 20 DKOL 2.5	L	PN 160	17	22	39.5	37.5	20.0 x 2.0
SA NW 25 DKOL 2.5	L	PN 160	23	28	53	41.0	26.0 x 2.0
SA NW 25 DKOL 3	L	PN 160	22	28	42.5	41.0	26.0 x 2.0
SA NW 32 DKOL 3	L	PN 160	29	35	61	47.0	32.0 x 2.5
SA NW 32 DKOL 3.5	L	PN 160	28	35	49.5	47.0	32.0 x 2.5
SA NW 40 DKOL 2	L	PN 129	38	42	50	47.0	38.0 x 2.5
SA NW 40 DKOL 3	L	PN 160	36	42	50	47.0	38.0 x 2.5

系列: LL=特轻系列 L=轻系列 S=重系列

焊接接管(S系列)

连接1: 适用于公制钢管的焊接接管
密封形式: 24°锥带O形圈密封

SA-DKO

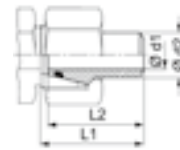

订货号	系列	压力 bar	Ød1 mm	管外径Ø mm	Ød2 mm	L1 mm	L2 mm	OR
SA NW 03 DKO 1.5	S	PN 528	3	6	6	32.5	31.0	4.0 x 1.5
SA NW 04 DKO 1.5	S	PN 414	5	6	6	32.0	30.0	6.0 x 1.5
SA NW 04 DKO 2	S	PN 528	4	8	8	31.5	31.0	6.0 x 1.5
SA NW 06 DKO 1	S	PN 249	8	10	10	33.5	32.5	7.5 x 1.5
SA NW 06 DKO 1.5	S	PN 358	7	10	10	33.5	31.5	7.5 x 1.5
SA NW 06 DKO 2	S	PN 460	6	10	10	33.5	31.5	7.5 x 1.5
SA NW 08 DKO 1.5	S	PN 305	9	12	12	33.5	31.5	9.0 x 1.5
SA NW 08 DKO 2	S	PN 393	8	12	12	33.5	31.5	9.0 x 1.5
SA NW 08 DKO 2.5	S	PN 476	7	12	12	33.5	31.5	9.0 x 1.5
SA NW 08 DKO 3	S	PN 551	6	12	12	33.5	32.5	9.0 x 1.5
SA NW 10 DKO 2	S	PN 343	10	14	14	40.0	37.5	10.0 x 2.0
SA NW 10 DKO 3	S	PN 487	8	14	14	39.5	38.5	10.0 x 2.0
SA NW 13 DKO 1.5	S	PN 234	13	16	16	40.5	37.5	12.0 x 2.0
SA NW 13 DKO 2	S	PN 305	12	16	16	40.5	37.5	12.0 x 2.0
SA NW 13 DKO 2.5	S	PN 372	11	16	16	40.5	37.5	12.0 x 2.0
SA NW 13 DKO 3	S	PN 400	10	16	16	40.5	37.5	12.0 x 2.0
SA NW 16 DKO 2	S	PN 249	16	20	20	47.0	43.5	16.3 x 2.4
SA NW 16 DKO 2.5	S	PN 305	15	20	20	46.5	43.0	16.3 x 2.4
SA NW 16 DKO 3	S	PN 358	14	20	20	46.5	43.0	16.3 x 2.4
SA NW 16 DKO 3.5	S	PN 400	13	20	20	47.5	43.5	16.3 x 2.4
SA NW 16 DKO 4	S	PN 400	12	20	20	46.5	43.0	16.3 x 2.4
SA NW 20 DKO 2	S	PN 201	21	25	25	53.0	48.0	20.3 x 2.4
SA NW 20 DKO 3	S	PN 294	19	25	25	53.0	48.0	20.3 x 2.4
SA NW 20 DKO 4	S	PN 379	17	25	25	53.0	48.0	20.3 x 2.4
SA NW 20 DKO 5	S	PN 400	15	25	25	53.0	48.0	20.3 x 2.4
SA NW 25 DKO 3	S	PN 249	24	30	30	57.5	51.5	25.3 x 2.4
SA NW 25 DKO 4	S	PN 323	22	30	30	57.5	51.5	25.3 x 2.4
SA NW 25 DKO 5	S	PN 393	20	30	30	57.5	51.5	25.3 x 2.4
SA NW 25 DKO 6	S	PN 400	18	30	30	57.0	52.0	25.3 x 2.4
SA NW 32 DKO 4	S	PN 261	30	38	38	64.0	55.0	33.3 x 2.4
SA NW 32 DKO 5	S	PN 315	28	38	38	64.0	55.0	33.3 x 2.4
SA NW 32 DKO 6	S	PN 315	26	38	38	64.0	55.0	33.3 x 2.4
SA NW 32 DKO 7	S	PN 315	24	38	38	64.0	56.5	33.3 x 2.4

系列: LL=特轻系列 L=轻系列 S=重系列

焊接式直通接头

连接1: 适用于公制钢管的焊接管

连接2: 公制外螺纹

密封形式: 24°内锥面密封

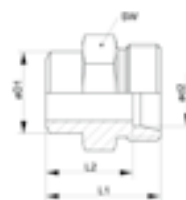

XSA

订货号	系列	工作压力 bar	Ød2 mm	管外径Ø mm	ØD1 mm	L1 mm	L2 mm	SW mm
XSA NW 04 HL	L	PN 315	6	6	10	21	14.0	14
XSA NW 06 HL	L	PN 315	8	8	12	23	16.0	14
XSA NW 08 HL	L	PN 315	10	10	14	25	18.0	17
XSA NW 10 HL	L	PN 315	12	12	16	25	18.0	19
XSA NW 13 HL	L	PN 315	15	15	19	29	22.0	22
XSA NW 16 HL	L	PN 315	18	18	22	31	23.5	27
XSA NW 20 HL	L	PN 160	22	22	27	36	28.5	32
XSA NW 25 HL	L	PN 160	28	28	32	38	30.5	41
XSA NW 32 HL	L	PN 160	35	35	40	43	32.5	46
XSA NW 40 HL	L	PN 160	42	42	46	46	35.0	55
XSA NW 03 HS	S	PN 630	6	6	11	26	19.0	14
XSA NW 04 HS	S	PN 630	8	8	13	28	21.0	17
XSA NW 06 HS	S	PN 630	10	10	15	30	22.5	19
XSA NW 08 HS	S	PN 630	12	12	17	32	24.5	22
XSA NW 10 HS	S	PN 630	14	14	19	35	27.0	24
XSA NW 13 HS	S	PN 400	16	16	21	35	26.6	27
XSA NW 16 HS	S	PN 400	20	20	26	40	29.5	32
XSA NW 20 HS	S	PN 400	25	25	31	44	32.0	41
XSA NW 25 HS	S	PN 400	30	30	36	49	35.5	46
XSA NW 32 HS	S	PN 315	38	38	44	54	38.0	55

系列: LL=特轻系列 L=轻系列 S=重系列

焊接式直角接头

连接1: 适用于公制钢管的焊接

连接2: 公制外螺纹

密封形式: 24°内锥面密封

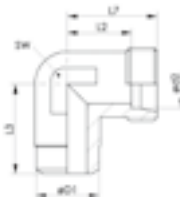

XWSA

订货号	系列	工作压力 bar	Ød2 mm	ØD1 mm	L2 mm	L3 mm	L7 mm	SW mm
XWSA NW 04 HL	L	PN 315	6	10	12.0	19	19	12
XWSA NW 06 HL	L	PN 315	8	12	14.0	23	21	12
XWSA NW 08 HL	L	PN 315	10	14	15.0	24	22	14
XWSA NW 10 HL	L	PN 315	12	16	17.0	25	24	17
XWSA NW 13 HL	L	PN 315	15	19	21.0	30	28	19
XWSA NW 16 HL	L	PN 315	18	22	23.5	33	31	24
XWSA NW 20 HL	L	PN 160	22	27	27.5	37	35	27
XWSA NW 25 HL	L	PN 160	28	32	30.5	42	38	36
XWSA NW 32 HL	L	PN 160	35	40	34.5	49	40	41
XWSA NW 40 HL	L	PN 160	42	46	40.0	57	51	50
XWSA NW 03 HS	S	PN 630	6	11	16.0	23	23	12
XWSA NW 04 HS	S	PN 630	8	13	17.0	24	24	14
XWSA NW 06 HS	S	PN 630	10	15	17.5	25	25	17
XWSA NW 08 HS	S	PN 630	12	17	21.5	29	29	17
XWSA NW 10 HS	S	PN 630	14	19	22.0	30	30	19
XWSA NW 13 HS	S	PN 400	16	21	24.5	33	33	24
XWSA NW 16 HS	S	PN 400	20	26	26.5	37	37	27
XWSA NW 20 HS	S	PN 400	25	31	30.0	42	42	36
XWSA NW 25 HS	S	PN 400	30	36	35.5	49	49	41
XWSA NW 32 HS	S	PN 315	38	44	41.0	57	57	50

系列: LL=特轻系列 L=轻系列 S=重系列

焊接式隔壁直通接头

连接1: 公制外螺纹
密封形式: 24°内锥面密封
连接2: 公制外螺纹
密封形式: 24°内锥面密封

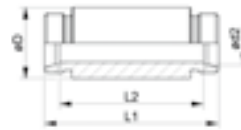

XSE



订货号	系列	压力 bar	Ød2 mm	管外径Ø mm	ØD mm	L1 mm	L2 mm
XSE NW 04 HL	L	PN 315	6	6	18	70	56
XSE NW 06 HL	L	PN 315	8	8	20	70	56
XSE NW 08 HL	L	PN 315	10	10	22	72	58
XSE NW 10 HL	L	PN 315	12	12	25	72	58
XSE NW 13 HL	L	PN 315	15	15	28	84	70
XSE NW 16 HL	L	PN 315	18	18	32	84	69
XSE NW 20 HL	L	PN 160	22	22	36	88	73
XSE NW 25 HL	L	PN 160	28	28	40	88	73
XSE NW 32 HL	L	PN 160	35	35	50	92	71
XSE NW 40 HL	L	PN 160	42	42	60	92	70
XSE NW 03 HS	S	PN 630	6	6	20	74	60
XSE NW 04 HS	S	PN 630	8	8	22	74	60
XSE NW 06 HS	S	PN 630	10	10	25	74	59
XSE NW 08 HS	S	PN 630	12	12	28	74	59
XSE NW 10 HS	S	PN 630	14	14	30	88	72
XSE NW 13 HS	S	PN 400	16	16	35	88	71
XSE NW 16 HS	S	PN 400	20	20	38	92	71
XSE NW 20 HS	S	PN 400	25	25	45	96	72
XSE NW 25 HS	S	PN 400	30	30	50	100	73
XSE NW 32 HS	S	PN 315	38	38	60	104	72

系列: LL=特轻系列 L=轻系列 S=重系列

转换接头

结构形式: 短
连接1: BSP标准外螺纹
密封形式: B型
连接2: BSP内螺纹

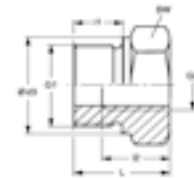

RIK



订货号	工作压力 bar	G1	G2	Ød3 mm	i1 mm	i2 mm	L mm	SW mm
RIK NW 10 03	PN 400	G 3/8" -19	G 1/8" -28	22.0	12	9	22.5	22
RIK NW 13 03	PN 400	G 1/2" -14	G 1/8" -28	26.0	14	9	24.0	27
RIK NW 13 06	PN 315	G 1/2" -14	G 1/4" -19	26.0	14	13	24.0	27
RIK NW 20 06	PN 315	G 3/4" -14	G 1/4" -19	32.0	16	13	26.0	32
RIK NW 20 10	PN 315	G 3/4" -14	G 3/8" -19	32.0	16	14	26.0	32
RIK NW 25 06	PN 315	G 1" -11	G 1/4" -19	39.0	18	14	29.0	41
RIK NW 25 10	PN 315	G 1" -11	G 3/8" -19	39.0	18	14	29.0	41
RIK NW 25 13	PN 315	G 1" -11	G 1/2" -14	39.0	18	16	29.0	41
RIK NW 32 13	PN 160	G 1.1/4" -11	G 1/2" -14	49.0	20	16	32.0	50
RIK NW 32 20	PN 160	G 1.1/4" -11	G 3/4" -14	49.0	20	18	32.0	60
RIK NW 40 13	PN 160	G 1.1/2" -11	G 1/2" -14	55.0	22	16	36.0	55
RIK NW 40 20	PN 160	G 1.1/2" -11	G 3/4" -14	55.0	22	18	36.0	55
RIK NW 40 25	PN 160	G 1.1/2" -11	G 1" -11	55.0	22	20	36.0	55

G1=接口螺纹 G2=接口螺纹

转换接头

RIL

结构形式：长
 连接1：BSP标准外螺纹
 密封形式：B型
 连接2：BSP内螺纹



订货号	工作压力 bar	Ød1 mm	G1	G2	Ød3 mm	i1 mm	i2 mm	L mm	SW mm
RIL NW 03 06	PN 400	4	G 1/8" -28	G 1/4" -19	14	8	17.0	31	19
RIL NW 03 10	PN 400	4	G 1/8" -28	G 3/8" -19	14	8	17.0	32	24
RIL NW 06 03	PN 400	5	G 1/4" -19	G 1/8" -28	18	12	12.0	28	19
RIL NW 06 06	PN 400	5	G 1/4" -19	G 1/4" -19	18	12	17.0	35	19
RIL NW 06 10	PN 400	5	G 1/4" -19	G 3/8" -19	18	12	17.0	36	24
RIL NW 06 13	PN 400	5	G 1/4" -19	G 1/2" -14	18	12	20.0	40	27
RIL NW 06 20	PN 315	5	G 1/4" -19	G 3/4" -14	18	12	22.0	43	36
RIL NW 10 06	PN 400	8	G 3/8" -19	G 1/4" -19	22	12	17.0	36	22
RIL NW 10 10	PN 400	8	G 3/8" -19	G 3/8" -19	22	12	17.0	35.5	24
RIL NW 10 13	PN 400	8	G 3/8" -19	G 1/2" -14	22	12	20.0	41	27
RIL NW 10 20	PN 315	8	G 3/8" -19	G 3/4" -14	22	12	22.0	44	36
RIL NW 13 10	PN 315	12	G 1/2" -14	G 3/8" -19	26	14	17.0	36	27
RIL NW 13 13	PN 315	12	G 1/2" -14	G 1/2" -14	26	14	20.0	42	27
RIL NW 13 20	PN 315	12	G 1/2" -14	G 3/4" -14	26	14	22.0	46	36
RIL NW 13 25	PN 315	12	G 1/2" -14	G 1" -11	26	14	24.5	49	41
RIL NW 13 32	PN 160	10	G 1/2" -14	G 1"1/4 -11	26	14	26.5	53	55
RIL NW 20 13	PN 315	16	G 3/4" -14	G 1/2" -14	32	16	20.0	41	32
RIL NW 20 20	PN 315	16	G 3/4" -14	G 3/4" -14	32	16	22.0	46	36
RIL NW 20 25	PN 315	16	G 3/4" -14	G 1" -11	32	16	24.5	51	41
RIL NW 20 32	PN 160	16	G 3/4" -14	G 1"1/4 -11	32	16	26.5	55	55
RIL NW 20 40	PN 160	16	G 3/4" -14	G 1"1/2 -11	32	16	28.5	57	60
RIL NW 25 20	PN 315	20	G 1" -11	G 3/4" -14	39	18	22.0	47	41
RIL NW 25 32	PN 160	20	G 1" -11	G 1"1/4 -11	39	18	26.5	57	55
RIL NW 25 40	PN 160	20	G 1" -11	G 1"1/2 -11	39	18	28.5	59	60
RIL NW 32 25	PN 160	25	G 1"1/4 -11	G 1" -11	49	20	24.5	52	50
RIL NW 32 40	PN 160	25	G 1"1/4 -11	G 1"1/2 -11	49	20	28.5	60	60
RIL NW 40 32	PN 160	32	G 1"1/2 -11	G 1"1/4 -11	55	22	26.5	58	55
RIL NW 50 40	PN 160	40	G 2" -11	G 1"1/2 -11	68	24	28.5	62	70

G1=接口螺纹 G2=接口螺纹

转换接头

RIK-ED

结构形式：短
 连接1：BSP标准外螺纹
 密封形式：E型
 连接2：BSP内螺纹



订货号	工作压力 bar	G1	G2	Ød3 mm	i1 mm	i2 mm	L mm	SW mm
RIK NW 10 03 ED	PN 400	G 3/8" -19	G 1/8" -28	21.9	12	9	22.5	22
RIK NW 13 03 ED	PN 400	G 1/2" -14	G 1/8" -28	26.9	14	9	24.0	27
RIK NW 13 06 ED	PN 400	G 1/2" -14	G 1/4" -19	26.9	14	14	24.0	27
RIK NW 20 06 ED	PN 315	G 3/4" -14	G 1/4" -19	31.9	16	14	26.0	32
RIK NW 20 10 ED	PN 315	G 3/4" -14	G 3/8" -19	31.9	16	14	26.0	32
RIK NW 25 06 ED	PN 315	G 1" -11	G 1/4" -19	39.9	18	14	29.0	41
RIK NW 25 10 ED	PN 315	G 1" -11	G 3/8" -19	39.9	18	14	29.0	41
RIK NW 25 13 ED	PN 315	G 1" -11	G 1/2" -14	39.9	18	16	29.0	41
RIK NW 32 13 ED	PN 315	G 1.1/4" -11	G 1/2" -14	49.9	20	16	32.0	50
RIK NW 32 20 ED	PN 315	G 1.1/4" -11	G 3/4" -14	49.9	20	18	32.0	50
RIK NW 40 13 ED	PN 250	G 1.1/2" -11	G 1/2" -14	54.9	22	16	36.0	55
RIK NW 40 20 ED	PN 250	G 1.1/2" -11	G 3/4" -14	54.9	22	18	36.0	55
RIK NW 40 25 ED	PN 250	G 1.1/2" -11	G 1" -11	54.9	22	20	36.0	55

G1=接口螺纹 G2=接口螺纹

转换接头

结构形式：长
 连接1：BSP标准外螺纹
 密封形式：E型
 连接2：BSP内螺纹

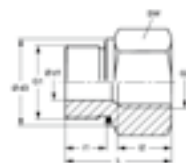

RIL-ED

订货号	工作压力 bar	Ød1 mm	G1	G2	Ød3 mm	i1 mm	i2 mm	L mm	SW mm
RIL NW 03 06 ED	PN 400	4	G 1/8" -28	G 1/4" -19	13.9	8	17.0	31	19
RIL NW 03 10 ED	PN 400	4	G 1/8" -28	G 3/8" -19	13.9	8	17.0	32	24
RIL NW 06 03 ED	PN 400	5	G 1/4" -19	G 1/8" -28	18.9	12	12.0	28	19
RIL NW 06 10 ED	PN 400	5	G 1/4" -19	G 3/8" -19	18.9	12	17.0	36	24
RIL NW 06 13 ED	PN 400	5	G 1/4" -19	G 1/2" -14	18.9	12	20.0	40	27
RIL NW 06 20 ED	PN 400	5	G 1/4" -19	G 3/4" -14	18.9	12	22.0	43	36
RIL NW 10 06 ED	PN 400	8	G 3/8" -19	G 1/4" -19	21.9	12	17.0	36	22
RIL NW 10 13 ED	PN 400	8	G 3/8" -19	G 1/2" -14	21.9	12	20.0	41	27
RIL NW 10 20 ED	PN 315	8	G 3/8" -19	G 3/4" -14	21.9	12	22.0	44	36
RIL NW 13 10 ED	PN 400	12	G 1/2" -14	G 3/8" -19	26.9	14	17.0	36	27
RIL NW 13 20 ED	PN 315	12	G 1/2" -14	G 3/4" -14	26.9	14	22.0	46	36
RIL NW 13 25 ED	PN 315	12	G 1/2" -14	G 1" -11	26.9	14	24.5	49	41
RIL NW 13 32 ED	PN 315	10	G 1/2" -14	G 1.1/4" -11	26.9	14	26.5	53	55
RIL NW 20 13 ED	PN 315	16	G 3/4" -14	G 1/2" -14	31.9	16	20.0	41	32
RIL NW 20 25 ED	PN 315	16	G 3/4" -14	G 1" -11	31.9	16	24.5	51	41
RIL NW 20 32 ED	PN 315	16	G 3/4" -14	G 1"1/4 -11	31.9	16	26.5	55	55
RIL NW 20 40 ED	PN 250	16	G 3/4" -14	G 1"1/2 -11	31.9	16	28.5	57	60
RIL NW 25 20 ED	PN 315	20	G 1" -11	G 3/4" -14	39.9	18	22.0	47	41
RIL NW 25 32 ED	PN 315	20	G 1" -11	G 1"1/4 -11	39.9	18	26.5	57	55
RIL NW 25 40 ED	PN 250	20	G 1" -11	G 1"1/2 -11	39.9	18	28.5	59	60
RIL NW 32 25 ED	PN 315	25	G 1"1/4 -11	G 1" -11	49.9	20	24.5	52	50
RIL NW 32 40 ED	PN 250	25	G 1"1/4 -11	G 1"1/2 -11	49.9	20	28.5	60	60
RIL NW 40 32 ED	PN 250	32	G 1.1/2" -11	G 1.1/4" -11	54.9	22	26.5	58	55
RIL NW 50 40 ED	PN 160	40	G 2" -11	G 1"1/2 -11	69.9	24	28.5	65.5	70

G1=接口螺纹 G2=接口螺纹

转换接头

结构形式：短
 连接1：公制外螺纹
 密封形式：B型
 连接2：公制内螺纹

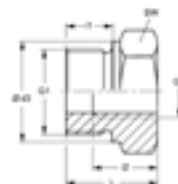

RIK-M

订货号	工作压力 bar	G1	G2	Ød3 mm	i1 mm	i2 mm	L mm	SW mm
RIK M 14 12-1	PN 400	M 14x1.5	M 12x1	19.0	12	10	20.0	24
RIK M 16 12	PN 400	M 16x1.5	M 12x1.5	21.0	12	10	24.0	27
RIK M 16 12-1	PN 400	M 16x1.5	M 12x1	27.0	12	12	24.0	27
RIK M 22 12	PN 400	M 22x1.5	M 12x1.5	27.0	14	12	24.0	27
RIK M 22 14	PN 400	M 22x1.5	M 14x1.5	27.0	14	12	24.0	27

G1=接口螺纹 G2=接口螺纹

转换接头

结构形式：长
 连接1：公制外螺纹
 密封形式：B型
 连接2：公制内螺纹



RIL-M

订货号	工作压力 bar	Ød1 mm	G1	G2	Ød3 mm	i1 mm	i2 mm	L mm	SW mm
RIL M 18 22	PN 250	8	M 18 x 1.5	M 22 x 1.5	23	12	20	41	32

G1=接口螺纹 G2=接口螺纹

转换接头

结构形式：长
 连接1：BSP标准外螺纹
 密封形式：B型
 连接2：公制内螺纹

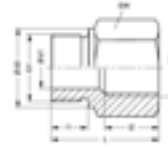

RIL R-M



订货号	工作压力 bar	Ød1 mm	G1	G2	Ød3 mm	i1 mm	i2 mm	L mm	SW mm
RIL NW 13 M 12	PN 250	10.5	G 1/2" -14	M 12 x 1.5	26	14	18	26.5	27
RIL NW 20 M 26	PN 250	16	G 3/4" -14	M 26 x 1.5	32	16.5	20.0	46	36
RIL NW 25 M 22	PN 250	20	G 1" -11	M 22 x 1.5	39	18	18	29	41

G1=接口螺纹 G2=接口螺纹

内螺纹管接头

连接1：BSP内螺纹
 密封形式：A型
 连接2：公制外螺纹
 密封形式：24°内锥面密封

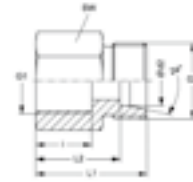

XGAR



订货号	系列	工作压力 bar	Ød2 mm	G1	G2	i mm	L1 mm	L2 mm	SW mm
XGAR NW 04 HL	L	PN 315	6	G 1/8" -28	M 12 x 1.5	12.0	26.0	19.0	14
XGAR NW 04 HL 1/4	L	PN 315	6	G 1/4" -19	M 12 x 1.5	12.0	31.0	24.0	19
XGAR NW 04 HL 3/8	L	PN 315	6	G 3/8" -19	M 12 x 1.5	17.0	32.0	25.0	22
XGAR NW 06 HL	L	PN 315	8	G 1/4" -19	M 14 x 1.5	17.0	31.0	24.0	19
XGAR NW 06 HL 3/8	L	PN 315	8	G 3/8" -19	M 14 x 1.5	17.0	32.0	25.0	22
XGAR NW 06 HL 1/2	L	PN 315	8	G 1/2" -14	M 14 x 1.5	20.0	36.0	29.0	27
XGAR NW 08 HL	L	PN 315	10	G 1/4" -19	M 16 x 1.5	17.0	32.0	25.0	19
XGAR NW 08 HL 3/8	L	PN 315	10	G 3/8" -19	M 16 x 1.5	17.0	33.0	26.0	22
XGAR NW 08 HL 1/2	L	PN 315	10	G 1/2" -14	M 16 x 1.5	20.0	37.0	30.0	27
XGAR NW 10 HL 1/4	L	PN 315	12	G 1/4" -19	M 18 x 1.5	17.0	32.0	25.0	19
XGAR NW 10 HL	L	PN 315	12	G 3/8" -19	M 18 x 1.5	17.0	33.0	26.0	22
XGAR NW 10 HL 1/2	L	PN 315	12	G 1/2" -14	M 18 x 1.5	20.0	37.0	30.0	27
XGAR NW 13 HL 3/8	L	PN 315	15	G 3/8" -19	M 22 x 1.5	17.0	34.0	27.0	24
XGAR NW 13 HL	L	PN 315	15	G 1/2" -14	M 22 x 1.5	20.0	38.0	31.0	27
XGAR NW 16 HL	L	PN 315	18	G 1/2" -14	M 26 x 1.5	20.0	38.0	30.5	27
XGAR NW 20 HL	L	PN 160	22	G 3/4" -14	M 30 x 2	22.0	43.0	35.5	32
XGAR NW 25 HL	L	PN 160	28	G 1" -11	M 36 x 2	24.5	45.5	38.0	41
XGAR NW 32 HL	L	PN 160	35	G 1.1/4" -11	M 45 x 2	26.5	51.5	41.0	50
XGAR NW 40 HL	L	PN 160	42	G 1.1/2" -11	M 52 x 2	28.5	53.5	42.5	55
XGAR NW 03 HS	S	PN 400	6	G 1/4" -19	M 14 x 1.5	17.0	33.0	26.0	19
XGAR NW 04 HS	S	PN 400	8	G 1/4" -19	M 16 x 1.5	17.0	33.0	26.0	19
XGAR NW 06 HS	S	PN 400	10	G 3/8" -19	M 18 x 1.5	17.0	34.0	26.5	24
XGAR NW 08 HS	S	PN 400	12	G 3/8" -19	M 20 x 1.5	17.0	34.0	25.5	24
XGAR NW 10 HS	S	PN 400	14	G 1/2" -14	M 22 x 1.5	20.0	40.0	32.0	27
XGAR NW 13 HS	S	PN 400	16	G 1/2" -14	M 24 x 1.5	20.0	40.0	31.5	27
XGAR NW 16 HS	S	PN 315	20	G 3/4" -14	M 30 x 2	22.0	45.0	34.5	36
XGAR NW 20 HS	S	PN 315	25	G 1" -11	M 36 x 2	24.5	49.5	37.5	41
XGAR NW 25 HS	S	PN 315	30	G 1.1/4" -11	M 42 x 2	26.5	55.5	42.0	50
XGAR NW 32 HS	S	PN 250	38	G 1.1/2" -11	M 52 x 2	28.5	59.5	43.5	60

系列：LL=特轻系列 L=轻系列 S=重系列；G1=接口螺纹 G2=接口螺纹

内螺纹管接头

连接1: 公制内螺纹
密封形式: A型
连接2: 公制外螺纹
密封形式: 24°内锥面密封

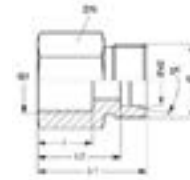

XGAM



订货号	系列	工作压力 bar	Ød2 mm	G1	管外径 mm	G2	i mm	L1 mm	L2 mm	SW mm
XGAM NW 04 HL	L	PN 315	6	M 10 x 1	6	M 12 x 1.5	12.5	26.5	19.5	14
XGAM NW 04 HL 22	L	PN 315	6	M 22 x 1.5	6	M 12 x 1.5	19.0	35.0	28.0	27
XGAM NW 06 HL	L	PN 315	8	M 12 x 1.5	8	M 14 x 1.5	17.0	31.0	24.0	17
XGAM NW 06 HL 22	L	PN 315	8	M 22 x 1.5	8	M 14 x 1.5	19.0	35.0	29.0	27
XGAM NW 08 HL	L	PN 315	10	M 14 x 1.5	10	M 16 x 1.5	17.0	32.0	25.0	19
XGAM NW 08 HL 22	L	PN 315	10	M 22 x 1.5	10	M 16 x 1.5	19.0	36.0	29.0	27
XGAM NW 10 HL	L	PN 315	12	M 16 x 1.5	12	M 18 x 1.5	17.0	33.0	26.0	22
XGAM NW 10 HL 18	L	PN 315	12	M 18 x 1.5	12	M 18 x 1.5	17.0	34.0	27.0	24
XGAM NW 10 HL 22	L	PN 315	12	M 22 x 1.5	12	M 18 x 1.5	19.0	36.0	29.0	27
XGAM NW 13 HL	L	PN 315	15	M 18 x 1.5	15	M 22 x 1.5	17.0	35.0	28.0	24
XGAM NW 13 HL 22	L	PN 315	15	M 22 x 1.5	15	M 22 x 1.5	19.0	37.0	30.0	27
XGAM NW 16 HL	L	PN 315	18	M 22 x 1.5	18	M 26 x 1.5	19.0	37.0	29.5	27
XGAM NW 20 HL	L	PN 160	22	M 26 x 1.5	22	M 30 x 2	21.0	42.0	34.5	32
XGAM NW 25 HL	L	PN 160	28	M 33 x 2	28	M 36 x 2	24.0	45.0	37.5	41
XGAM NW 32 HL	L	PN 160	35	M 42 x 2	35	M 45 x 2	26.0	51.0	40.5	55
XGAM NW 40 HL	L	PN 160	42	M 48 x 2	42	M 52 x 2	28.0	53.0	42.0	60
XGAM NW 03 HS	S	PN 400	6	M 12 x 1.5	6	M 14 x 1.5	17.0	33.0	26.0	17
XGAM NW 04 HS	S	PN 400	8	M 14 x 1.5	8	M 16 x 1.5	17.0	33.0	26.0	19
XGAM NW 06 HS	S	PN 400	10	M 16 x 1.5	10	M 18 x 1.5	17.0	34.0	26.5	22
XGAM NW 08 HS	S	PN 400	12	M 18 x 1.5	12	M 20 x 1.5	17.0	35.0	27.5	24
XGAM NW 10 HS	S	PN 400	14	M 20 x 1.5	14	M 22 x 1.5	19.0	39.0	31.0	27
XGAM NW 13 HS	S	PN 400	16	M 22 x 1.5	16	M 24 x 1.5	19.0	39.0	30.5	30
XGAM NW 16 HS	S	PN 315	20	M 27 x 2	20	M 30 x 2	22.0	45.0	34.5	36
XGAM NW 20 HS	S	PN 315	25	M 33 x 2	25	M 36 x 2	24.0	49.0	37.0	41
XGAM NW 25 HS	S	PN 315	30	M 42 x 2	30	M 42 x 2	26.0	55.0	41.5	55
XGAM NW 32 HS	S	PN 250	38	M 48 x 2	38	M 52 x 2	28.0	59.0	43.0	60

系列: LL=特轻系列 L=轻系列 S=重系列; G1=接口螺纹 G2=接口螺纹

压力表接头

接头1: BSP内螺纹
密封形式: 铜垫
连接2: 公制外螺纹
密封形式: 24°内锥面密封

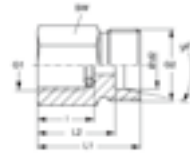

XMVR



订货号	系列	工作压力 bar	Ød2 mm	G1	G2	i mm	L1 mm	L2 mm	SW mm
XMVR 04 LL	LL	PN 100	4	G 1/4" -19	M 8 x 1	14.5	27	23.0	19
XMVR NW 04 HL	L	PN 315	6	G 1/4" -19	M 12 x 1.5	14.5	29	22.0	19
XMVR NW 06 HL	L	PN 315	8	G 1/4" -19	M 14 x 1.5	14.5	29	22.0	19
XMVR NW 08 HL	L	PN 315	10	G 1/4" -19	M 16 x 1.5	14.5	30	23.0	19
XMVR NW 10 HL	L	PN 315	12	G 1/4" -19	M 18 x 1.5	14.5	30	23.0	19
XMVR NW 03 HS	S	PN 630	6	G 1/2" -14	M 14 x 1.5	20.0	38	31.0	27
XMVR NW 04 HS	S	PN 630	8	G 1/2" -14	M 16 x 1.5	20.0	38	31.0	27
XMVR NW 06 HS	S	PN 630	10	G 1/2" -14	M 18 x 1.5	20.0	38	30.5	27
XMVR NW 08 HS	S	PN 630	12	G 1/2" -14	M 20 x 1.5	20.0	38	30.5	27

系列: LL=特轻系列 L=轻系列 S=重系列; G1=接口螺纹 G2=接口螺纹

压力表接头

MVO

接头1: BSP内螺纹
 密封形式: 铜垫
 连接2: 公制外螺纹
 密封形式: 24°内锥面密封

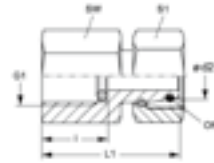

订货号	系列	工作压力 bar	Ød2 mm	G1	管外径Ø mm	i mm	L1 mm	SW mm	S1	OR
MVO NW 04 L	L	PN 315	6	G 1/4" -19	6	14.5	36.5	19	14	4.0 x 1.5
MVO NW 06 L	L	PN 315	8	G 1/4" -19	8	14.5	36.5	19	17	6.0 x 1.5
MVO NW 08 L	L	PN 315	10	G 1/4" -19	10	14.5	36.0	19	19	7.5 x 1.5
MVO NW 10 L	L	PN 315	12	G 1/4" -19	12	14.5	37.5	19	22	9.0 x 1.5
MVO NW 03 S 1/4	S	PN 630	6	G 1/4" -19	6	14.5	35.5	19	17	4.0 x 1.5
MVO NW 03 S	S	PN 630	6	G 1/2" -14	6	20.0	43.5	27	17	4.0 x 1.5
MVO NW 04 S 1/4	S	PN 630	8	G 1/4" -19	8	14.5	35.5	19	19	6.0 x 1.5
MVO NW 04 S	S	PN 630	8	G 1/2" -14	8	20.0	43.0	27	19	6.0 x 1.5
MVO NW 06 S 1/4	S	PN 630	10	G 1/4" -19	10	14.5	36.0	19	22	7.5 x 1.5
MVO NW 06 S	S	PN 630	10	G 1/2" -14	10	20.0	45.0	27	22	7.5 x 1.5
MVO NW 08 S 1/4	S	PN 630	12	G 1/4" -19	12	14.5	39.0	19	24	9.0 x 1.5
MVO NW 08 S	S	PN 630	12	G 1/2" -14	12	20.0	44.5	27	24	9.0 x 1.5

系列: LL=特轻系列 L=轻系列 S=重系列; G1=接口螺纹

铰接式管接头(低压)

XDWR

结构形式: 90°角
 连接1: BSP标准外螺纹
 密封形式: 密封唇边环
 连接2: 公制外螺纹
 密封形式: 24°内锥面密封



订货号	系列	工作压力 bar	Ød2 mm	G	管外径Ø mm	ØD mm	i mm	L1 mm	L2 mm	L4 mm	L7 mm	SW mm	S1	S2
XDWR NW 04 HL	L	PN 160	6	G 1/8" -28	6	14	8	24	12	12.5	19	19	6	6
XDWR NW 06 HL	L	PN 160	8	G 1/4" -19	8	18	12	30	16	14.5	21	22	8	8
XDWR NW 08 HL	L	PN 100	10	G 1/4" -19	10	18	12	30	16	15.5	22	22	8	8
XDWR NW 10 HL 1/4	L	PN 100	12	G 1/4" -19	12	18	12	37	18	15.5	22	22	8	8
XDWR NW 10 HL	L	PN 100	12	G 3/8" -19	12	22	12	37	18	18.0	25	27	10	10
XDWR NW 13 HL	L	PN 100	15	G 1/2" -14	15	26	14	42	21	22.0	29	32	12	12
XDWR NW 16 HL	L	PN 100	18	G 1/2" -14	18	26	14	46	23	21.5	29	36	12	12
XDWR NW 20 HL	L	PN 100	22	G 3/4" -14	22	32	16	58	28	28.5	36	46	17	17
XDWR NW 25 HL	L	PN 100	28	G 1" -11	28	39	18	64	32	31.5	39	50	22	22
XDWR NW 32 HL	L	PN 63	35	G 1.1/4" -11	35	49	20	76	37	35.5	46	60	27	27
XDWR NW 40 HL	L	PN 63	42	G 1.1/2" -11	42	55	22	85	42	40.0	51	70	32	32
XDWR NW 03 HS	S	PN 160	6	G 1/4" -19	6	18	12	30	16	16.5	23	22	8	8
XDWR NW 04 HS	S	PN 160	8	G 1/4" -19	8	18	12	30	16	16.5	23	22	8	8
XDWR NW 06 HS	S	PN 100	10	G 3/8" -19	10	22	12	37	18	18.5	26	27	10	10
XDWR NW 08 HS	S	PN 100	12	G 3/8" -19	12	22	12	37	18	18.5	26	27	10	10
XDWR NW 10 HS	S	PN 100	14	G 1/2" -14	14	26	14	42	21	23.0	31	32	12	12
XDWR NW 13 HS	S	PN 100	16	G 1/2" -14	16	26	14	46	23	22.5	31	36	12	12
XDWR NW 16 HS	S	PN 100	20	G 3/4" -14	20	32	16	58	28	27.5	38	46	17	17
XDWR NW 20 HS	S	PN 100	25	G 1" -11	25	39	18	64	32	31.0	43	50	22	22
XDWR NW 25 HS	S	PN 63	30	G 1.1/4" -11	30	49	20	76	37	36.5	50	60	27	27
XDWR NW 32 HS	S	PN 63	38	G 1.1/2" -11	38	55	22	85	42	41.0	57	70	32	32

系列: LL=特轻系列 L=轻系列 S=重系列; G=接口螺纹

铰接式管接头(低压)

结构形式: 90°角
 连接1: 公制圆柱管螺纹
 密封形式: 密封唇边环
 连接2: 公制外螺纹
 密封形式: 24°内锥面密封

XDWM



订货号	系列	工作压力 bar	Ød2 mm	G	管外径Ø mm	ØD mm	i mm	L1 mm	L2 mm	L4 mm	L7 mm	SW mm	S1	S2
XDWM NW 04 HL	L	PN 160	6	M 10 x 1	6	14	8	24	12	12.5	19	19	6	6
XDWM NW 06 HL	L	PN 160	8	M 12 x 1.5	8	17	12	30	15	14.5	21	22	6	6
XDWM NW 08 HL	L	PN 100	10	M 14 x 1.5	10	19	12	30	16	15.5	22	22	8	8
XDWM NW 10 HL	L	PN 100	12	M 16 x 1.5	12	21	12	37	18	18.0	25	27	10	10
XDWM NW 10 HL 18	L	PN 100	12	M 18 x 1.5	12	23	12	37	18	18.0	25	30	12	12
XDWM NW 13 HL	L	PN 100	15	M 18 x 1.5	15	23	12	40	20	22.0	26	30	12	12
XDWM NW 16 HL	L	PN 100	18	M 22 x 1.5	18	27	14	46	23	21.5	27	36	14	14
XDWM NW 20 HL	L	PN 100	22	M 26 x 1.5	22	31	16	51	25	26.0	33	41	17	17
XDWM NW 25 HL	L	PN 100	28	M 33 x 2	28	39	18	64	32	31.5	39	50	22	22
XDWM NW 32 HL	L	PN 63	35	M 42 x 2	35	49	20	76	37	35.5	46	60	27	27
XDWM NW 40 HL	L	PN 63	42	M 48 x 2	42	55	22	85	42	40.0	51	70	32	32
XDWM NW 03 HS	S	PN 160	6	M 12 x 1.5	6	17	12	30	15	16.5	23	22	6	6
XDWM NW 04 HS	S	PN 160	8	M 14 x 1.5	8	19	12	30	16	16.5	23	22	8	8
XDWM NW 06 HS	S	PN 100	10	M 16 x 1.5	10	21	12	37	18	18.5	26	27	10	10
XDWM NW 08 HS	S	PN 100	12	M 18 x 1.5	12	23	12	41	20	20.5	28	30	12	12
XDWM NW 10 HS	S	PN 100	14	M 20 x 1.5	14	25	14	42	21	23.0	31	32	12	12
XDWM NW 13 HS	S	PN 100	16	M 22 x 1.5	16	27	14	46	23	22.5	31	36	14	14
XDWM NW 16 HS	S	PN 100	20	M 27 x 2	20	32	16	58	28	27.5	38	46	17	17
XDWM NW 20 HS	S	PN 100	25	M 33 x 2	25	39	18	64	32	31.0	43	50	22	22
XDWM NW 25 HS	S	PN 63	30	M 42 x 2	30	49	20	76	37	36.5	50	60	27	27
XDWM NW 32 HS	S	PN 63	38	M 48 x 2	38	55	22	85	42	41.0	57	70	32	32

系列: LL=特轻系列 L=轻系列 S=重系列; G=接口螺纹

铰接式管接头

结构形式: 90°角
 连接1: BSP标准外螺纹
 密封形式: 密封唇边环
 连接2: 公制外螺纹
 密封形式: 24°内锥面密封

XSWR

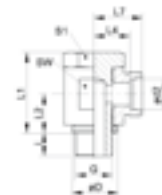

订货号	系列	工作压力 bar	Ød2 mm	G	管外径Ø mm	ØD mm	i mm	L1 mm	L2 mm	L4 mm	L7 mm	SW mm	S1
XSWR 04 LL	LL	PN 100	4	G 1/8" -28	4	14.5	6	21.0	10.0	11.5	15.5	14	14
XSWR 05 LL	LL	PN 100	5	G 1/8" -28	5	14.5	6	21.5	10.0	10.0	14.5	14	14
XSWR 06 LL	LL	PN 100	6	G 1/8" -28	6	14.5	6	21.5	10.0	10.0	14.5	14	14
XSWR 08 LL	LL	PN 100	8	G 1/8" -28	8	14.5	6	21.0	10.0	11.0	16.5	14	14
XSWR NW 13 HL 3/8	L	PN 250	15	G 3/8" -19	15	22.5	9	37.5	18.0	19.0	26.0	27	22

系列: LL=特轻系列 L=轻系列 S=重系列; G=接口螺纹

铰接式管接头体

结构形式: 90°角

连接1: 公制圆柱管螺纹

密封形式: 密封唇边环

连接2: 公制外螺纹

密封形式: 24°内锥面密封

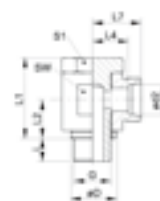

订货号	系列	工作压力 bar	Ød2 mm	G	管外径Ø mm	ØD mm	i mm	L1 mm	L2 mm	L4 mm	L7 mm	SW mm	S1
XSWM 04 LL	LL	PN 100	4	M 8 x 1	4	12.5	6	17.0	8	10.5	14.5	12	14
XSWM 05 LL	LL	PN 100	5	M 8 x 1	5	12.5	6	17.0	10	11.5	17.0	14	14
XSWM 06 LL	LL	PN 100	6	M 10 x 1	6	14.0	6	21.0	10	10.0	15.5	14	14
XSWM 08 LL	LL	PN 100	8	M 10 x 1	8	14.0	6	21.0	10	11.0	16.5	14	14
XSWM NW 04 HL 12	L	PN 250	6	M 12 x 1.5	6	17.0	9	27.5	13	12.5	19.5	17	17

系列: LL=特轻系列 L=轻系列 S=重系列; G=接口螺纹

铰接式管接头(高压)

结构形式: 90°角

连接1: BSP标准外螺纹

密封形式: G型

连接2: 公制外螺纹

密封形式: 24°内锥面密封

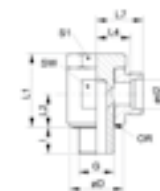

订货号	系列	工作压力 bar	Ød2 mm	G	ØD mm	i mm	L1 mm	L2 mm	L4 mm	L7 mm	SW mm	S1	OR
XSDOR 04 LL	LL	PN 100	4	G 1/8" -28	14.5	8.0	23.5	10.5	14.0	18.0	17	17	7.65 x 1.78
XSDOR 06 LL	LL	PN 100	6	G 1/8" -28	14.5	8.0	23.5	10.5	13.5	19.0	17	17	7.65 x 1.78
XSDOR 08 LL	LL	PN 100	8	G 1/8" -28	14.5	8.0	23.5	10.5	13.5	19.0	17	17	7.65 x 1.78
XSDOR NW 04 HL	L	PN 315	6	G 1/8" -28	14.0	8.0	24.0	10.5	12.0	19.0	17	17	7.65 x 1.78
XSDOR NW 06 HL	L	PN 315	8	G 1/4" -19	18.0	12.0	30.0	14.0	14.5	21.5	22	19	11.10 x 1.78
XSDOR NW 08 HL	L	PN 315	10	G 1/4" -19	18.0	12.0	30.0	14.0	15.5	22.5	22	19	11.10 x 1.78
XSDOR NW 10 HL 1/4	L	PN 315	12	G 1/4" -19	19.0	12.0	34.0	16.5	18.0	25.0	27	19	11.10 x 1.78
XSDOR NW 10 HL	L	PN 315	12	G 3/8" -19	22.0	12.0	36.0	16.5	18.0	25.0	27	24	14.00 x 1.78
XSDOR NW 10 HL 1/2	L	PN 315	12	G 1/2" -14	27.0	14.0	46.0	21.5	20.5	27.5	32	27	18.77 x 1.78
XSDOR NW 13 HL	L	PN 315	15	G 1/2" -14	26.0	12.0	45.0	21.5	21.5	28.5	32	30	18.77 x 1.78
XSDOR NW 16 HL	L	PN 315	18	G 1/2" -14	26.0	14.0	45.0	21.5	21.0	28.5	32	30	18.77 x 1.78
XSDOR NW 20 HL	L	PN 160	22	G 3/4" -14	32.0	16.0	53.0	24.0	27.5	35.0	41	36	23.81 x 2.62
XSDOR NW 25 HL	L	PN 160	28	G 1" -11	39.0	18.0	66.0	30.5	32.0	39.5	50	46	29.82 x 2.62
XSDOR NW 32 HL	L	PN 160	35	G 1.1/4" -11	49.0	20.0	76.0	35.5	36.0	46.5	60	55	37.77 x 2.62
XSDOR NW 40 HL	L	PN 160	42	G 1.1/2" -11	55.0	22.0	87.0	40.5	40.5	51.5	70	60	41.28 x 3.53
XSDOR NW 03 HS	S	PN 400	6	G 1/4" -19	18.0	12.0	30.0	14.0	16.5	23.5	22	19	11.10 x 1.78
XSDOR NW 04 HS	S	PN 400	8	G 1/4" -19	18.0	12.0	30.0	14.0	16.5	23.5	22	19	11.10 x 1.78
XSDOR NW 06 HS	S	PN 400	10	G 3/8" -19	22.0	12.0	36.0	16.5	18.5	26.0	27	24	14.00 x 1.78
XSDOR NW 08 HS	S	PN 400	12	G 3/8" -19	22.0	12.0	36.0	16.5	18.5	26.0	27	24	14.00 x 1.78
XSDOR NW 10 HS	S	PN 400	14	G 1/2" -14	26.0	14.0	45.0	21.5	22.5	30.5	32	30	18.77 x 1.78
XSDOR NW 13 HS	S	PN 315	16	G 1/2" -14	26.0	14.0	45.0	21.5	22.0	30.5	32	30	18.77 x 1.78
XSDOR NW 16 HS	S	PN 315	20	G 3/4" -14	32.0	16.0	53.0	24.0	26.5	37.0	41	36	23.81 x 2.62
XSDOR NW 20 HS	S	PN 250	25	G 1" -11	39.0	18.0	66.0	30.5	31.5	43.5	50	46	29.82 x 2.62
XSDOR NW 25 HS	S	PN 160	30	G 1.1/4" -11	49.0	20.0	76.0	35.5	37.0	50.5	60	55	37.77 x 2.62
XSDOR NW 32 HS	S	PN 160	38	G 1.1/2" -11	55.0	22.0	87.0	40.5	41.5	57.5	70	60	41.28 x 3.53

系列: LL=特轻系列 L=轻系列 S=重系列; G=接口螺纹

铰接式管接头(高压)

结构形式: 90°角
 连接1: 公制圆柱管螺纹
 密封形式: F型
 连接2: 公制外螺纹
 密封形式: 24°内锥面密封



XSDOM



订货号	系列	工作压力 bar	Ød2 mm	G	ØD mm	i mm	L1 mm	L2 mm	L4 mm	L7 mm	SW mm	S1	OR
XSDOM 06 LL	LL	PN 100	6	M 10 x 1	14.5	8.0	23.5	10.5	13.5	19.0	17	17	7.65 x 1.78
XSDOM 08 LL	LL	PN 100	8	M 10 x 1	14.5	8.0	23.5	10.5	13.5	19.0	17	17	7.65 x 1.78
XSDOM NW 04 HL	L	PN 315	6	M 10 x 1	14	8.0	24	10.5	12.0	19.0	17	17	7.65 x 1.78
XSDOM NW 06 HL	L	PN 315	8	M 12 x 1.5	17	12.0	30	14	14.5	21.5	22	19	11.10 x 1.78
XSDOM NW 08 HL	L	PN 315	10	M 14 x 1.5	19	12.0	30	14	15.5	22.5	22	19	11.10 x 1.78
XSDOM NW 10 HL	L	PN 315	12	M 16 x 1.5	21	12.0	36	16.5	18.0	25.0	27	24	14.00 x 1.78
XSDOM NW 10 HL 18	L	PN 315	12	M 18 x 1.5	23.5	12.0	35	16.5	18.0	25.0	27	24	18.77 x 1.78
XSDOM NW 13 HL	L	PN 315	15	M 18 x 1.5	23	12.0	39.5	18.5	21.5	28.5	30	27	18.77 x 1.78
XSDOM NW 16 HL	L	PN 315	18	M 22 x 1.5	27	14.0	45	21.5	21.0	28.5	32	30	18.77 x 1.78
XSDOM NW 20 HL	L	PN 160	22	M 26 x 1.5	31	16.0	53	24	27.5	35.0	41	36	23.81 x 2.62
XSDOM NW 25 HL	L	PN 160	28	M 33 x 2	39	18.0	66	30.5	32.0	39.5	50	46	29.82 x 2.62
XSDOM NW 32 HL	L	PN 160	35	M 42 x 2	49	20.0	76	35.5	36.0	46.5	60	55	37.77 x 2.62
XSDOM NW 40 HL	L	PN 160	42	M 48 x 2	55	22.0	87	40.5	40.5	51.5	70	60	41.28 x 3.53
XSDOM NW 03 HS	S	PN 400	6	M 12 x 1.5	17.5	12.0	30	14	16.5	23.5	22	19	11.10 x 1.78
XSDOM NW 04 HS	S	PN 400	8	M 14 x 1.5	19	12.0	30	14	16.5	23.5	22	19	11.10 x 1.78
XSDOM NW 06 HS	S	PN 400	10	M 16 x 1.5	21	12.0	35	16.5	18.5	26.0	27	24	14.00 x 1.78
XSDOM NW 08 HS	S	PN 400	12	M 18 x 1.5	23	12.0	39.5	18.5	20.0	27.5	30	27	18.77 x 1.78
XSDOM NW 10 HS	S	PN 400	14	M 20 x 1.5	25	14.0	43.5	20	22.5	30.5	32	30	18.77 x 1.78
XSDOM NW 13 HS	S	PN 315	16	M 22 x 1.5	27	14.0	45	21.5	22.0	30.5	32	30	18.77 x 1.78
XSDOM NW 16 HS	S	PN 315	20	M 27 x 2	32	16.0	53	24	26.5	37.0	41	36	23.81 x 2.62
XSDOM NW 20 HS	S	PN 250	25	M 33 x 2	39	18.0	66	30.5	31.5	43.5	50	46	29.82 x 2.62
XSDOM NW 25 HS	S	PN 160	30	M 42 x 2	49	20.0	76	35.5	37.0	50.5	60	55	37.77 x 2.62
XSDOM NW 32 HS	S	PN 160	38	M 48 x 2	55	22.0	87	40.5	41.5	57.5	70	60	41.28 x 3.53

系列: LL=特轻系列 L=轻系列 S=重系列; G=接口螺纹

铰接式管接头(高压)

结构形式: 90°角
 连接1: BSP标准外螺纹
 密封形式: 密封唇边环
 连接2: 公制外螺纹
 密封形式: 24°内锥面密封



XSDR



订货号	系列	工作压力 bar	Ød2 mm	G	ØD mm	i mm	L1 mm	L2 mm	L4 mm	L7 mm	SW mm	S1
XSDR NW 04 HL	L	PN 250	6	G 1/8" -28	14	8	24	10.5	12.0	19.0	17	17
XSDR NW 04 HL 1/4	L	PN 250	6	G 1/4" -19	18	12	30	14	14.5	21.5	22	19
XSDR NW 06 HL	L	PN 250	8	G 1/4" -19	18	12	30	14	14.5	21.5	22	19
XSDR NW 08 HL	L	PN 250	10	G 1/4" -19	18	12	30	14	15.5	22.5	22	19
XSDR NW 10 HL 1/4	L	PN 250	12	G 1/4" -19	18	12	30	15	15.5	22.5	22	19
XSDR NW 10 HL	L	PN 250	12	G 3/8" -19	22	12	36	16.5	18.0	25.0	27	24
XSDR NW 10 HL 1/2	L	PN 250	12	G 1/2" -14	26	14	45	21.5	20.5	28.5	32	30
XSDR NW 13 HL	L	PN 250	15	G 1/2" -14	26	14	45	21.5	21.5	28.5	32	30
XSDR NW 16 HL	L	PN 250	18	G 1/2" -14	26	14	45	21.5	21.0	28.5	32	30
XSDR NW 20 HL	L	PN 160	22	G 3/4" -14	32	16	53	24	27.5	35.0	41	36
XSDR NW 25 HL	L	PN 160	28	G 1" -11	39	18	66	30.5	32.0	39.5	50	46
XSDR NW 32 HL	L	PN 160	35	G 1.1/4" -11	49	20	76	35.5	36.0	46.5	60	55
XSDR NW 40 HL	L	PN 160	42	G 1.1/2" -11	55	22	87	40.5	40.5	51.5	70	60
XSDR NW 03 HS	S	PN 315	6	G 1/4" -19	18	12	30	14	16.5	23.5	22	19
XSDR NW 04 HS	S	PN 315	8	G 1/4" -19	18	12	30	14	16.5	23.5	22	19
XSDR NW 06 HS	S	PN 315	10	G 3/8" -19	22	12	36	16.5	18.5	26.0	27	24
XSDR NW 08 HS	S	PN 315	12	G 3/8" -19	22	12	36	16.5	18.5	26.0	27	24
XSDR NW 10 HS	S	PN 315	14	G 1/2" -14	26	14	45	21.5	22.5	30.5	32	30
XSDR NW 13 HS	S	PN 315	16	G 1/2" -14	26	14	45	21.5	22.0	30.5	32	30
XSDR NW 16 HS	S	PN 160	20	G 3/4" -14	32	16	53	24	26.5	37.0	41	36
XSDR NW 20 HS	S	PN 160	25	G 1" -11	39	18	66	30.5	31.5	43.5	50	46
XSDR NW 25 HS	S	PN 160	30	G 1.1/4" -11	49	20	76	35.5	37.0	50.5	60	55
XSDR NW 32 HS	S	PN 160	38	G 1.1/2" -11	55	22	87	40.5	41.5	57.5	70	60

系列: LL=特轻系列 L=轻系列 S=重系列; G=接口螺纹

铰接式管接头(高压)

结构形式: 90°角

连接1: 公制圆柱管螺纹

密封形式: 密封唇边环

连接2: 公制外螺纹

密封形式: 24°内锥面密封

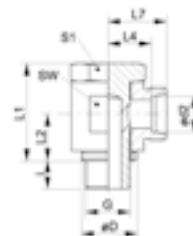

XSDM



订货号	系列	工作压力 bar	Ød2 mm	G	ØD mm	i mm	L1 mm	L2 mm	L4 mm	L7 mm	SW mm	S1
XSDM NW 04 HL	L	PN 250	6	M 10 x 1	14	8	24.0	10.5	12.0	19.0	17	17
XSDM NW 06 HL	L	PN 250	8	M 12 x 1.5	17	12	30.0	14.0	14.5	21.5	22	19
XSDM NW 08 HL	L	PN 250	10	M 14 x 1.5	19	12	30.0	14.0	15.5	22.5	22	19
XSDM NW 10 HL	L	PN 250	12	M 16 x 1.5	21	12	36.0	16.5	18.0	25.0	27	24
XSDM NW 10 HL 18	L	PN 250	12	M 18 x 1.5	23	12	38.0	17.0	13.5	25.0	30	27
XSDM NW 13 HL	L	PN 250	15	M 18 x 1.5	23	12	39.5	18.5	20.5	27.5	30	27
XSDM NW 16 HL	L	PN 250	18	M 22 x 1.5	27	14	45.0	21.5	21.0	28.5	32	30
XSDM NW 20 HL	L	PN 160	22	M 26 x 1.5	31	16	53.0	24.0	27.5	35.0	41	36
XSDM NW 25 HL	L	PN 160	28	M 33 x 2	39	18	66.0	30.5	32.0	39.5	50	46
XSDM NW 32 HL	L	PN 160	35	M 42 x 2	49	20	76.0	35.5	36.0	46.5	60	55
XSDM NW 40 HL	L	PN 160	42	M 48 x 2	55	22	87.0	40.5	40.5	51.5	70	60
XSDM NW 03 HS	S	PN 315	6	M 12 x 1.5	17	12	30.0	14.0	16.5	23.5	22	19
XSDM NW 04 HS	S	PN 315	8	M 14 x 1.5	19	12	30.0	14.0	16.5	23.5	22	19
XSDM NW 06 HS	S	PN 315	10	M 16 x 1.5	21	12	36.0	16.5	18.5	26.0	27	24
XSDM NW 08 HS	S	PN 315	12	M 18 x 1.5	23	12	39.5	18.5	20.0	27.5	30	27
XSDM NW 10 HS	S	PN 315	14	M 20 x 1.5	25	14	43.5	20.0	22.5	30.5	32	30
XSDM NW 13 HS	S	PN 315	16	M 22 x 1.5	27	14	45.0	21.5	22.0	30.5	32	30
XSDM NW 16 HS	S	PN 160	20	M 27 x 2	32	16	53.0	24.0	26.5	37.0	41	36
XSDM NW 20 HS	S	PN 160	25	M 33 x 2	39	18	66.0	30.5	31.5	43.5	50	46
XSDM NW 25 HS	S	PN 160	30	M 42 x 2	49	20	76.0	35.5	37.0	50.5	60	55
XSDM NW 32 HS	S	PN 160	38	M 48 x 2	55	22	87.0	40.5	41.5	57.5	70	60

系列: LL=特轻系列 L=轻系列 S=重系列; G=接口螺纹

堵头

结构形式: 不带螺母

密封形式: 24°锥带O型密封圈



BZL + BZS



订货号	系列	工作压力 bar	Ød1 mm	Ød2 mm	L1 mm	OR
BZL NW 04	L	PN 315	6.6	6	18.5	4.0 x 1.5
BZL NW 06	L	PN 315	8.5	8	18.0	6.0 x 1.5
BZL NW 08	L	PN 315	10.6	10	19.5	7.5 x 1.5
BZL NW 10	L	PN 315	12.6	12	19.0	9.0 x 1.5
BZL NW 13	L	PN 315	15.5	15	19.0	12.0 x 2.0
BZL NW 16	L	PN 315	18.6	18	22.0	15.0 x 2.0
BZL NW 20	L	PN 160	22.6	22	22.0	20.0 x 2.0
BZL NW 25	L	PN 160	28.5	28	23.5	26.0 x 2.0
BZL NW 32	L	PN 160	36.0	35	27.0	32.0 x 2.5
BZL NW 40	L	PN 160	43.0	42	27.5	38.0 x 2.5
BZS NW 10	S	PN 630	14.5	14	21.0	10.0 x 2.0
BZS NW 13	S	PN 400	16.5	16	22.0	12.0 x 2.0
BZS NW 16	S	PN 400	20.9	20	26.5	16.3 x 2.4
BZS NW 20	S	PN 400	25.9	25	27.5	20.3 x 2.4
BZS NW 25	S	PN 400	31.0	30	28.5	25.3 x 2.4
BZS NW 32	S	PN 315	39.0	38	32.5	33.3 x 2.4

系列: LL=特轻系列 L=轻系列 S=重系列

内六角螺堵

连接1: BSP标准外螺纹
密封形式: E型

VHR 90 ED

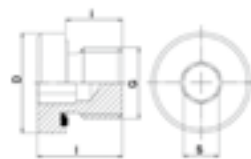

订货号	工作压力 bar	G	D mm	i mm	l mm	S mm
VHR 90-1/8 ED	PN 400	G 1/8" -28	14	8	12	5
VHR 90-1/4 ED	PN 400	G 1/4" -19	19	12	17	6
VHR 90-3/8 ED	PN 400	G 3/8" -19	22	12	17	8
VHR 90-1/2 ED	PN 400	G 1/2" -14	27	14	19	10
VHR 90-3/4 ED	PN 400	G 3/4" -14	32	16	21	12
VHR 90-1 ED	PN 400	G 1" -11	40	16	22.5	17
VHR 90-1 1/4 ED	PN 315	G 1.1/4" -11	50	16	22.5	22
VHR 90-1 1/2 ED	PN 315	G 1.1/2" -11	55	16	22.5	24
VHR 90-2 ED	PN 315	G 2" -11	72	24	34.5	32

G=接口螺纹

内六角螺堵

连接1: 公制外螺纹
密封形式: E型

VHM 90 ED

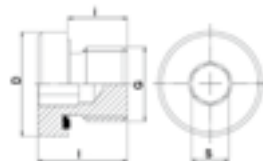

订货号	工作压力 bar	G	D mm	i mm	l mm	S mm
VHM 90-08 ED	PN 400	M 8 x 1	12	8	12	4
VHM 90-10 ED	PN 400	M 10 x 1	14	8	12	5
VHM 90-12 ED	PN 400	M 12 x 1.5	17	12	17	6
VHM 90-14 ED	PN 400	M 14 x 1.5	19	12	17	6
VHM 90-16 ED	PN 400	M 16 x 1.5	22	12	17	8
VHM 90-18 ED	PN 400	M 18 x 1.5	24	12	17	8
VHM 90-20 ED	PN 400	M 20 x 1.5	26	14	19	10
VHM 90-22 ED	PN 400	M 22 x 1.5	27	14	19	10
VHM 90-24ED	PN 400	M 24 x 1.5	29.9	14	19	12
VHM 90-26 ED	PN 400	M 26 x 1.5	32	16	21	12
VHM 90-27 ED	PN 400	M 27 x 2	32	16	21	12
VHM 90-33 ED	PN 400	M 33 x 2	40	16	22.5	17
VHM 90-42 ED	PN 315	M 42 x 2	50	16	22.5	22
VHM 90-48 ED	PN 315	M 48 x 2	55	16	22.5	24

G=接口螺纹

内六角螺堵

连接1: 公制外螺纹
密封形式: F型

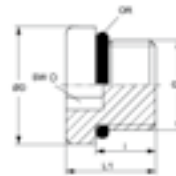

VHMO 90



订货号	工作压力 bar	G1	ØD mm	i mm	L1 mm	SW mm	OR
VHMO 90-08	PN 630	M 8 x 1	12	9.5	13.0	4	6.1 x 1.6
VHMO 90-10	PN 630	M 10 x 1	13	9.5	13.5	5	8.1 x 1.6
VHMO 90-12	PN 630	M 12 x 1.5	17	11.0	16.0	6	9.3 x 2.2
VHMO 90-14	PN 630	M 14 x 1.5	19	11.0	16.0	6	11.3 x 2.2
VHMO 90-16	PN 630	M 16 x 1.5	21	12.5	17.5	8	13.3 x 2.2
VHMO 90-18	PN 630	M 18 x 1.5	23	14.0	19.0	8	15.3 x 2.2
VHMO 90-20	PN 630	M 20 x 1.5	26	14.0	19.0	10	17.3 x 2.2
VHMO 90-22	PN 630	M 22 x 1.5	27	15.0	20.0	10	19.3 x 2.2
VHMO 90-27	PN 400	M 27 x 2	32	18.5	23.5	12	23.6 x 2.9
VHMO 90-33	PN 400	M 33 x 2	38	18.5	25.0	14	29.6 x 2.9
VHMO 90-42	PN 400	M 42 x 2	48	19.0	25.5	22	38.6 x 2.9
VHMO 90-48	PN 400	M 48 x 2	55	21.5	28.0	24	44.6 x 2.9

G1=接口螺纹

单向阀(管对管连接)

连接1: 公制外螺纹
密封形式: 24°内锥面密封
连接2: 公制外螺纹
密封形式: 24°内锥面密封
标准: DIN 3865

开启压力: 1bar, 同时也可选用开启压力为0.2bar; 0.5bar; 2; 3; 5bar的弹簧更换。

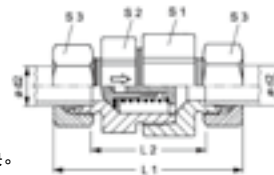

XRD



订货号	起动压力	系列	工作压力 bar	Ød2 mm	G1	L1 mm	L2 mm	S1	S2
XRD NW 04 HL	约1巴	L	PN 250	6	M 12 x 1.5	58.0	29.0	17	17
XRD NW 06 HL	约1巴	L	PN 250	8	M 14 x 1.5	59.0	30.0	19	19
XRD NW 08 HL	约1巴	L	PN 250	10	M 16 x 1.5	69.5	40.5	24	22
XRD NW 10 HL	约1巴	L	PN 250	12	M 18 x 1.5	72.5	43.5	30	27
XRD NW 13 HL	约1巴	L	PN 250	15	M 22 x 1.5	77.5	47.5	32	27
XRD NW 16 HL	约1巴	L	PN 160	18	M 26 x 1.5	83.5	51.5	36	36
XRD NW 20 HL	约1巴	L	PN 160	22	M 30 x 2	93.5	61.5	46	41
XRD NW 25 HL	约1巴	L	PN 100	28	M 36 x 2	102.5	69.5	55	50
XRD NW 32 HL	约1巴	L	PN 100	35	M 45 x 2	117.5	74.5	60	60
XRD NW 40 HL	约1巴	L	PN 100	42	M 52 x 2	119.0	74.0	70	65
XRD NW 03 HS	约1巴	S	PN 400	6	M 14 x 1.5	63.5	34.5	19	17
XRD NW 04 HS	约1巴	S	PN 400	8	M 16 x 1.5	63.5	34.5	19	17
XRD NW 06 HS	约1巴	S	PN 400	10	M 18 x 1.5	72.5	40.5	24	22
XRD NW 08 HS	约1巴	S	PN 400	12	M 20 x 1.5	74.5	42.5	27	24
XRD NW 10 HS	约1巴	S	PN 315	14	M 22 x 1.5	82.5	47.5	32	27
XRD NW 13 HS	约1巴	S	PN 315	16	M 24 x 1.5	86.5	50.5	36	32
XRD NW 16 HS	约1巴	S	PN 250	20	M 30 x 2	97.5	54.5	41	38
XRD NW 20 HS	约1巴	S	PN 250	25	M 36 x 2	106.5	58.5	50	46
XRD NW 25 HS	约1巴	S	PN 250	30	M 42 x 2	122.5	69.5	60	55
XRD NW 32 HS	约1巴	S	PN 250	38	M 52 x 2	136.5	75.5	70	65

系列: LL=特轻系列 L=轻系列 S=重系列; G1=接口螺纹

单向阀(油口到管路)

XHVR-ED

连接1: BSP标准外螺纹

密封形式: E型

连接2: 公制外螺纹

密封形式: 24°内锥面密封

开启压力: 1bar, 同时也可选用开启压力为0.2bar, 0.5bar, 2, 3, 5bar的弹簧更换

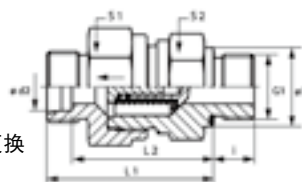

订货号	起动压力	系列	工作压力 bar	Ød2 mm	G1	ØD mm	i mm	L1 mm	L2 mm	S1	S2
XHVR NW 04 HL ED	约1巴	L	PN 250	6	G 1/8" -28	14	8	35.0	28.0	17	17
XHVR NW 06 HL ED	约1巴	L	PN 250	8	G 1/4" -19	19	12	37.0	30.0	19	19
XHVR NW 08 HL ED	约1巴	L	PN 250	10	G 1/4" -19	19	12	45.5	38.5	22	24
XHVR NW 10 HL ED	约1巴	L	PN 250	12	G 3/8" -19	22	12	49.5	42.5	30	27
XHVR NW 13 HL ED	约1巴	L	PN 250	15	G 1/2" -14	27	14	52.5	45.5	32	27
XHVR NW 16 HL ED	约1巴	L	PN 160	18	G 1/2" -14	27	14	57.5	50.0	36	36
XHVR NW 20 HL ED	约1巴	L	PN 160	22	G 3/4" -14	32	16	62.5	55.0	46	41
XHVR NW 25 HL ED	约1巴	L	PN 100	28	G 1" -11	40	18	70.5	63.0	55	50
XHVR NW 32 HL ED	约1巴	L	PN 100	35	G 1.1/4" -11	50	20	79.5	69.0	60	60
XHVR NW 40 HL ED	约1巴	L	PN 100	42	G 1.1/2" -11	55	22	79.5	68.5	70	65
XHVR NW 03 HS ED	约1巴	S	PN 400	6	G 1/4" -19	19	12	38.5	31.5	19	19
XHVR NW 04 HS ED	约1巴	S	PN 400	8	G 1/4" -19	19	12	38.5	31.5	19	19
XHVR NW 06 HS ED	约1巴	S	PN 400	10	G 3/8" -19	22	12	45.5	38.0	24	22
XHVR NW 08 HS ED	约1巴	S	PN 400	12	G 3/8" -19	22	12	48.5	41.0	27	24
XHVR NW 10 HS ED	约1巴	S	PN 315	14	G 1/2" -14	27	14	52.5	44.5	32	27
XHVR NW 13 HS ED	约1巴	S	PN 315	16	G 1/2" -14	27	14	56.5	48.0	36	32
XHVR NW 16 HS ED	约1巴	S	PN 250	20	G 3/4" -14	32	16	62.5	52.0	46	41
XHVR NW 20 HS ED	约1巴	S	PN 250	25	G 1" -11	40	18	66.5	54.5	50	46
XHVR NW 25 HS ED	约1巴	S	PN 250	30	G 1.1/4" -11	50	20	77.5	64.0	60	60
XHVR NW 32 HS ED	约1巴	S	PN 250	38	G 1.1/2" -11	55	22	85.5	69.5	70	65

系列: LL=特轻系列 L=轻系列 S=重系列; G1=接口螺纹

单向阀(油口到管路)

XHVM-ED

连接1: 公制圆柱管螺纹

密封形式: E型

连接2: 公制外螺纹

密封形式: 24°内锥面密封

开启压力: 1bar, 同时也可选用开启压力为0.2bar, 0.5bar, 2, 3, 5bar的弹簧更换

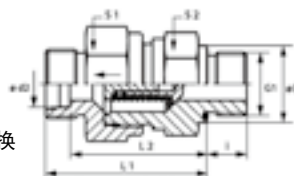

订货号	起动压力	系列	工作压力 bar	Ød2 mm	G1	ØD mm	i mm	L1 mm	L2 mm	S1	S2
XHVM NW 04 HL ED	约1巴	L	PN 250	6	M 10 x 1	14	8	35.0	28.0	17	17
XHVM NW 06 HL ED	约1巴	L	PN 250	8	M 12 x 1.5	17	12	36.0	29.0	19	19
XHVM NW 08 HL ED	约1巴	L	PN 250	10	M 14 x 1.5	19	12	45.5	38.5	24	22
XHVM NW 10 HL ED	约1巴	L	PN 250	12	M 16 x 1.5	22	12	49.5	42.5	30	27
XHVM NW 13 HL ED	约1巴	L	PN 250	15	M 18 x 1.5	24	12	52.5	45.5	32	27
XHVM NW 16 HL ED	约1巴	L	PN 160	18	M 22 x 1.5	27	14	57.5	50.0	36	36
XHVM NW 20 HL ED	约1巴	L	PN 160	22	M 26 x 1.5	32	16	62.5	55.0	46	41
XHVM NW 25 HL ED	约1巴	L	PN 100	28	M 33 x 2	40	18	70.5	63.0	55	50
XHVM NW 32 HL ED	约1巴	L	PN 100	35	M 42 x 2	50	20	79.5	69.0	60	60
XHVM NW 40 HL ED	约1巴	L	PN 100	42	M 48 x 2	55	22	79.5	68.5	70	65
XHVM NW 03 HS ED	约1巴	S	PN 400	6	M 12 x 1.5	17	12	38.5	31.5	19	19
XHVM NW 04 HS ED	约1巴	S	PN 400	8	M 14 x 1.5	19	12	38.5	31.5	19	19
XHVM NW 06 HS ED	约1巴	S	PN 400	10	M 16 x 1.5	22	12	45.5	38.0	24	22
XHVM NW 08 HS ED	约1巴	S	PN 400	12	M 18 x 1.5	24	12	48.5	41.0	27	24
XHVM NW 10 HS ED	约1巴	S	PN 315	14	M 20 x 1.5	26	14	52.5	44.5	32	27
XHVM NW 13 HS ED	约1巴	S	PN 315	16	M 22 x 1.5	27	14	56.5	48.0	36	32
XHVM NW 16 HS ED	约1巴	S	PN 250	20	M 27 x 2	32	16	62.5	52.0	46	41
XHVM NW 20 HS ED	约1巴	S	PN 250	25	M 33 x 2	40	18	66.5	54.5	50	46
XHVM NW 25 HS ED	约1巴	S	PN 250	30	M 42 x 2	50	20	77.5	64.0	60	60
XHVM NW 32 HS ED	约1巴	S	PN 250	38	M 48 x 2	55	22	85.5	69.5	70	65

系列: LL=特轻系列 L=轻系列 S=重系列; G1=接口螺纹

单向阀(管路到油口)

XHZR-ED

结构形式: 直通

连接1: BSP标准外螺纹

密封形式: E型

连接2: 公制外螺纹

密封形式: 24° 内锥面密封

开启压力: 1bar, 同时也可选用开启压力为0.2bar, 0.5bar, 2, 3, 5bar的弹簧更换

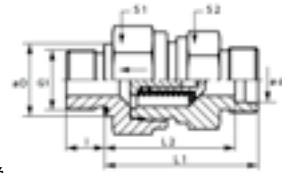

订货号	起动压力	系列	工作压力 bar	Ød2 mm	G1	ØD mm	i mm	L1 mm	L2 mm	S1	S2
XHZR NW 04 HL ED	约1巴	L	PN 250	6	G 1/8" -28	14	8	33.5	26.5	17	17
XHZR NW 06 HL ED	约1巴	L	PN 250	8	G 1/4" -19	19	12	33.5	28.5	19	19
XHZR NW 08 HL ED	约1巴	L	PN 250	10	G 1/4" -19	19	12	45.5	38.5	24	22
XHZR NW 10 HL ED	约1巴	L	PN 250	12	G 3/8" -19	22	12	47.5	40.5	30	27
XHZR NW 13 HL ED	约1巴	L	PN 250	15	G 1/2" -14	27	14	49.5	42.5	32	27
XHZR NW 16 HL ED	约1巴	L	PN 160	18	G 1/2" -14	27	14	55.5	48.0	36	36
XHZR NW 20 HL ED	约1巴	L	PN 160	22	G 3/4" -14	32	16	63.5	56.0	46	41
XHZR NW 25 HL ED	约1巴	L	PN 100	28	G 1" -11	40	18	71.5	64.0	55	50
XHZR NW 32 HL ED	约1巴	L	PN 100	35	G 1.1/4" -11	50	20	80.5	70.0	60	60
XHZR NW 40 HL ED	约1巴	L	PN 100	42	G 1.1/2" -11	55	22	81.5	70.5	70	65
XHZR NW 03 HS ED	约1巴	S	PN 400	6	G 1/4" -19	19	12	38.5	31.5	19	19
XHZR NW 04 HS ED	约1巴	S	PN 400	8	G 1/4" -19	19	12	38.5	31.5	19	19
XHZR NW 06 HS ED	约1巴	S	PN 400	10	G 3/8" -19	22	12	45.5	38.0	24	22
XHZR NW 08 HS ED	约1巴	S	PN 400	12	G 3/8" -19	22	12	48.5	41.0	27	24
XHZR NW 10 HS ED	约1巴	S	PN 315	14	G 1/2" -14	27	14	51.5	43.5	32	27
XHZR NW 13 HS ED	约1巴	S	PN 315	16	G 1/2" -14	27	14	54.5	46.0	36	32
XHZR NW 16 HS ED	约1巴	S	PN 250	20	G 3/4" -14	32	16	60.5	50.0	46	41
XHZR NW 20 HS ED	约1巴	S	PN 250	25	G 1" -11	40	18	66.5	54.5	50	46
XHZR NW 25 HS ED	约1巴	S	PN 250	30	G 1.1/4" -11	50	20	77.5	64.0	60	60
XHZR NW 32 HS ED	约1巴	S	PN 250	38	G 1.1/2" -11	55	22	87.5	71.5	70	65

系列: LL=特轻系列 L=轻系列 S=重系列; G1=接口螺纹

单向阀(管路到油口)

XHZM-ED

结构形式: 直通

连接1: 公制圆柱管螺纹

密封形式: E型

连接2: 公制外螺纹

密封形式: 24°内锥面密封

开启压力: 1bar, 同时也可选用开启压力为0.2bar, 0.5bar, 2, 3, 5bar的弹簧更换

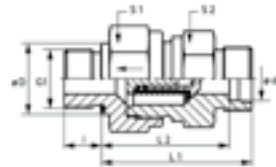

订货号	起动压力	系列	工作压力 bar	Ød2 mm	G1	ØD mm	i mm	L1 mm	L2 mm	S1	S2
XHZM NW 04 HL ED	约1巴	L	PN 250	6	M 10 x 1	14	8	33.5	26.5	17	17
XHZM NW 06 HL ED	约1巴	L	PN 250	8	M 12 x 1.5	-	12	33.5	28.5	19	19
XHZM NW 08 HL ED	约1巴	L	PN 250	10	M 14 x 1.5	-	12	45.5	38.5	24	22
XHZM NW 10 HL ED	约1巴	L	PN 250	12	M 16 x 1.5	-	12	47.5	40.5	30	27
XHZM NW 13 HL ED	约1巴	L	PN 250	15	M 18 x 1.5	-	12	49.5	42.5	32	27
XHZM NW 16 HL ED	约1巴	L	PN 160	18	M 22 x 1.5	-	14	55.5	48.0	36	36
XHZM NW 20 HL ED	约1巴	L	PN 160	22	M 26 x 1.5	-	16	63.5	56.0	46	41
XHZM NW 25 HL ED	约1巴	L	PN 100	28	M 33 x 2	-	18	71.5	64.0	55	50
XHZM NW 32 HL ED	约1巴	L	PN 100	35	M 42 x 2	-	20	80.5	70.0	60	60
XHZM NW 40 HL ED	约1巴	L	PN 100	42	M 48 x 2	-	22	81.5	70.5	70	65
XHZM NW 03 HS ED	约1巴	S	PN 400	6	M 12 x 1.5	-	12	38.5	31.5	19	19
XHZM NW 04 HS ED	约1巴	S	PN 400	8	M 14 x 1.5	-	12	38.5	31.5	19	19
XHZM NW 06 HS ED	约1巴	S	PN 400	10	M 16 x 1.5	-	12	45.5	38.0	24	22
XHZM NW 08 HS ED	约1巴	S	PN 400	12	M 18 x 1.5	-	12	48.5	41.0	27	24
XHZM NW 10 HS ED	约1巴	S	PN 315	14	M 20 x 1.5	-	14	51.5	43.5	32	27
XHZM NW 13 HS ED	约1巴	S	PN 315	16	M 22 x 1.5	-	14	54.5	46.0	36	32
XHZM NW 16 HS ED	约1巴	S	PN 250	20	M 27 x 2	--	16	60.5	50.0	46	41
XHZM NW 20 HS ED	约1巴	S	PN 250	25	M 33 x 2	-	18	66.5	54.5	50	46
XHZM NW 25 HS ED	约1巴	S	PN 250	30	M 42 x 2	-	20	77.5	64.0	60	60
XHZM NW 32 HS ED	约1巴	S	PN 250	38	M 48 x 2	-	22	87.5	71.5	70	65

系列: LL=特轻系列 L=轻系列 S=重系列; G1=接口螺纹

旋转管接头



HANSA-FLEX公司供应的旋转管接头有滑动轴承和滚珠轴承两种。

工作压力

- ① 滑动轴承 - 最大压力至64bar (L系列) 或160bar (S系列)
- ② 滚珠轴承 - 一般最大压力可至250bar

工作温度

NBR密封: -35℃ ~ +100℃

FKM密封: -25℃ ~ +120℃

储存条件

旋转管接头可以在仓库中储存6个月。如果符合DIN7716标准规定的仓库储存条件, 则球轴承旋转管接头的储存期可达到1年。

装配须知

球轴承旋转管接头的使用寿命, 除了受到工作条件的影响外, 还取决于是否能够保证无应力的管道连接。为此, 应该避免直接和管子的连接。对于软管的连接长度, 我们在此建议, 连接长度大约为软管外径的5倍。这样的连接长度有利于对振动和冲击压力的吸收。为了连接软管, 我们建议使用符合DIN3865标准要求的带旋转螺母的管接头。

允许转速值 (滑动轴承)

管径 (L系列)	6	8	10	12	15	18	22	28	35	
允许转速 (转/分钟)	28	28	21	17	13	10	10	7	7	
管径 (S系列)	6	8	10	12	14	16	20	25	30	38
允许转速 (转/分钟)	11	11	9	7	5	5	4	4	3	3

转速和启动力矩表 (滚珠轴承)

Φ外径	工作压力下允许的转速 (转/分钟)					启动力矩 250bar/Nm
	25bar	64bar	100bar	160bar	250bar	
6-8	1500	750	400	200	85	0.08
10-18	800	400	200	100	45	0.24
20-28	300	150	75	38	15	0.8
30-38	200	100	50	25	10	2.0

旋转接头(滚珠轴承)

DG

接口 1: 公制外螺纹, 圆柱形, 24°内锥

接口 2: 公制外螺纹, 圆柱形, 24°内锥

结构类型: 滚珠轴承

结构形式: 直通

供货范围: 本体(不带锁紧螺母和卡套)

材质: 钢

表面保护: 镀锌

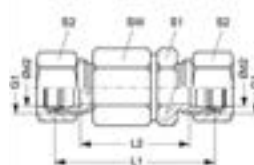

订货号	系列	工作压力 bar	Ød2 mm	G1	管外径Ø mm	L1 mm	L2 mm	SW mm	S1	S2
DG NW 03 HS	S	PN 250	6	M 14 x 1.5	6	61	47	22	17	17
DG NW 04 HS	S	PN 250	8	M 16 x 1.5	8	61	47	22	17	19
DG NW 08 HS	S	PN 250	12	M 20 x 1.5	12	72	57	30	24	24
DG NW 13 HS	S	PN 250	16	M 24 x 1.5	16	74	57	30	27	30
DG NW 16 HS	S	PN 250	20	M 30 x 2	20	92	71	41	36	36
DG NW 20 HS	S	PN 250	25	M 36 x 2	25	96	72	41	41	46
DG NW 25 HS	S	PN 250	30	M 42 x 2	30	109	82	60	46	50
DG NW 32 HS	S	PN 250	38	M 52 x 2	38	114	82	60	55	60

系列: LL=特轻系列 L=轻系列 S=重系列; G1=接口螺纹

旋转接头(滚珠轴承)

DG H

接口 1: 公制外螺纹, 圆柱形, 24°内锥

接口 2: 公制外螺纹, 圆柱形, 24°内锥

结构类型: 滚珠轴承

结构形式: 直通

供货范围: 本体(不带锁紧螺母和卡套)

材质: 钢

表面保护: 镀锌

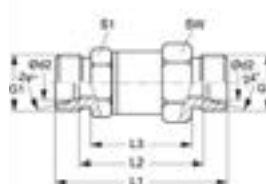

订货号	系列	工作压力 bar	Ød2 mm	G1	管外径Ø mm	L1 mm	L2 mm	L3 mm	SW mm	S1
DG NW 04 HL	L	PN 315	6	M 12 x 1.5	6	57.0	43.0	37.0	22	19
DG NW 06 HL	L	PN 315	8	M 14 x 1.5	8	57.0	43.0	37.0	22	19
DG NW 08 HL	L	PN 315	10	M 16 x 1.5	10	68.0	54.0	46.0	30	24
DG NW 10 HL	L	PN 315	12	M 18 x 1.5	12	68.0	54.0	46.0	30	24
DG NW 13 HL	L	PN 315	15	M 22 x 1.5	15	70.0	56.0	46.0	30	24
DG NW 16 HL	L	PN 315	18	M 26 x 1.5	18	80.5	65.5	56.5	41	36
DG NW 20 HL	L	PN 160	22	M 30 x 2	22	84.5	69.5	56.5	41	36
DG NW 25 HL	L	PN 160	28	M 36 x 2	28	96.5	81.5	68.5	60	55
DG NW 32 HL	L	PN 160	35	M 45 x 2	35	100.5	79.5	68.5	60	55
DG NW 03 HS H	S	PN 500	6	M 14 x 1.5	6	61.0	47.0	37.0	22	19
DG NW 04 HS H	S	PN 500	8	M 16 x 1.5	8	61.0	47.0	37.0	22	19
DG NW 06 HS H	S	PN 500	10	M 18 x 1.5	10	61.0	55.0	37.0	30	24
DG NW 08 HS H	S	PN 500	12	M 20 x 1.5	12	72.0	57.0	48.0	30	24
DG NW 10 HS H	S	PN 500	14	M 22 x 1.5	14	73.0	57.0	45.0	30	24
DG NW 13 HS H	S	PN 400	16	M 24 x 1.5	16	74.0	57.0	46.0	30	24
DG NW 16 HS H	S	PN 400	20	M 30 x 2	20	92.0	71.0	60.0	41	36
DG NW 20 HS H	S	PN 400	25	M 36 x 2	25	98.0	72.0	62.0	41	36
DG NW 25 HS H	S	PN 400	30	M 42 x 2	30	109.0	82.0	69.0	60	55
DG NW 32 HS H	S	PN 315	38	M 52 x 2	38	114.0	82.0	70.0	60	55

系列: LL=特轻系列 L=轻系列 S=重系列; G1=接口螺纹

旋转接头(W90°滚珠轴承)

接口 1: 公制外螺纹, 圆柱形, 24°内锥
 接口 2: 公制外螺纹, 圆柱形, 24°内锥
 结构形式: 双角90°, 滚珠轴承
 供货范围: 本体(不带锁紧螺母和卡套)
 材质: 钢
 表面保护: 镀锌

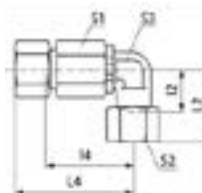

DG 90



订货号	系列	工作压力 bar	Ød2 mm	管外径Ø mm	L2 mm	l2 mm	L4 mm	l4 mm	S1	S2	S3
DG 90 NW 03 HS	S	PN 250	6	6	31	16.0	59.0	44.5	22	17	17
DG 90 NW 04 HS	S	PN 250	8	8	32	17.0	59.0	44.5	22	19	17
DG 90 NW 08 HS	S	PN 250	12	12	38	21.5	72.0	55.5	30	24	22
DG 90 NW 13 HS	S	PN 250	16	16	43	24.5	73.0	54.5	30	30	22
DG 90 NW 16 HS	S	PN 250	20	20	48	26.5	94.5	72.5	41	36	36
DG 90 NW 20 HS	S	PN 250	25	25	54	30.0	95.5	71.0	41	46	36
DG 90 NW 25 HS	S	PN 250	30	30	62	35.5	116.0	89.0	60	50	50
DG 90 NW 32 HS	S	PN 250	38	38	72	41.0	117.0	86.5	60	60	50

系列: LL=特轻系列 L=轻系列 S=重系列

旋转接头(2x 90°滚珠轴承)

接口 1: 公制外螺纹, 圆柱形, 24°内锥
 接口 2: 公制外螺纹, 圆柱形, 24°内锥
 结构形式: 双角90°, 滚珠轴承
 供货范围: 本体(不带锁紧螺母和卡套)
 材质: 钢
 表面保护: 镀锌

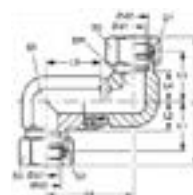

DG D



订货号	系列	工作压力 bar	Ød1 mm	Ød2 mm	G1	管外径Ø mm	L1 mm	L2 mm	L3 mm	L4 mm	L5 mm	L6 mm	L7 mm	SW mm	S1	S3
DG D NW 08 HS	S	PN 250	9.5	12	M 20 x 1.5	12	29.0	21.5	34.0	26.5	39.5	53.0	81.0	24	22	24
DG D NW 13 HS	S	PN 250	9.5	16	M 24 x 1.5	16	33.0	24.5	34.0	25.5	39.5	53.0	87.0	24	22	30
DG D NW 16 HS	S	PN 250	16.0	20	M 30 x 2	20	37.0	26.5	50.0	39.5	56.5	76.0	109.0	32	36	36
DG D NW 20 HS	S	PN 250	16.0	25	M 36 x 2	25	42.0	30.0	50.0	38.0	56.5	76.0	116.0	32	36	46
DG D NW 25 HS	S	PN 250	26.0	30	M 42 x 2	30	49.0	35.5	58.0	44.5	65.0	92.5	133.0	50	50	50
DG D NW 32 HS	S	PN 250	26.0	38	M 52 x 2	38	57.0	41.0	58.0	42.0	65.0	92.5	145.0	50	50	60

系列: LL=特轻系列 L=轻系列 S=重系列; G1=接口螺纹

旋转接头(滚珠轴承)

接口 1: BSP外螺纹.圆柱形.E型
 接口 2: 公制外螺纹.圆柱形.24°内锥
 结构类型: 滚珠轴承
 结构形式: 直通
 供货范围: 本体(不带锁紧螺母和卡套)
 材质: 钢
 表面保护: 镀锌

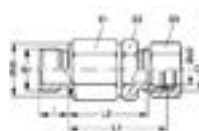

DGR



订货号	系列	工作压力 bar	Ød2 mm	G1 mm	管外径Ø mm	G2 mm	i mm	Ød3 mm	L1 mm	L2 mm	S1	S2	S3
DGR NW 03 HS	S	PN 250	6	G 1/4" -19	6	M 14 x 1.5	12	19	49	42.0	22	17	17
DGR NW 04 HS	S	PN 250	8	G 1/4" -19	8	M 16 x 1.5	12	19	49	42.0	22	17	19
DGR NW 08 HS	S	PN 250	12	G 3/8" -19	12	M 20 x 1.5	12	22	60	52.5	30	24	24
DGR NW 13 HS	S	PN 250	16	G 1/2" -14	16	M 24 x 1.5	14	27	60	54.5	30	27	30
DGR NW 16 HS	S	PN 250	20	G 3/4" -14	20	M 30 x 2	16	32	76	65.5	41	36	36
DGR NW 20 HS	S	PN 250	25	G 1" -11	25	M 36 x 2	18	40	78	66.0	41	41	46
DGR NW 25 HS	S	PN 250	30	G 1.1/4" -11	30	M 42 x 2	20	50	89	75.5	60	46	50
DGR NW 32 HS	S	PN 250	38	G 1.1/2" -11	38	M 52 x 2	22	55	92	76.0	60	55	60

系列: LL=特轻系列 L=轻系列 S=重系列; G1=接口螺纹 G2=接口螺纹

旋转接头(滚珠轴承)

DGR H

接口 1: BSP外螺纹,圆柱形,E型

接口 2: 公制外螺纹,圆柱形,24°内锥

结构类型: 滚珠轴承

结构形式: 直通

供货范围: 本体(不带锁紧螺母和卡套)

材质: 钢

表面保护: 镀锌

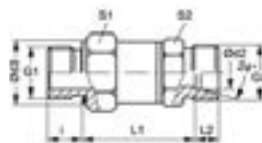

订货号	系列	工作压力 bar	Ød mm	G1	管外径Ø mm	G2	d3 mm	i mm	L1 mm	L2 mm	S1	S2
DGR NW 04 HL	L	PN 315	6	G 1/8" -28	6	M 12 x 1.5	14	8	40.5	7.0	22	19
DGR NW 04 HL 1/4	L	PN 315	6	G 1/4" -19	6	M 12 x 1.5	19	12	40.0	7.0	22	19
DGR NW 06 HL	L	PN 315	8	G 1/4" -19	8	M 14 x 1.5	19	12	40.0	7.0	22	19
DGR NW 08 HL	L	PN 315	10	G 1/4" -19	10	M 16 x 1.5	19	12	41.0	7.0	22	19
DGR NW 08 HL 3/8	L	PN 315	10	G 3/8" -19	10	M 16 x 1.5	22	12	50.0	7.0	30	24
DGR NW 10 HL 1/2	L	PN 315	12	G 1/2" -14	12	M 18 x 1.5	27	14	50.0	7.0	30	24
DGR NW 13 HL	L	PN 315	15	G 1/2" -14	15	M 22 x 1.5	27	14	51.0	7.0	30	24
DGR NW 13 HL 3/4	L	-	15	G 3/4" -14	15	M 22 x 1.5	-	-	-	-	-	-
DGR NW 16 HL	L	PN 315	18	G 1/2" -14	18	M 26 x 1.5	27	14	51.5	7.5	30	30
DGR NW 16 HL 3/4	L	-	18	G 3/4" -14	18	M 26 x 1.5	-	-	-	-	-	-
DGR NW 20 HL 1/2	L	-	22	G 1/2" -14	22	M 30 x 2	-	-	-	-	-	-
DGR NW 20 HL	L	PN 160	22	G 3/4" -14	22	M 30 x 2	32	16	66.0	7.5	41	36
DGR NW 20 HL 1	L	-	22	G 1" -11	22	M 30 x 2	-	-	-	-	-	-
DGR NW 03 HS H	S	PN 500	6	G 1/4" -19	6	M 14 x 1.5	19	12	42.0	7.0	22	19
DGR NW 04 HS H	S	PN 500	8	G 1/4" -19	8	M 16 x 1.5	19	12	42.0	7.0	22	19
DGR NW 06 HS H	S	PN 500	10	G 3/8" -19	10	M 18 x 1.5	22	12	42.0	7.5	22	19
DGR NW 08 HS H	S	PN 500	12	G 3/8" -19	12	M 20 x 1.5	22	12	52.5	7.5	30	24
DGR NW 08 HS 1/2 H	S	PN 500	12	G 1/2" -14	12	M 20 x 1.5	27	12	53.0	7.5	22	32
DGR NW 10 HS H	S	PN 500	14	G 1/2" -14	14	M 22 x 1.5	27	14	52.0	8.0	30	24
DGR NW 13 HS H	S	PN 400	16	G 1/2" -14	16	M 24 x 1.5	27	14	51.5	8.5	30	24
DGR NW 16 HS H	S	PN 400	20	G 3/4" -14	20	M 30 x 2	32	16	65.5	10.5	41	36
DGR NW 16 HS 1 H	S	PN 400	20	G 1" -11	20	M 30 x 2	40	18	65.0	10.5	41	36
DGR NW 20 HS 3/4 H	S	PN 400	25	G 3/4" -14	25	M 36 x 2	32	16	65.0	12.0	41	36
DGR NW 20 HS H	S	PN 400	25	G 1" -11	25	M 36 x 2	40	18	66.0	12.0	41	36

系列: LL=特轻系列 L=轻系列 S=重系列; G1=接口螺纹 G2=接口螺纹

旋转接头(W90°滚珠轴承)

DGR 90

接口 1: BSP外螺纹,圆柱形,E型

接口 2: 米制外螺纹,圆柱形,24°内锥

结构类型: 滚珠轴承

结构形式: 角度90°

供货范围: 本体(不带锁紧螺母和卡套)

材质: 钢

表面保护: 镀锌

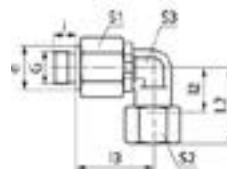

订货号	系列	工作压力 bar	管外径Ø mm	G mm	Ød mm	i mm	L2 mm	l2 mm	l3 mm	S1	S2	S3
DGR 90 NW 03 HS	S	PN 250	6	G 1/4" -19	19	12	31	16.0	39.5	22	17	17
DGR 90 NW 04 HS	S	PN 250	8	G 1/4" -19	19	12	32	17.0	39.5	22	19	17
DGR 90 NW 08 HS	S	PN 250	12	G 3/8" -19	22	12	38	21.5	51.0	30	24	22
DGR 90 NW 13 HS	S	PN 250	16	G 1/2" -14	27	14	43	24.5	49.0	30	30	22
DGR 90 NW 16 HS	S	PN 250	20	G 3/4" -14	32	16	48	26.5	67.0	41	36	36
DGR 90 NW 20 HS	S	PN 250	25	G 1" -11	40	18	54	30.0	65.0	41	46	36
DGR 90 NW 25 HS	S	PN 250	30	G 1.1/4" -11	50	20	62	35.5	82.5	60	50	50
DGR 90 NW 32 HS	S	PN 250	38	G 1.1/2" -11	55	22	72	41.0	80.5	60	60	50

系列: LL=特轻系列 L=轻系列 S=重系列; G=接口螺纹

旋转接头(滚珠轴承)

DGM

接口 1: 公制外螺纹.圆柱形.E型

接口 2: 公制外螺纹.圆柱形.24°内锥

结构类型: 滚珠轴承

结构形式: 直通

供货范围: 本体(不带锁紧螺母和卡套)

材质: 钢

表面保护: 镀锌

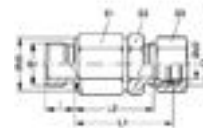

订货号	系列	工作压力 bar	Ød2 mm	G1 mm	管外径Ø mm	G2 mm	i mm	Ød3 mm	L1 mm	L2 mm	S1	S2	S3
DGM NW 03 HS 14	S	PN 250	6	M 14 x 1.5	6	M 14 x 1.5	12	19	49	42.0	22	17	17
DGM NW 04 HS	S	PN 250	8	M 14 x 1.5	8	M 16 x 1.5	12	19	49	42.0	22	17	19
DGM NW 08 HS	S	PN 250	12	M 18 x 1.5	12	M 20 x 1.5	12	24	60	52.5	30	24	24
DGM NW 13 HS	S	PN 250	16	M 22 x 1.5	16	M 24 x 1.5	14	27	60	51.5	30	27	30
DGM NW 16 HS	S	PN 250	20	M 27 x 2	20	M 30 x 2	16	32	76	65.5	41	36	36
DGM NW 20 HS	S	PN 250	25	M 33 x 2	25	M 36 x 2	18	40	78	66.0	41	41	46
DGM NW 25 HS	S	PN 250	30	M 42 x 2	30	M 42 x 2	20	50	89	75.5	60	46	50
DGM NW 32 HS	S	PN 250	38	M 48 x 2	38	M 52 x 2	22	55	92	76.0	60	55	60

系列: LL=特轻系列 L=轻系列 S=重系列; G1=接口螺纹 G2=接口螺纹

旋转螺栓连接(滚珠轴承)

DGM H

接口 1: 公制外螺纹.圆柱形.E型

接口 2: 公制外螺纹.圆柱形.24°内锥

结构类型: 滚珠轴承

结构形式: 直通

供货范围: 本体(不带锁紧螺母和卡套)

材质: 钢

表面保护: 镀锌

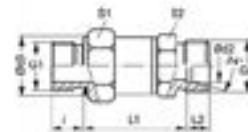

订货号	系列	工作压力 bar	Ød2 mm	G1 mm	管外径Ø mm	G2 mm	i mm	Ød3 mm	L1 mm	L2 mm	S1	S2
DGM NW 04 HL	L	PN 315	6	M 10 x 1	6	M 12 x 1.5	8	14	40.5	7.0	22	19
DGM NW 04 HL 12	L	PN 315	6	M 12 x 1.5	6	M 12 x 1.5	12	17	40.5	7.0	22	19
DGM NW 06 HL	L	PN 315	8	M 12 x 1.5	8	M 14 x 1.5	12	17	40.5	7.0	22	19
DGM NW 06 HL 14	L	PN 315	8	M 14 x 1.5	8	M 14 x 1.5	12	19	40.0	7.0	22	19
DGM NW 08 HL	L	PN 315	10	M 14 x 1.5	10	M 16 x 1.5	12	19	40.0	7.0	22	19
DGM NW 08 HL 16	L	PN 315	10	M 16 x 1.5	10	M 16 x 1.5	12	22	50.0	7.0	30	24
DGM NW 10 HL 18	L	PN 315	12	M 18 x 1.5	12	M 18 x 1.5	14	27	50.0	7.0	30	24
DGM NW 10 HL 22	L	PN 315	12	M 22 x 1.5	12	M 18 x 1.5	14	27	*1	7.0	30	24
DGM NW 13 HL	L	PN 315	15	M 18 x 1.5	15	M 22 x 1.5	14	24	51.0	7.0	30	24
DGM NW 13 HL 22	L	PN 315	15	M 22 x 1.5	15	M 22 x 1.5	14	27	51.0	7.0	30	24
DGM NW 16 HL	L	PN 315	18	M 22 x 1.5	18	M 26 x 1.5	14	27	50.5	7.5	30	30
DGM NW 20 HL	L	PN 160	22	M 26 x 1.5	22	M 30 x 2	16	32	64.5	7.5	41	36
DGM NW 03 HS 12 H	S	PN 500	6	M 12 x 1.5	6	M 14 x 1.5	12	17	42.5	7.0	22	19
DGM NW 06 HS 18 H	S	PN 500	10	M 18 x 1.5	10	M 18 x 1.5	12	22	42.0	7.5	22	19
DGM NW 06 HS H	S	PN 500	10	M 16 x 1.5	10	M 18 x 1.5	12	22	42.0	7.5	22	19
DGM NW 20 HS 27 H	S	PN 400	25	M 27 x 2	25	M 36 x 2	18	40	66.0	12.0	41	36

系列: LL=特轻系列 L=轻系列 S=重系列; G1=接口螺纹 G2=接口螺纹

旋转接头(W90°滚珠轴承)

接口 1: 公制外螺纹.圆柱形.E型

接口 2: 公制外螺纹.圆柱形.24°内锥

结构类型: 滚珠轴承

结构形式: 角度90°

供货范围: 本体(不带锁紧螺母和卡套)

材质: 钢

表面保护: 镀锌

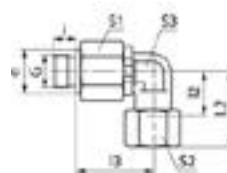

DGM 90



订货号	系列	工作压力 bar	管外径Ø mm	G mm	Ød mm	i mm	L2 mm	l2 mm	l3 mm	S1	S2	S3
DGM 90 NW 03 HS 14	S	PN 250	6	M 14 x 1.5	19	12	31	16.0	39.5	22	17	17
DGM 90 NW 04 HS	S	PN 250	8	M 14 x 1.5	19	12	32	17.0	39.5	22	19	17
DGM 90 NW 08 HS	S	PN 250	12	M 18 x 1.5	22	12	38	21.5	51.0	30	24	22
DGM 90 NW 13 HS	S	PN 250	16	M 22 x 1.5	27	14	43	24.5	49.0	30	30	22
DGM 90 NW 16 HS	S	PN 250	20	M 27 x 2	32	16	48	26.5	67.0	41	36	36
DGM 90 NW 20 HS	S	PN 250	25	M 33 x 2	40	18	54	30.0	65.0	41	46	36
DGM 90 NW 25 HS	S	PN 250	30	M 42 x 2	50	20	62	35.5	82.5	60	50	50
DGM 90 NW 32 HS	S	PN 250	38	M 48 x 2	55	22	72	41.0	80.5	60	60	50

系列: LL=特轻系列 L=轻系列 S=重系列; G=接口螺纹

隔板式旋转接头(滚珠轴承)

接口 1: 公制外螺纹, 圆柱形, 24°内锥

接口 2: 公制外螺纹, 圆柱形, 24°内锥

结构类型: 滚珠轴承

结构形式: 直通

供货范围: 本体(不带锁紧螺母和卡套)

材质: 钢

表面保护: 镀锌

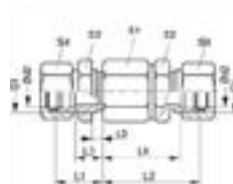

DGS



订货号	系列	工作压力 bar	Ød2 mm	G1	管外径Ø mm	L1 mm	L2 mm	L3 mm	L4 mm	L5 mm	S1	S2	S3	S4
DGS NW 03 HS	S	PN 250	6	M 14 x 1.5	6	23	49	16.0	42.0	5.0	22	17	19	17
DGS NW 04 HS	S	PN 250	8	M 16 x 1.5	8	23	49	16.0	42.0	5.0	22	17	22	19
DGS NW 08 HS	S	PN 250	12	M 20 x 1.5	12	23	60	15.5	52.5	5.0	30	24	27	24
DGS NW 13 HS	S	PN 250	16	M 24 x 1.5	16	26	60	17.5	51.5	5.0	30	27	32	30
DGS NW 16 HS	S	PN 250	20	M 30 x 2	20	39	76	28.5	65.5	15.0	41	36	41	36
DGS NW 20 HS	S	PN 250	25	M 36 x 2	25	42	78	30.0	66.0	15.0	41	41	46	46
DGS NW 25 HS	S	PN 250	30	M 42 x 2	30	44	89	30.5	75.5	15.0	60	46	50	50
DGS NW 32 HS	S	PN 250	38	M 52 x 2	38	47	92	31.0	76.0	15.0	60	55	65	60

系列: LL=特轻系列 L=轻系列 S=重系列; G1=接口螺纹

隔板式旋转接头(滚珠轴承)

接口 1: 公制外螺纹, 圆柱形, 24°内锥
 接口 2: 公制外螺纹, 圆柱形, 24°内锥
 结构类型: 滚珠轴承
 结构形式: 直通
 供货范围: 本体(不带锁紧螺母和卡套)
 材质: 钢
 表面保护: 镀锌

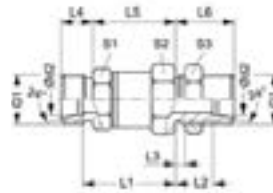

DGS H



订货号	系列	工作压力 bar	Ød2 mm	G1	管外径Ø mm	L1 mm	L2 mm	L3 mm	L4 mm	L5 mm	L6 mm	S1	S2	S3
DGS NW 06 HL	L	PN 315	8	M 14 x 1.5	8	40.0	16.0	5	10	37.0	23.0	19	22	17
DGS NW 08 HL	L	PN 315	10	M 16 x 1.5	10	50.0	16.0	5	11	46.0	23.0	24	30	22
DGS NW 10 HL	L	PN 315	12	M 18 x 1.5	12	50.0	16.0	5	11	46.0	23.0	24	30	24
DGS NW 13 HL	L	PN 315	15	M 22 x 1.5	15	51.0	19.0	5	12	46.0	26.0	24	30	30
DGS NW 16 HL	L	PN 315	18	M 26 x 1.5	18	61.0	28.0	15	12	56.5	35.5	36	41	36
DGS NW 20 HL	L	PN 160	22	M 30 x 2	22	63.0	30.5	15	14	56.5	38.0	36	41	41
DGS NW 25 HL	L	PN 160	28	M 36 x 2	28	75.0	31.0	15	14	68.5	38.5	55	60	46
DGS NW 32 HL	L	PN 160	35	M 45 x 2	35	74.0	31.5	15	16	68.5	42.0	55	60	55
DGS NW 04 HS H	S	PN 500	8	M 16 x 1.5	8	42.0	16.0	5	12	37.0	23.0	19	22	22
DGS NW 08 HS H	S	PN 500	12	M 20 x 1.5	12	52.5	15.5	5	12	48.0	23.0	24	30	27
DGS NW 13 HS H	S	PN 400	16	M 24 x 1.5	16	51.5	17.5	5	14	46.0	26.0	24	30	32
DGS NW 16 HS H	S	PN 400	20	M 30 x 2	20	65.5	28.5	15	16	60.0	39.0	36	41	41
DGS NW 20 HS H	S	PN 400	25	M 36 x 2	25	66.0	30.0	15	18	60.0	42.0	36	41	46
DGS NW 25 HS H	S	PN 400	30	M 42 x 2	30	75.5	30.5	15	22	69.0	44.0	55	60	50

系列: LL=特轻系列 L=轻系列 S=重系列; G1=接口螺纹

隔板式旋转接头(滚珠轴承)

接口 1: 公制外螺纹.圆柱形.E型
 接口 2: 公制外螺纹.圆柱形.24°内锥
 结构类型: 滚珠轴承
 结构形式: 直通
 供货范围: 本体(不带锁紧螺母和卡套)
 材质: 钢
 表面保护: 镀锌

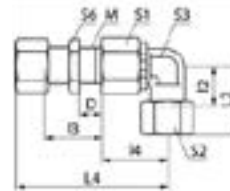

DGS 90



订货号	系列	工作压力 bar	管外径Ø mm	M mm	D mm	L2 mm	I2 mm	L3 mm	L4 mm	I4 mm	S1	S3	S6
DGS 90 NW03 HS	S	PN 250	6	M 14 x 1.5	5	31	16.0	16.0	70.0	39.5	22	17	19
DGS 90 NW04 HS	S	PN 250	8	M 16 x 1.5	5	32	17.0	16.0	70.0	39.5	22	17	22
DGS 90 NW08 HS	S	PN 250	12	M 20 x 1.5	5	38	21.5	15.5	83.0	51.0	30	22	27
DGS 90 NW13 HS	S	PN 250	16	M 24 x 1.5	5	43	24.5	17.5	85.0	49.0	30	22	32
DGS 90 NW16 HS	S	PN 250	20	M 30 x 2	15	48	26.5	28.5	117.5	67.0	41	36	41
DGS 90 NW20 HS	S	PN 250	25	M 36 x 2	15	54	30.0	30.0	119.5	65.0	41	36	46
DGS 90 NW25 HS	S	PN 250	30	M 42 x 2	15	62	35.5	30.5	140.0	82.5	60	50	50
DGS 90 NW32 HS	S	PN 250	38	M 52 x 2	15	72	41.0	31.0	142.0	80.5	60	50	65

系列: LL=特轻系列 L=轻系列 S=重系列

旋转接头(滑动轴承)

接口 1: BSP外螺纹.圆柱形.E型

接口 2: 公制外螺纹.圆柱形.24°内锥

结构类型: 滑动轴承

结构形式: 直通

供货范围: 本体(不带锁紧螺母和卡套)

材质: 钢

表面保护: 镀锌

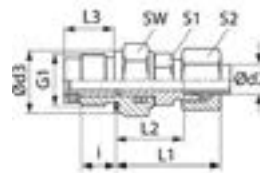

GVR

订货号	系列	工作压力 bar	Ød2 mm	G1	管外径Ø mm	i mm	Ød3 mm	L1 mm	L2 mm	L3 mm	SW mm	S1	S2
GVR NW 04 HL 1/4	L	PN 40	6	G 1/4" -19	6	12	19	40	21.0	18.0	19	12	14
GVR NW 06 HL	L	PN 40	8	G 1/4" -19	8	12	19	40	21.0	18.0	19	14	17
GVR NW 08 HL 3/8	L	PN 40	10	G 3/8" -19	10	12	22	40	25.0	18.0	24	17	19
GVR NW 10 HL 1/2	L	PN 40	12	G 1/2" -14	12	14	27	42	27.0	21.0	27	19	22
GVR NW 13 HL 3/4	L	PN 40	15	G 3/4" -14	15	16	32	47	32.0	24.0	32	24	27
GVR NW 16 HL 1	L	PN 40	18	G 1" -11	18	18	40	51	35.0	27.5	41	27	22
GVR NW 20 HL 1	L	PN 40	22	G 1" -11	22	18	40	55	39.5	27.5	41	32	36
GVR NW 25 HL 11/4	L	PN 40	28	G 1.1/4" -11	28	20	40	57	40.5	31.0	50	41	41
GVR NW 32 HL 11/2	L	PN 40	35	G 1.1/2" -11	35	22	55	66	44.5	35.0	55	46	50
GVR NW 03 HS	S	PN 100	6	G 1/4" -19	6	12	19	38	23.0	18.0	19	14	17
GVR NW 04 HS	S	PN 100	8	G 1/4" -19	8	12	19	39	24.0	18.0	19	17	19
GVR NW 06 HS	S	PN 100	10	G 3/8" -19	10	12	22	43	26.5	18.0	24	19	22
GVR NW 08 HS 1/2	S	PN 100	12	G 1/2" -14	12	14	27	45	28.5	21.0	27	22	24
GVR NW 13 HS 3/4	S	PN 100	16	G 3/4" -14	16	16	32	52	33.5	24.0	32	27	30
GVR NW 16 HS 1	S	PN 100	20	G 1" -11	20	18	40	60	38.0	27.5	41	32	36
GVR NW 20 HS	S	PN 100	25	G 1" -11	25	18	40	65	40.5	27.5	41	41	46
GVR NW 25 HS 11/4	S	PN 100	30	G 1.1/4" -11	30	20	50	68	41.5	31.0	50	46	50
GVR NW 32 HS 11/2	S	PN 100	38	G 1.1/2" -11	38	22	55	78	47.0	35.0	55	55	60

系列: LL=特轻系列 L=轻系列 S=重系列; G1=接口螺纹

旋转接头(滑动轴承)

接口 1: 公制外螺纹.圆柱形.E型

接口 2: 公制外螺纹.圆柱形.24°内锥

结构类型: 滑动轴承

结构形式: 直通

供货范围: 本体(不带锁紧螺母和卡套)

材质: 钢

表面保护: 镀锌

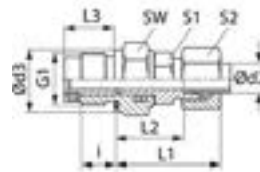

GVM

订货号	系列	工作压力 bar	Ød2 mm	G1	管外径Ø mm	i mm	Ød3 mm	L1 mm	L2 mm	L3 mm	SW mm	S1	S2
GVM NW 04 HL 14	L	PN 40	6	M 14 x 1.5	6	12	19	27	20.0	18.0	19	12	14
GVM NW 06 HL 14	L	PN 40	8	M 14 x 1.5	8	12	19	29	21.0	18.0	19	12	17
GVM NW 08 HL 18	L	PN 40	10	M 18 x 1.5	10	12	24	30	26.0	18.0	24	14	19
GVM NW 10 HL 22	L	PN 40	12	M 22 x 1.5	12	14	27	32	27.0	21.0	27	17	22
GVM NW 13 HL 27	L	PN 40	15	M 27 x 2	15	16	32	36	33.0	24.0	32	19	27
GVM NW 16 HL 33	L	PN 40	18	M 33 x 2	18	18	40	40	37.5	27.5	41	27	32
GVM NW 20 HL 33	L	PN 40	22	M 33 x 2	22	18	40	44	39.5	27.5	41	27	36
GVM NW 25 HL 42	L	PN 40	28	M 42 x 2	28	20	50	47	44.0	31.0	50	36	41
GVM NW 32 HL 48	L	PN 40	35	M 48 x 2	35	22	55	56	54.0	35.0	55	41	50
GVM NW 03 HS 14	S	PN 100	6	M 14 x 1.5	6	12	19	31	21.0	18.0	19	12	17
GVM NW 04 HS	S	PN 100	8	M 14 x 1.5	8	12	19	32	22.0	18.0	19	14	19
GVM NW 06 HS 18	S	PN 100	10	M 18 x 1.5	10	12	24	34	27.0	18.0	24	17	22
GVM NW 08 HS	S	PN 100	12	M 22 x 1.5	12	14	27	38	28.0	21.0	27	17	24
GVM NW 13 HS 27	S	PN 100	16	M 27 x 2	16	16	32	43	34.0	24.0	32	24	30
GVM NW 16 HS 33	S	PN 100	20	M 33 x 2	20	18	40	48	39.5	27.5	41	27	36
GVM NW 20 HS	S	PN 100	25	M 33 x 2	25	18	40	54	42.5	27.5	41	36	46
GVM NW 25 HS	S	PN 100	30	M 42 x 2	30	20	50	62	48.0	31.0	50	41	50
GVM NW 32 HS	S	PN 100	38	M 48 x 2	38	22	55	72	55.0	35.0	55	50	60

系列: LL=特轻系列 L=轻系列 S=重系列; G1=接口螺纹

旋转接头(2x90°滑动轴承)

接口 1: 公制外螺纹, 圆柱形, 24°内锥
 接口 2: 公制外螺纹, 圆柱形, 24°内锥
 结构类型: 滑动轴承
 结构形式: 角度90°
 供货范围: 本体(不带锁紧螺母和卡套)
 材质: 钢
 表面保护: 镀锌

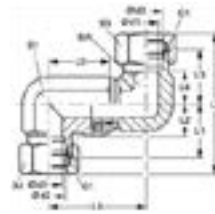

DG D H



订货号	系列	工作压力 bar	Ød2 mm	G1	管外径Ø mm	L1 mm	L2 mm	L3 mm	L4 mm	L6 mm	SW mm
DG D NW 08 HS H	S	PN 400	12	M 20 x 1.5	12	28	20.5	28	20.5	32	32
DG D NW 13 HS H	S	PN 400	16	M 24 x 1.5	16	34	25.5	34	25.5	40	40
DG D NW 16 HS H	S	PN 250	20	M 30 x 2	20	38	27.5	38	27.5	45	45
DG D NW 20 HS H	S	PN 250	25	M 36 x 2	25	45	33.0	45	33.0	55	55
DG D NW 25 HS H	S	PN 250	30	M 42 x 2	30	52	38.5	52	38.5	65	65
DG D NW 32 HS H	S	PN 250	38	M 52 x 2	38	59	43.0	59	43.0	75	75

系列: LL=特轻系列 L=轻系列 S=重系列; G1=接口螺纹

旋转接头(W90°滑动轴承)

接口 1: 公制外螺纹, 圆柱形, 24°内锥
 接口 2: 公制外螺纹, 圆柱形, 24°内锥
 结构类型: 滑动轴承
 结构形式: 角度90°
 供货范围: 本体(不带锁紧螺母和卡套)
 材质: 钢
 表面保护: 镀锌

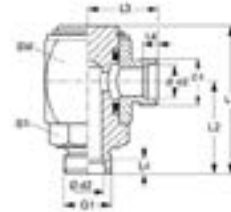

GV 90 H



订货号	系列	工作压力 bar	Ød2 mm	G1	管外径Ø mm	L1 mm	L2 mm	L3 mm	L4 mm	SW mm	S1
GV 90 NW 04 HL H	L	PN 250	6	M 12 x 1.5	6	49	31	23	7.0	27	19
GV 90 NW 06 HL H	L	PN 250	8	M 14 x 1.5	8	54	33	25	7.0	30	22
GV 90 NW 08 HL H	L	PN 250	10	M 16 x 1.5	10	57	36	27	7.0	32	24
GV 90 NW 10 HL H	L	PN 250	12	M 18 x 1.5	12	63	39	29	7.0	36	27
GV 90 NW 13 HL H	L	PN 250	15	M 22 x 1.5	15	68	42	32	7.0	40	32
GV 90 NW 16 HL H	L	PN 160	18	M 26 x 1.5	18	75	46	34	7.5	45	36
GV 90 NW 20 HL H	L	PN 160	22	M 30 x 2	22	89	54	41	7.5	55	41
GV 90 NW 25 HL H	L	PN 100	28	M 36 x 2	28	103	62	46	7.5	65	50
GV 90 NW 32 HL H	L	PN 100	35	M 45 x 2	35	115	69	53	10.5	75	55
GV 90 NW 40 HL H	L	PN 100	42	M 52 x 2	42	147	90	61	11.0	90	70
GV 90 NW 03 HS H	S	PN 400	6	M 14 x 1.5	6	51	33	25	7.0	27	19
GV 90 NW 04 HS H	S	PN 400	8	M 16 x 1.5	8	51	33	25	7.0	27	19
GV 90 NW 06 HS H	S	PN 400	10	M 18 x 1.5	10	56	35	27	7.5	30	22
GV 90 NW 08 HS H	S	PN 400	12	M 20 x 1.5	12	58	37	28	7.5	32	24
GV 90 NW 10 HS H	S	PN 400	14	M 22 x 1.5	14	66	42	32	8.0	36	27
GV 90 NW 13 HS H	S	PN 400	16	M 24 x 1.5	16	70	44	34	8.5	40	32
GV 90 NW 16 HS H	S	PN 250	20	M 30 x 2	20	79	50	38	10.5	45	36
GV 90 NW 20 HS H	S	PN 250	25	M 36 x 2	25	93	58	45	12.0	55	41
GV 90 NW 25 HS H	S	PN 250	30	M 42 x 2	30	109	68	52	13.5	65	50
GV 90 NW 32 HS H	S	PN 250	38	M 52 x 2	38	121	75	59	16.0	75	55

系列: LL=特轻系列 L=轻系列 S=重系列; G1=接口螺纹

旋转接头(W90°滑动轴承)

接口 1: BSP外螺纹,圆柱形,E型

接口 2: 公制外螺纹, 圆柱形, 24°内锥

结构类型: 滑动轴承

结构形式: 角度90°

供货范围: 本体(不带锁紧螺母和卡套)

材质: 钢

表面保护: 镀锌



GVR 90



订货号	系列	工作压力 bar	Ød2 mm	G1	管外径Ø mm	d3 mm	i mm	L1 mm	L2 mm	L4 mm	L5 mm	SW mm	S1	S2
GVR 90 NW 04 HL 1/4	L	PN 40	6	G 1/4" -19	6	19	12	20.0	18.0	27	12.0	12	19	14
GVR 90 NW 06 HL	L	PN 40	8	G 1/4" -19	8	19	12	21.0	18.0	29	14.0	12	19	17
GVR 90 NW 08 HL 3/8	L	PN 40	10	G 3/8" -19	10	22	12	26.0	18.0	30	15.0	14	24	19
GVR 90 NW 10 HL 1/2	L	PN 40	12	G 1/2" -14	12	27	14	27.0	21.0	32	17.0	17	27	22
GVR 90 NW 13 HL 3/4	L	PN 40	15	G 3/4" -14	15	32	16	33.0	24.0	36	21.0	19	32	27
GVR 90 NW 16 HL 1	L	PN 40	18	G 1" -11	18	40	18	37.5	27.5	40	23.5	27	41	32
GVR 90 NW 20 HL 1	L	PN 40	22	G 1" -11	22	40	18	39.5	27.5	44	27.5	27	41	36
GVR 90 NW 25 HL 1 1/4	L	PN 40	28	G 1.1/4" -11	28	50	20	44.0	31.0	47	30.5	36	50	41
GVR 90 NW 32 HL 1 1/2	L	PN 40	35	G 1.1/2" -11	35	55	22	54.0	35.0	56	34.5	41	55	50
GVR 90 NW 03 HS	S	PN 100	6	G 1/4" -19	6	19	12	21.0	18.0	31	16.0	12	19	17
GVR 90 NW 04 HS	S	PN 100	8	G 1/4" -19	8	19	12	22.0	18.0	32	17.0	14	19	19
GVR 90 NW 06 HS	S	PN 100	10	G 3/8" -19	10	22	12	27.0	18.0	34	17.5	17	24	22
GVR 90 NW 08 HS 1/2	S	PN 100	12	G 1/2" -14	12	27	14	28.0	21.0	38	21.5	17	27	24
GVR 90 NW 13 HS 3/4	S	PN 100	16	G 3/4" -14	16	32	16	34.0	24.0	43	24.5	24	32	30
GVR 90 NW 16 HS 1	S	PN 100	20	G 1" -11	20	40	18	39.5	27.5	48	26.5	27	41	36
GVR 90 NW 20 HS	S	PN 100	25	G 1" -11	25	40	18	42.5	27.5	54	30.0	36	41	46
GVR 90 NW 25 HS	S	PN 100	30	G 1.1/4" -11	30	50	20	48.0	31.0	62	35.5	41	50	50
GVR 90 NW 32 HS	S	PN 100	38	G 1.1/2" -11	38	55	22	55.0	35.0	72	41.0	50	55	60

系列: LL=特轻系列 L=轻系列 S=重系列; G1=接口螺纹

旋转接头(W90°滑动轴承)

接口 1: BSP外螺纹,圆柱形,E型

接口 2: 公制外螺纹, 圆柱形, 24°内锥

结构类型: 滑动轴承

结构形式: 角度90°

供货范围: 本体(不带锁紧螺母和卡套)

材质: 钢

表面保护: 镀锌

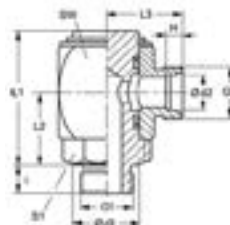

GVR 90 H



订货号	系列	工作压力 bar	Ød2 mm	G1	管外径Ø mm	G2	d3 mm	i mm	H mm	L1 mm	L2 mm	L3 mm	SW mm	S1
GVR 90 NW 04 HL H	L	PN 250	6	G 1/8" -28	6	M 12 x 1.5	14	8	7.0	40	21	23	27	17
GVR 90 NW 04 HL 1/4 H	L	PN 250	6	G 1/4" -19	6	M 12 x 1.5	19	12	7.0	41	22	23	27	19
GVR 90 NW 06 HL H	L	PN 250	8	G 1/4" -19	8	M 14 x 1.5	19	12	7.0	46	25	25	30	22
GVR 90 NW 08 HL H	L	PN 250	10	G 1/4" -19	10	M 16 x 1.5	19	12	7.0	46	25	26	30	22
GVR 90 NW 08 HL 3/8 H	L	PN 250	10	G 3/8" -19	10	M 16 x 1.5	22	12	7.0	48	27	27	32	24
GVR 90 NW 10 HL H	L	PN 250	12	G 3/8" -19	12	M 18 x 1.5	22	12	7.0	48	27	27	32	24
GVR 90 NW 10 HL 1/2 H	L	PN 250	12	G 1/2" -14	12	M 18 x 1.5	27	14	7.0	55	30	29	36	27
GVR 90 NW 13 HL H	L	PN 250	15	G 1/2" -14	15	M 22 x 1.5	27	14	7.0	59	33	32	40	32
GVR 90 NW 16 HL H	L	PN 160	18	G 1/2" -14	18	M 26 x 1.5	27	14	7.5	59	33	32	40	32
GVR 90 NW 16 HL 3/4 H	L	PN 160	18	G 3/4" -14	18	M 26 x 1.5	32	16	7.5	66	35	32	45	32
GVR 90 NW 20 HL H	L	PN 160	22	G 3/4" -14	22	M 30 x 2	32	16	7.5	66	35	36	45	36
GVR 90 NW 20 HL 1 H	L	PN 160	22	G 1" -11	22	M 30 x 2	40	18	7.5	78	41	36	55	36
GVR 90 NW 25 HL H	L	PN 100	28	G 1" -11	28	M 36 x 2	40	18	7.5	78	41	41	55	41
GVR 90 NW 32 HL 1 1/4 H	L	PN 100	35	G 1.1/4" -11	35	M 45 x 2	50	20	10.5	92	51	48	65	50
GVR 90 NW 40 HL H	L	PN 100	42	G 1.1/2" -11	42	M 52 x 2	55	22	11.0	102	56	53	75	55
GVR 90 NW 03 HS H	S	PN 400	6	G 1/4" -19	6	M 14 x 1.5	19	12	7.0	41	22	25	27	19
GVR 90 NW 04 HS H	S	PN 400	8	G 1/4" -19	8	M 16 x 1.5	19	12	7.0	41	22	25	27	19
GVR 90 NW 06 HS H	S	PN 400	10	G 3/8" -19	10	M 18 x 1.5	22	12	7.5	46	25	27	30	22
GVR 90 NW 06 HS 1/4 H	S	PN 400	10	G 1/4" -19	10	M 18 x 1.5	19	12	7.5	41	22	27	27	22

旋转接头(W90°滑动轴承)

接口 1: BSP外螺纹.圆柱形.E型

接口 2: 公制外螺纹, 圆柱形, 24°内锥

结构类型: 滑动轴承

结构形式: 角度90°

供货范围: 本体(不带锁紧螺母和卡套)

材质: 钢

表面保护: 镀锌

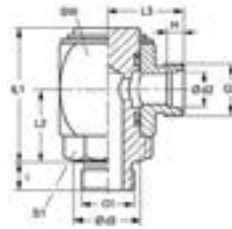

GVR 90 H



订货号	系列	工作压力 bar	Ød2 mm	G1	管外径Ø mm	G2	d3 mm	i mm	H mm	L1 mm	L2 mm	L3 mm	SW mm	S1
GVR 90 NW 08 HS H	S	PN 400	12	G 3/8" -19	12	M 20 x 1.5	22	12	7.5	48	27	28	32	24
GVR 90 NW 08 HS 1/2 H	S	PN 400	12	G 1/2" -14	12	M 20 x 1.5	27	14	7.5	55	30	27	36	24
GVR 90 NW 10 HS H	S	PN 400	14	G 1/2" -14	14	M 22 x 1.5	27	14	8.0	55	30	32	36	27
GVR 90 NW 13 HS H	S	PN 400	16	G 1/2" -14	16	M 24 x 1.5	27	14	8.5	59	33	34	40	32
GVR 90 NW 16 HS H	S	PN 250	20	G 3/4" -14	20	M 30 x 2	32	16	10.5	66	35	38	45	36
GVR 90 NW 20 HS 3/4 H	S	PN 250	25	G 3/4" -14	25	M 36 x 2	32	16	12.0	66	35	45	55	41
GVR 90 NW 20 HS H	S	PN 250	25	G 1" -11	25	M 36 x 2	40	18	12.0	78	41	45	55	41
GVR 90 NW 25 HS H	S	PN 250	30	G 1.1/4" -11	30	M 42 x 2	50	20	13.5	92	51	52	65	50
GVR 90 NW 32 HS H	S	PN 250	38	G 1.1/2" -11	38	M 52 x 2	55	22	16.0	102	56	59	75	55

系列: LL=特轻系列 L=轻系列 S=重系列; G1=接口螺纹 G2=接口螺纹

旋转接头(W90°滑动轴承)

接口 1: 公制外螺纹.圆柱形.E型

接口 2: 公制外螺纹.圆柱形.24°内锥

密封形式: E型

结构类型: 滑动轴承

结构形式: 角度90°

供货范围: 本体(不带锁紧螺母和卡套)

材质: 钢

表面保护: 镀锌

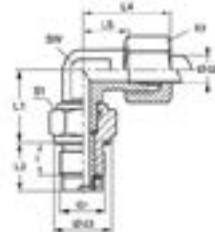

GVM 90



订货号	系列	工作压力 bar	Ød2 mm	G1	管外径Ø mm	d3 mm	i mm	L1 mm	L2 mm	L4 mm	L5 mm	SW mm	S1	S2
GVM 90 NW 04 HL 14	L	PN 40	6	M 14 x 1.5	6	19	12	20.0	18.0	27	12.0	12	19	14
GVM 90 NW 08 HL 18	L	PN 40	10	M 18 x 1.5	10	24	12	26.0	18.0	30	15.0	14	24	19
GVM 90 NW 10 HL 22	L	PN 40	12	M 22 x 1.5	12	27	14	27.0	21.0	32	17.0	17	27	22
GVM 90 NW 13 HL 27	L	PN 40	15	M 27 x 2	15	32	16	33.0	24.0	36	21.0	19	32	27
GVM 90 NW 16 HL 33	L	PN 40	18	M 33 x 2	18	40	18	37.5	27.5	40	23.5	27	41	32
GVM 90 NW 20 HL 33	L	PN 40	22	M 33 x 2	22	40	18	39.5	27.5	44	27.5	27	41	36
GVM 90 NW 25 HL 42	L	PN 40	28	M 42 x 2	28	50	20	44.0	31.0	47	30.5	36	50	41
GVM 90 NW 32 HL 48	L	PN 40	35	M 48 x 2	35	55	22	54.0	35.0	56	34.5	41	55	50
GVM 90 NW 03 HS 14	S	PN 100	6	M 14 x 1.5	6	19	12	21.0	18.0	31	16.0	12	19	17
GVM 90 NW 06 HS 18	S	PN 100	10	M 18 x 1.5	10	24	12	27.0	18.0	34	17.5	17	24	22
GVM 90 NW 08 HS	S	PN 100	12	M 18 x 1.5	12	27	14	28.0	21.0	38	21.5	17	27	24
GVM 90 NW 08 HS 22	S	PN 100	12	M 22 x 1.5	12	27	14	28.0	32.0	38	21.5	17	27	24
GVM 90 NW 13 HS 27	S	PN 100	16	M 27 x 2	16	32	16	34.0	24.0	43	24.5	24	32	30
GVM 90 NW 16 HS 33	S	PN 100	20	M 33 x 2	20	40	18	39.5	27.5	48	26.5	27	41	36
GVM 90 NW 20 HS	S	PN 100	25	M 33 x 2	25	40	18	42.5	27.5	54	30.0	36	41	46
GVM 90 NW 25 HS	S	PN 100	30	M 42 x 2	30	50	20	48.0	31.0	62	35.5	41	50	50
GVM 90 NW 32 HS	S	PN 100	38	M 48 x 2	38	55	22	55.0	35.0	72	41.0	50	55	60

系列: LL=特轻系列 L=轻系列 S=重系列; G1=接口螺纹

旋转接头(W90°滑动轴承)

接口 1: 公制外螺纹,圆柱形,E型

接口 2: 公制外螺纹, 圆柱形, 24°内锥

密封形式: E型

结构类型: 滑动轴承

结构形式: 角度90°

供货范围: 本体(不带锁紧螺母和卡套)

材质: 钢

表面保护: 镀锌

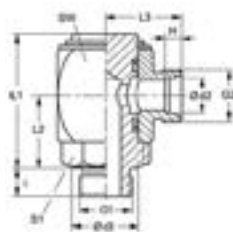

GVM 90 H



订货号	系列	工作压力 bar	Ød2 mm	G1	管外径Ø mm	G2	d3 mm	i mm	H mm	L1 mm	L2 mm	L3 mm	SW mm	S1
GVM 90 NW 04 HL H	L	PN 250	6	M 10 x 1	6	M 12 x 1.5	14	8	7.0	40	21	23	27	17
GVM 90 NW 04 HL 12 H	L	PN 250	6	M 12 x 1.5	6	M 12 x 1.5	14	12	7.0	41	22	23	27	17
GVM 90 NW 06 HL H	L	PN 250	8	M 12 x 1.5	8	M 14 x 1.5	17	12	7.0	41	22	23	27	19
GVM 90 NW 08 HL H	L	PN 250	10	M 14 x 1.5	10	M 16 x 1.5	19	12	7.0	46	25	26	30	22
GVM 90 NW 08 HL 16 H	L	PN 250	10	M 16 x 1.5	10	M 16 x 1.5	22	12	7.0	48	27	27	32	24
GVM 90 NW 10 HL H	L	PN 250	12	M 16 x 1.5	12	M 18 x 1.5	22	12	7.0	48	27	27	32	24
GVM 90 NW 10 HL 18 H	L	PN 250	12	M 18 x 1.5	12	M 18 x 1.5	24	12	7.0	55	30	29	36	27
GVM 90 NW 13 HL H	L	PN 250	15	M 18 x 1.5	15	M 22 x 1.5	24	12	7.0	55	30	30	36	27
GVM 90 NW 13 HL 22 H	L	PN 250	15	M 22 x 1.5	15	M 22 x 1.5	27	14	7.0	59	33	32	40	32
GVM 90 NW 16 HL H	L	PN 160	18	M 22 x 1.5	18	M 26 x 1.5	27	14	7.5	59	33	32	40	32
GVM 90 NW 20 HL H	L	PN 160	22	M 26 x 1.5	22	M 30 x 2	32	16	7.5	66	35	36	45	36
GVM 90 NW 25 HL H	L	PN 100	28	M 33 x 2	28	M 36 x 2	40	18	7.5	78	41	41	55	41
GVM 90 NW 32 HL H	L	PN 100	35	M 42 x 2	35	M 45 x 2	50	20	10.5	92	50	48	65	50
GVM 90 NW 40 HL H	L	PN 100	42	M 48 x 2	42	M 52 x 2	55	22	11.0	102	56	53	75	55
GVM 90 NW 03 HS H	S	PN 400	6	M 12 x 1.5	6	M 14 x 1.5	17	12	7.0	41	22	25	27	19
GVM 90 NW 03 HS 14 H	S	PN 400	6	M 14 x 1.5	6	M 14 x 1.5	19	12	7.0	41	22	25	27	19
GVM 90 NW 04 HS H	S	PN 400	8	M 14 x 1.5	8	M 16 x 1.5	19	12	7.0	41	22	25	27	19
GVM 90 NW 06 HS 14 H	S	PN 400	10	M 14 x 1.5	10	M 18 x 1.5	19	12	7.5	46	25	27	30	22
GVM 90 NW 06 HS H	S	PN 400	10	M 16 x 1.5	10	M 18 x 1.5	22	12	7.5	46	25	27	30	22
GVM 90 NW 08 HS H	S	PN 400	12	M 18 x 1.5	12	M 20 x 1.5	24	12	7.5	48	27	28	32	24
GVM 90 NW 10 HS 18 H	S	PN 400	14	M 18 x 1.5	14	M 22 x 1.5	24	14	8.0	55	30	32	36	27
GVM 90 NW 10 HS H	S	PN 400	14	M 20 x 1.5	14	M 22 x 1.5	26	14	8.0	55	30	32	36	27
GVM 90 NW 13 HS H	S	PN 400	16	M 22 x 1.5	16	M 24 x 1.5	27	14	8.5	59	33	34	40	32
GVM 90 NW 16 HS H	S	PN 250	20	M 27 x 2	20	M 30 x 2	32	16	10.5	66	35	38	45	36
GVM 90 NW 25 HS H	S	PN 160	30	M 42 x 2	30	M 42 x 2	50	20	13.5	92	51	52	65	50
GVM 90 NW 32 HS H	S	PN 160	38	M 48 x 2	38	M 52 x 2	55	22	16.0	102	56	59	75	55

系列: LL=特轻系列 L=轻系列 S=重系列; G1=接口螺纹 G2=接口螺纹

密封圈

结构类型: 密封圈

标准: DIN 3869

材料: 丁腈橡胶

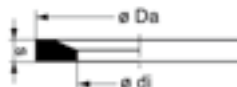

WD



订货号	用于螺纹	ØDa mm	Ødi mm	S
WD 8-1	M 8 x 1	9.9	6.5	1
WD 10-1 R 1/8	M 10 x 1	11.9	8.4	1
WD 12-1.5	M 12 x 1.5	14.4	9.8	1.5
WD 14-1.5 R 1/4	M 14 x 1.5	16.5	11.6	1.5
WD 16-1.5	M 16 x 1.5	18.9	13.8	1.5
WD R 3/8	-	18.9	14.7	1.5
WD 18-1.5	M 18 x 1.5	20.9	15.7	1.5
WD 20-1.5	M 20 x 1.5	22.9	17.8	1.5
WD R 1/2	-	23.9	18.5	1.5
WD 22-1.5	M 22 x 1.5	24.3	19.6	1.5
WD 26-27-R 3/4	M 26 x 1.5	29.2	23.9	1.5
WD 33-2 R 1	M 33 x 2	35.7	29.7	2
WD 42-2R1 1/4	M 42 x 2	45.8	38.8	2
WD 48-2 R 1 1/2	M 48 x 2	50.7	44.7	2
WD R 2	-	66	56	4

公制精密钢管

PR

标准: DIN EN 10305-4

材料特性值: K 235 (N/mm²)

材料: 钢 ST 37.4 NBK正火 (1.0255)

安全系数: S 1.5

表面处理: 磷化处理, 浸油

永久疲劳强度: $\hat{\sigma}_{Sch/D} 225$ (N/mm²)

描述:

公差: DIN 10305-4

模拟计算参照 DIN 2413 (draft)

备注: 下面所列的压力是针对直钢管

载荷 I: 静载荷

的。针对弯曲的钢管其壁厚根据标准

载荷 III: 压力强度范围 P = bar

DIN 2413 or DIN EN 13480-4计算

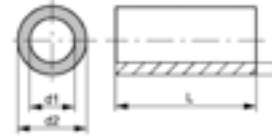

订货号	Ød2 mm	Ød1 mm	S mm	I 静载荷 bar	III 动载荷 bar
PR 04-0.5	4	3.0	0.50	210	189
PR 04-0.75	4	2.5	0.75	405	345
PR 05-0.75	5	3.5	0.75	325	282
PR 06-0.75	6	4.5	0.75	286	251
PR 04-1	4	2.0	1.00	603	484
PR 05-1	5	3.0	1.00	482	400
PR 06-1	6	4.0	1.00	416	352
PR 08-1	8	6.0	1.00	320	278
PR 10-1	10	8.0	1.00	263	232
PR 12-1	12	10.0	1.00	219	196
PR 14-1	14	12.0	1.00	187	169
PR 15-1	15	13.0	1.00	175	159
PR 16-1	16	14.0	1.00	164	149
PR 18-1	18	16.0	1.00	146	133
PR 22-1	22	20.0	1.00	119	109
PR 25-1	25	23.0	1.00	105	97
PR 06-1.5	6	3.0	1.50	663	524
PR 08-1.5	8	5.0	1.50	516	424
PR 10-1.5	10	7.0	1.50	407	345
PR 12-1.5	12	9.0	1.50	344	297
PR 14-1.5	14	11.0	1.50	299	262
PR 15-1.5	15	12.0	1.50	279	246
PR 16-1.5	16	13.0	1.50	262	231
PR 18-1.5	18	15.0	1.50	233	207
PR 20-1.5	20	17.0	1.50	209	188
PR 22-1.5	22	19.0	1.50	190	172
PR 25-1.5	25	22.0	1.50	167	152
PR 28-1.5	28	25.0	1.50	149	136
PR 32-1.5	32	29.0	1.50	131	120
PR 32-2.5	32	27.0	2.5	-	-
PR 06-2	6	2.0	2.00	924	683
PR 08-2	8	4.0	2.00	693	543
PR 10-2	10	6.0	2.00	554	451
PR 12-2	12	8.0	2.00	469	391
PR 14-2	14	10.0	2.00	407	345
PR 15-2	15	11.0	2.00	380	324
PR 16-2	16	12.0	2.00	346	298
PR 18-2	18	14.0	2.00	320	278
PR 20-2	20	16.0	2.00	288	252
PR 22-2	22	18.0	2.00	262	231
PR 25-2	25	21.0	2.00	230	205
PR 28-2	28	24.0	2.00	205	184
PR 30-2	30	26.0	2.00	192	173
PR 35-2	35	31.0	2.00	152	138
PR 42-2	42	38.0	2.00	119	109
PR 06-2.25	6	1.5	2.25	1053	755
PR 08-2.5	8	3.0	2.50	888	663
PR 10-2.5	10	5.0	2.50	711	555
PR 12-2.5	12	7.0	2.50	592	477
PR 14-2.5	14	9.0	2.50	514	423
PR 15-2.5	15	10.0	2.50	480	398
PR 16-2.5	16	11.0	2.50	450	377

订货号	Ød2 mm	Ød1 mm	S mm	I 静载荷 bar	III 动载荷 bar
PR 18-2.5	18	13.0	2.50	395	335
PR 20-2.5	20	15.0	2.50	355	305
PR 22-2.5	22	17.0	2.50	333	288
PR 25-2.5	25	20.0	2.50	293	256
PR 28-2.5	28	23.0	2.50	261	231
PR 30-2.5	30	25.0	2.50	244	217
PR 35-2.5	35	30.0	2.50	196	177
PR 38-2.5	38	33.0	2.50	181	163
PR 10-3	10	4.0	3.00	867	650
PR 12-3	12	6.0	3.00	723	562
PR 14-3	14	8.0	3.00	619	495
PR 15-3	15	9.0	3.00	578	467
PR 16-3	16	10.0	3.00	542	442
PR 18-3	18	12.0	3.00	482	400
PR 20-3	20	14.0	3.00	433	364
PR 22-3	22	16.0	3.00	394	335
PR 25-3	25	19.0	3.00	347	299
PR 28-3	28	22.0	3.00	309	270
PR 30-3	30	24.0	3.00	289	253
PR 35-3	35	29.0	3.00	241	214
PR 38-3	38	32.0	3.00	222	198
PR 42-3	42	36.0	3.00	193	174
PR 60-3	60	54.0	3.00	130	119
PR 14-3.5	14	7.0	3.50	731	568
PR 20-3.5	20	13.0	3.50	512	421
PR 25-3.5	25	18.0	3.50	409	347
PR 12-4	12	4.0	4.00	984	717
PR 16-4	16	8.0	4.00	738	572
PR 20-4	20	12.0	4.00	590	475
PR 25-4	25	17.0	4.00	472	393
PR 28-4	28	20.0	4.00	421	355
PR 30-4	30	22.0	4.00	393	334
PR 35-4	35	27.0	4.00	331	286
PR 38-4	38	30.0	4.00	305	266
PR 42-4	42	34.0	4.00	268	236
PR 50-4	50	42.0	4.00	225	201
PR 60-4	60	52.0	4.00	182	165
PR 25-4.5	25	16.0	4.50	535	437
PR 28-4.5	28	19.0	4.50	477	396
PR 25-5	25	15.0	5.00	597	480
PR 28-5	28	18.0	5.00	533	436
PR 30-5	30	20.0	5.00	489	411
PR 35-5	35	25.0	5.00	420	355
PR 38-5	38	28.0	5.00	387	330
PR 42-5	42	32.0	5.00	343	296
PR 50-5	50	40.0	5.00	288	252
PR 38-6	38	26.0	6.00	469	391
PR 50-6	50	38.0	6.00	350	302
PR 38-7	38	24.0	7.00	552	449
PR 65-8	65	49.0	8.00	356	306
PR 60-10	60	40.0	10.00	496	410
PR 80-10	80	60.0	10.00	346	312

公制精密钢管

PRVZ

标准: DIN EN 10305-4

材料: 钢 ST 37.4 NBK正火 (1.0255)

表面处理: 镀锌

描述:

模拟计算参照 DIN 2413 (draft)

负载 I: 静压力

负载 III: 压力强度范围 P = bar

材料特性值: K 235 (N/mm²)

安全系数: S 1.5

永久疲劳强度: $\dot{\sigma}_{Sch}/D$ 225 (N/mm²)

公差: DIN 10305-4

备注: 下面所列的压力是针对直钢管的。

针对弯曲的钢管其壁厚根据标准 DIN 2413 or DIN EN 13480-4计算

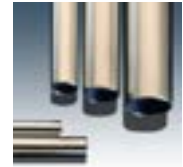
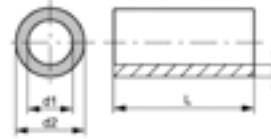

订货号	Ød2 mm	Ød1 mm	S mm	I 静载荷 bar	III 动载荷 bar
PR 05-0.75 VZ	5	2.5	0.75	325	282
PR 06-0.75 VZ	6	4.5	0.75	286	251
PR 04-1 VZ	4	2.0	1.00	602	484
PR 05-1 VZ	5	3.0	1.00	482	400
PR 06-1 VZ	6	4.0	1.00	416	352
PR 08-1 VZ	8	6.0	1.00	320	278
PR 10-1 VZ	10	8.0	1.00	263	232
PR 12-1 VZ	12	10.0	1.00	219	196
PR 15-1 VZ	15	13.0	1.00	175	159
PR 18-1 VZ	18	16.0	1.00	146	133
PR 06-1.5 VZ	6	3.0	1.50	663	524
PR 08-1.5 VZ	8	5.0	1.50	516	424
PR 10-1.5 VZ	10	7.0	1.50	407	345
PR 12-1.5 VZ	12	9.0	1.50	344	297
PR 14-1.5 VZ	14	11.0	1.50	299	262
PR 15-1.5 VZ	15	12.0	1.50	279	246
PR 16-1.5 VZ	16	13.0	1.50	262	231
PR 18-1.5 VZ	18	15.0	1.50	233	207
PR 20-1.5 VZ	20	17.0	1.50	209	188
PR 22-1.5 VZ	22	19.0	1.50	190	172
PR 25-1.5 VZ	25	22	1.5	-	-
PR 28-1.5 VZ	28	25.0	1.50	149	136
PR 35-1.5 VZ	35	32	1.5	-	-
PR 06-2 VZ	6	2.0	2.0	-	-
PR 08-2 VZ	8	4.0	2.00	693	543
PR 10-2 VZ	10	6.0	2.00	554	451
PR 12-2 VZ	12	8.0	2.00	469	391
PR 14-2 VZ	14	10.0	2.00	407	345
PR 15-2 VZ	15	11.0	2.00	380	324
PR 16-2 VZ	16	12.0	2.00	346	298
PR 18-2 VZ	18	14.0	2.00	320	278
PR 20-2 VZ	20	16.0	2.00	288	252

订货号	Ød2 mm	Ød1 mm	S mm	I 静载荷 bar	III 动载荷 bar
PR 22-2 VZ	22	18.0	2.00	262	231
PR 25-2 VZ	25	21.0	2.00	230	205
PR 28-2 VZ	28	24.0	2.00	205	184
PR 35-2 VZ	35	31.0	2.00	152	138
PR 38-2 VZ	38	34.0	2.00	-	-
PR 42-2 VZ	42	38.0	2.00	119	109
PR 10-2.5 VZ	10	5.0	2.50	711	555
PR 12-2.5 VZ	12	7.0	2.50	592	477
PR 14-2.5 VZ	14	9.0	2.50	514	423
PR 16-2.5 VZ	16	11.0	2.50	450	377
PR 18-2.5 VZ	18	13.0	2.50	395	335
PR 20-2.5 VZ	20	15.0	2.50	355	305
PR 22-2.5 VZ	22	17.0	2.50	333	288
PR 25-2.5 VZ	25	20.0	2.50	293	256
PR 28-2.5 VZ	28	23.0	2.50	261	231
PR 30-2.5 VZ	30	25.0	2.50	244	217
PR 38-2.5 VZ	38	23.0	2.50	181	163
PR 20-3 VZ	20	14.0	3.00	433	364
PR 25-3 VZ	25	19.0	3.0	347	299
PR 28-3 VZ	28	22.0	3.0	309	270
PR 30-3 VZ	30	24.0	3.0	289	253
PR 38-3 VZ	38	32.0	3.0	222	198
PR 42-3 VZ	42	36.0	3.0	193	174
PR 20-3.5 VZ	20	13	3.5	-	-
PR 25-4 VZ	25	17	4.0	472	393
PR 30-4 VZ	30	22.0	4.0	393	334
PR 35-4 VZ	35	27.0	4.0	331	286
PR 38-4 VZ	38	30.0	4.0	305	266
PR 30-5 VZ	30	20	5	498	411
PR 38-5 VZ	38	28.0	5.0	387	330
PR 38-6 VZ	38	26.0	6.0	469	391

公制精密钢管

材料: 不锈钢 1.4301 (304不锈钢)

描述: 模拟计算参照 DIN 2413 (draft)

载荷 I: 静压力

载荷 III: 压力强度范围 $P = \text{bar}$

材料特性值: $K 218 \text{ (N/mm}^2\text{)}$

安全系数: $S 1.5$

永久疲劳强度: $\dot{O}Sch/D 175 \text{ (N/mm}^2\text{)}$

公差: DIN 10305-5

蠕变极限参照 DIN 10216-5 Rp 1.0 up to 50° C.

永久疲劳强度参照 1.4571 (316Ti) 特性值减少。

备注: 下面所列的压力是针对直钢管的。针对弯曲的钢管其壁厚根据标准 DIN 2413 or DIN EN 13480-4 计算。

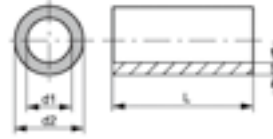

PRV1



订货号	Ød2 mm	Ød1 mm	S mm	I 静载荷 bar	III 动载荷 bar
PR 30-5 V1	30.0	20.0	5.00	-	-
PR 04-1 V1	4.0	2.0	1.00	558	376
PR 05-1 V1	5.0	3.0	1.00	447	311
PR 06-1 V1	6.0	4.0	1.00	372	265
PR 06-1.5 V1	6.0	3.0	1.50	-	-
PR 08-1 V1	8.0	6.0	1.00	279	204
PR 08-1.5 V1	8.0	5.0	1.50	460	319
PR 10-1 V1	10.0	8.0	1.00	223	166
PR 10-1.5 V1	10.0	7.0	1.50	369	262
PR 12-1 V1	12.0	10.0	1.00	186	140
PR 12-1.5 V1	12.0	9.0	1.50	307	223
PR 12-2 V1	12.0	8.0	2.00	428	299
PR 14-2 V1	14.0	10.0	2.00	367	261
PR 14-3 V1	14.0	8.0	3.00	-	-
PR 15-1.5 V1	15.0	12.0	1.50	246	182
PR 16-1 V1	16.0	14.0	1.00	-	-
PR 16-2 V1	16.0	12.0	2.00	321	232
PR 18-1 V1	18.0	16.0	1.00	135	104
PR 18-1.5 V1	18.0	15.0	1.50	216	161

订货号	Ød2 mm	Ød1 mm	S mm	I 静载荷 bar	III 动载荷 bar
PR 18-2 V1	18.0	14.0	2.00	297	216
PR 20-2 V1	20.0	16.0	2.00	257	189
PR 22-1 V1	22.0	20.0	1.00	110	85
PR 22-1.5 V1	22.0	19.0	1.50	176	133
PR 22-2 V1	22.0	18.0	2.00	233	173
PR 25-5 V1	25.0	15.0	5.00	554	373
PR 28-1 V1	28.0	26.0	1.00	87	67
PR 28-2 V1	28.0	24.0	2.00	191	143
PR 28-3 V1	28.0	22.0	3.00	287	210
PR 28-4 V1	28.0	20.0	4.00	-	-
PR 30-2 V1	30.0	26.0	2.00	178	134
PR 30-3 V1	30.0	24.0	3.00	-	-
PR 30-4 V1	30.0	22.0	4.00	-	-
PR 40-5 V1	40.0	30.0	5.00	337	243
PR 50-1.5 V1	50.0	47.0	1.50	63	50
PR 50-2 V1	50.0	46.0	2.00	93	72
PR 57-2 V1	57.0	53.0	2.00	76	59
PR 70-2 V1	70.0	66.0	2.00	-	-

公制精密钢管

材料: 不锈钢 1.4541 (321不锈钢)

描述: 模拟计算参照 DIN 2413 (draft)

载荷 I: 静压力

载荷 III: 压力强度范围 $P = \text{bar}$

材料特性值: $K 222 \text{ (N/mm}^2\text{)}$

安全系数: $S 1.5$

永久疲劳强度: $\dot{O}Sch/D 180 \text{ (N/mm}^2\text{)}$

公差: DIN 10305-5

蠕变极限参照 DIN 10216-5 Rp 1.0 up to 50° C.

永久疲劳强度参照 1.4571 (316Ti) 特性值减少。

备注: 下面所列的压力是针对直钢管的。针对弯曲的钢管其壁厚根据标准 DIN 2413 or DIN EN 13480-4 计算。

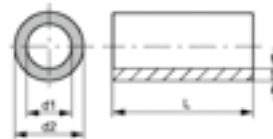

PRV2



订货号	Ød2 mm	Ød1 mm	S mm	I 静载荷 bar	III 动载荷 bar
PR 04-1 V 2	4.0	2.00	1.00	567	387
PR 06-1 V 2	6.0	4.00	1.00	379	272
PR 08-1 V 2	8.0	6.00	1.00	284	210
PR 10-1 V 2	10.0	8.00	1.00	227	171
PR 12-1 V 2	12.0	10.00	1.00	189	144
PR 14-1 V 2	14.0	12.00	1.00	162	125
PR 15-1 V 2	15.0	13.00	1.00	165	127
PR 16-1 V 2	16.0	14.00	1.00	155	119
PR 18-1 V 2	18.0	16.00	1.00	138	107
PR 20-1 V 2	20.0	18.00	1.00	124	96
PR 22-1 V 2	22.0	20.00	1.00	113	88
PR 28-1 V 2	28.0	26.00	1.00	88	69
PR 08-1.5 V 2	8.0	5.00	1.50	469	328
PR 10-1.5 V 2	10.0	7.00	1.50	375	270
PR 12-1.5 V 2	12.0	9.00	1.50	313	229
PR 15-1.5 V 2	15.0	12.00	1.50	250	187
PR 16-1.5 V 2	16.0	13.00	1.50	234	176
PR 18-1.5 V 2	18.0	15.00	1.50	220	166
PR 20-1.5 V 2	20.0	17.00	1.50	187	143
PR 22-1.5 V 2	22.0	19.00	1.50	180	137
PR 23-1.5 V 2	23.0	20.00	1.50	163	125
PR 30-1.5 V 2	30.0	27.00	1.50	132	102
PR 32-1.5 V 2	32.0	29.00	1.50	110	86
PR 35-1.5 V 2	35.0	32.00	1.50	101	79
PR 40-1.5 V 2	40.0	37.00	1.50	87	69
PR 10-2 V 2	10.0	6.00	2.00	523	360
PR 12-2 V 2	12.0	8.00	2.00	436	308

订货号	Ød2 mm	Ød1 mm	S mm	I 静载荷 bar	III 动载荷 bar
PR 14-2 V 2	14.0	10.00	2.00	374	269
PR 15-2 V 2	15.0	11.00	2.00	349	253
PR 16-2 V 2	16.0	12.00	2.00	327	239
PR 18-2 V 2	18.0	14.00	2.00	302	222
PR 20-2 V 2	20.0	16.00	2.00	261	195
PR 22-2 V 2	22.0	18.00	2.00	238	178
PR 25-2 V 2	25.0	21.00	2.00	217	164
PR 28-2 V 2	28.0	24.00	2.00	194	147
PR 30-2 V 2	30.0	26.00	2.00	181	138
PR 32-2 V 2	32.0	28.00	2.00	157	121
PR 34-2 V 2	34.0	30.00	2.00	147	114
PR 38-2 V 2	38.0	34.00	2.00	132	102
PR 42-2 V 2	42.0	38.00	2.00	112	88
PR 54-2 V 2	54.0	50.00	2.00	82	64
PR 25-2.5 V 2	25.0	20.00	2.50	277	205
PR 18-2.5 V 2	18.0	13.00	2.50	373	268
PR 20-2.5 V 2	20.0	15.00	2.50	-	-
PR 22-2.5 V 2	22.0	17.00	2.50	-	-
PR 28-2.5 V 2	28.0	23.00	2.50	247	185
PR30-2.5 V 2	30.0	25.00	2.50	-	-
PR 20-3 V 2	20.0	14.00	3.00	420	298
PR 25-3 V 2	25.0	19.00	3.00	336	244
PR 28-3 V 2	28.0	22.00	3.00	292	216
PR 30-3 V 2	30.0	24.00	3.00	273	202
PR 38-3 V 2	38.0	32.00	3.00	210	159
PR 30-4 V 2	30.0	22.00	4.00	371	267
PR30-5 V 2	30.0	20.00	5.00	496	347

公制精密钢管

材料: 不锈钢 1.4571 (不锈钢316Ti)
 描述: 模拟计算参照 DIN 2413 (draft)
 载荷 I: 静压力
 载荷 III: 压力强度范围 P = bar
 材料特性值: K 234 (N/mm²)
 安全系数: S 1.5
 永久疲劳强度: ÓSch/D 190 (N/mm²)

公差: DIN 10305-5
 蠕变极限参照 DIN 10216-5 Rp 1.0
 up to 50 ° C
 备注: 下面所列的压力是针对直钢管的。
 针对弯曲的钢管其壁厚根据标准 DIN 2413 or DIN EN 13480-4计算

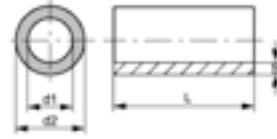

PRV4

订货号	Ød2 mm	Ød1 mm	S mm	I 静载荷 bar	III 动载荷 bar
PR 10-0.5 V 4	10.0	9.0	0.5	-	-
PR 04-1 V 4	4.0	2.0	1.0	600	408
PR 06-1 V 4	6.0	4.0	1.0	400	287
PR 08-1 V 4	8.0	6.0	1.0	300	222
PR 10-1 V 4	10.0	8.0	1.0	240	181
PR 12-1 V 4	12.0	10.0	1.0	200	152
PR 15-1 V 4	15.0	13.0	1.0	174	134
PR 18-1 V 4	18.0	16.0	1.0	145	112
PR 06-1.5 V 4	6.0	3.0	1.5	660	442
PR 08-1.5 V 4	8.0	5.0	1.5	495	347
PR 10-1.5 V 4	10.0	7.0	1.5	396	285
PR 12-1.5 V 4	12.0	9.0	1.5	330	242
PR 14-1.5 V 4	14.0	11.0	1.5	283	210
PR 15-1.5 V 4	15.0	12.0	1.5	264	197
PR 16-1.5 V 4	16.0	13.0	1.5	261	195
PR 18-1.5 V 4	18.0	15.0	1.5	232	175
PR 22-1.5 V 4	22.0	19.0	1.5	190	145
PR 25-1.5 V 4	25.0	22.0	1.5	167	128
PR 28-1.5 V 4	28.0	25.0	1.5	149	115
PR 35-1.5 V 4	35.0	32.0	1.5	-	-
PR 06-2 V 4	6.0	2.0	2.0	-	-
PR 08-2 V 4	8.0	4.0	2.0	690	458
PR 10-2 V 4	10.0	6.0	2.0	552	380
PR 12-2 V 4	12.0	8.0	2.0	460	325
PR 14-2 V 4	14.0	10.0	2.0	394	284
PR 15-2 V 4	15.0	11.0	2.0	368	267
PR 16-2 V 4	16.0	12.0	2.0	345	252
PR 18-2 V 4	18.0	14.0	2.0	318	234

订货号	Ød2 mm	Ød1 mm	S mm	I 静载荷 bar	III 动载荷 bar
PR 20-2 V 4	20.0	16.0	2.0	287	213
PR 22-2 V 4	22.0	18.0	2.0	260	195
PR 25-2 V 4	25.0	21.0	2.0	229	173
PR 28-2 V 4	28.0	24.0	2.0	205	156
PR 30-2 V 4	30.0	26.0	2.0	191	146
PR 35-2 V 4	35.0	31.0	2.0	151	117
PR 42-2 V 4	42.0	38.0	2.0	118	92
PR 14-2.5 V 4	14.0	9.0	2.5	505	353
PR 16-2.5 V 4	16.0	11.0	2.5	442	314
PR 18-2.5 V 4	18.0	13.0	2.5	393	283
PR 20-2.5 V 4	20.0	15.0	2.5	354	258
PR 22-2.5 V 4	22.0	17.0	2.5	321	236
PR 25-2.5 V 4	25.0	20.0	2.5	292	216
PR 28-2.5 V 4	28.0	23.0	2.5	260	195
PR 30-2.5 V 4	30.0	25.0	2.5	243	183
PR 35-2.5 V 4	35.0	30.0	2.5	196	149
PR 12-3 V 4	12.0	6.0	3.0	694	461
PR 16-3 V 4	16.0	10.0	3.0	540	373
PR 20-3 V 4	20.0	14.0	3.0	432	308
PR 22-3 V 4	22.0	16.0	3.0	392	283
PR 25-3 V 4	25.0	19.0	3.0	345	252
PR 30-3 V 4	30.0	24.0	3.0	288	214
PR 42-3 V 4	42.0	36.0	3.0	193	147
PR 30-4 V 4	30.0	22.0	4.0	392	282
PR 38-4 V 4	38.0	30.0	4.0	303	224
PR 30-5 V 4	30.0	20.0	5.0	496	347
PR 35-5 V 4	35.0	25.0	5.0	-	-
PR 38-5 V 4	38.0	28.0	5.0	385	278

产品

软管总成

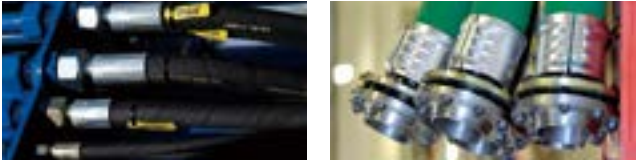

HANSA-FLEX 提供各种液压软管及总成，以及各种工业软管，包括消防、水处理、压缩机、燃油、化工、食品饮料等行业。

硬管接头



HANSA-FLEX 提供高品质的硬管接头，包括卡套式、焊接式、扩口式等，材质有碳钢和不锈钢等，上海物流仓库备有库存。

液压附件

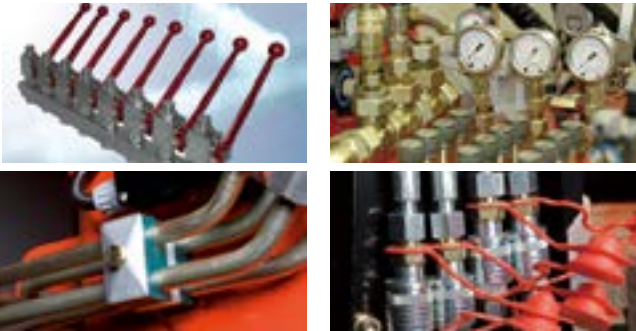

HANSA-FLEX 一站式服务为客户提供各种液压附件，包括球阀、快速接头、压力表、测压接头、法兰、管夹以及非标产品等。

硬管总成



HANSA-FLEX 在上海设有弯管中心，可根据客户要求定制弯管总成，以及提供管接头的预处理、焊接等总成服务。

液压系统



HANSA-FLEX 积累了丰富的应用和现场经验，能够为客户定制各种液压站。

服务

除了产品外，HANSA-FLEX 也为客户提供各种现场服务，我们就在您身边。

HANSA-FLEX 为客户提供的现场服务，包括测绘、安装、维修等。



现场服务



现场液压车间



快速服务车



现场维修

行业应用



风电行业



轨道交通



船舶海事



造纸行业



农业机械



航空航天

HANSA-FLEX 在中国

汉萨福莱柯思液压技术(上海)有限公司

上海市浦东新区临港新城飞舟路500号

电话: +86-21-3821 6000

传真: +86-21-3821 6035

网址: www.hansa-flex.com

www.hansa-flex.com.cn

上海分公司

上海浦东新区沪南路2419弄31号505-506室

电话: +86-21-5042 1706, 5042 1708

传真: +86-21-5258 1219

常州分公司

常州市经济开发区轨道交通产业园3号楼一层南侧

电话: +86-519-8548 6780

传真: +86-519-8548 6806

北京分公司

北京市朝阳区光华路8号甲和乔大厦C1201室

电话: +86-10-6581 6578

传真: +86-10-6581 5120

成都分公司

成都市成华区猛追湾横街188号世茂玉锦湾2号楼2611号

电话: +86-28-8628 2995

传真: +86-28-8628 2995-808

广州分公司

广州市黄埔区开创大道1936号萝岗奥园广场

H6栋2818-2819室

电话: +86-20-8349 7108, 8349 7308

传真: +86-20-8349 7306

青岛分公司

青岛市城阳区正阳中路166号财富中心9号楼606室

电话: +86-532-6688 5057

传真: +86-532-6688 5059



网站



微信公众号



在线商城



在线样本

服务热线: 400-1515-105